

DATABOOK

DISCRETE POWER DEVICES
5th EDITION



critterion (408) 988-6300

manufacturers representatives

3350 Scott Blvd., Bldg. 44, Santa Clara, CA 95051



DISCRETE POWER DEVICES
5th EDITION

ISSUED OCTOBER 1982

INTRODUCTION

This databook contains data sheets on the SGS-ATES range of discrete power devices for professional, industrial and consumer applications.

Selection guides are provided in the following pages to facilitate rapid identification of the most suitable device for the intended use.

The information on each product has been specially presented in order that the performance of the product can be readily evaluated within any required equipment design.

SGS-ATES GROUP OF COMPANIES

INTERNATIONAL HEADQUARTERS

SGS-ATES Componenti Elettronici SpA
Via C. Olivetti 2 - 20041 Agrate Brianza - Italy
Tel.: 039 - 65551
Telex: 330131-330141

BENELUX

SGS-ATES Componenti Elettronici SpA
Benelux Sales Office
B- 1180 Bruxelles
Winston Churchill Avenue, 122
Tel.: 02 - 3432439
Telex: 24149 B

DENMARK

SGS-ATES Scandinavia AB
Sales Office
2730 Herlev
Herlev Torv, 4
Tel.: 02 - 948533
Telex: 35411

EASTERN EUROPE

SGS-ATES Componenti Elettronici SpA
Export Sales Office
20041 Agrate Brianza - Italy
Via C. Olivetti, 2
Tel.: 039 - 6555287/6555207
Telex: 330131-330141

FRANCE

SGS-ATES France S.A.
75643 Paris Cedex 13
Résidence "Le Palatino"
17, Avenue de Choisy
Tel.: 01 - 5842730
Telex: 042 - 250938

WEST GERMANY

SGS-ATES Deutschland Halbleiter
Bauelemente GmbH
8018 Grafing bei München
Haidling, 17
Tel.: 08092-690
Telex: 05 27378
Sales Offices:
3012 Langenhagen
Hubertusstrasse, 7
Tel.: 0511 - 772075/7
Telex: 09 23195
8000 München 90
Tegernseer Landstr., 146
Tel.: 089 - 6925100
Telex: 05 215784
8500 Nürnberg 30
Ostendstr., 204
Tel.: 0911-572977/78/79
Telex: 0626243
7000 Stuttgart 80
Kalifenweg, 45
Tel.: 0711 - 713091/2
Telex: 07 255545

HONG KONG

SGS-ATES Singapore (Pte) Ltd.
9th Floor, Block N,
Kaiser Estate, Phase III,
11 Hok Yuen St.,
Hung Hom, Kowloon
Tel.: 3-644251/5
Telex: 63906 ESGIE HX

ITALY

SGS-ATES Componenti Elettronici SpA
Direzione Commerciale Italia
20149 Milano
Via Correggio, 1/3
Tel.: 02 - 4695651
Sales Office :
40128 Bologna
Via Corticella, 231
Tel.: 051 - 326684
00199 Roma
Piazza Gondar, 11
Tel.: 06 - 8392848/8312777

SINGAPORE

SGS-ATES Singapore (Pte) Ltd.
Singapore 1231
Lorong 4 & 6 - Toa Payoh
Tel.: 2531411
Telex: ESGIES RS 21412

SWEDEN

SGS-ATES Scandinavia AB
19501 Märsta
Box 144
Tel.: 0760 - 40120
Telex: 042 - 10932

SWITZERLAND

SGS-ATES Componenti Elettronici SpA
Swiss Sales Offices
6340 Baar
Oberneuhofstrasse, 2
Tel.: 042 - 315955
Telex: 864915
1218 Grand-Saconnex (Geneve)
Chemin François-Lehmann 22
Tel.: 022 - 986462/3
Telex: 28895

UNITED KINGDOM

SGS-ATES (United Kingdom) Ltd.
Aylesbury, Bucks
Planar House, Walton Street
Tel.: 0296 - 5977
Telex: 041 - 83245

U.S.A.

SGS-ATES Semiconductor Corporation
Scottsdale, AZ 85251
7117, East 3rd Avenue
Tel.: (602) 990-9553
Telex: SGS ATES SCOT 165808
75248 Dallas, TX
16970 Dallas North Parkway
Building 700, Suite 702
Tel.: (214) 733-1515
Des Plaines, IL 60018
2340, Des Plaines Ave Suite 309
Tel.: (312) 296-4035
Telex: 282547
Santa Clara, CA 95051
2700, Augustine Drive
Tel.: (408) 727-3404
Telex: 346402
Waltham, MA 02154
240, Bear Hill Road
Tel.: (617) 890-6688
Telex: 923495 WHA
Woodland Hills, CA 91367
6355, Topange Canyon Boulevard
Suite 220
Tel.: (213) 716-6600
Telex: 182863

TABLE OF CONTENTS

ALPHANUMERICAL INDEX	Page 4
SELECTION GUIDES BASED ON TECHNOLOGY AND PACKAGES	8
CROSS REFERENCE GUIDE	19
ALPHABETICAL LIST OF SYMBOLS	28
RATING SYSTEMS FOR ELECTRONIC DEVICES	31
QUALITY (SURE 3)	33
HANDLING OF POWER PLASTIC TRANSISTOR	34
ACCESSORIES AND MOUNTING INSTRUCTIONS	38
DATA-SHEETS	47

ALPHANUMERICAL INDEX

Type	Page	Type	Page	Type	Page
BD 175	48	BD 436	82	BD 911	120
BD 176	52	BD 437	78	BD 912	124
BD 177	48	BD 438	82	BDV 64	128
BD 178	52	BD 439	86	BDV 64A	128
BD 179	48	BD 440	90	BDV 64B	128
BD 180	52	BD 441	86	BDV 65	128
BD 233	56	BD 442	90	BDV 65A	128
BD 234	60	BD 533	94	BDV 65B	128
BD 235	56	BD 534	98	BDW 51	133
BD 236	60	BD 535	94	BDW 51A	133
BD 237	56	BD 536	98	BDW 51B	133
BD 238	60	BD 537	94	BDW 51C	133
BD 239	64	BD 538	98	BDW 52	138
BD 239A	64	BD 675A	102	BDW 52A	138
BD 239B	64	BD 676A	106	BDW 52B	138
BD 239C	64	BD 677	102	BDW 52C	138
BD 240	66	BD 677A	102	BDW 91	143
BD 240A	66	BD 678	106	BDW 92	147
BD 240B	66	BD 678A	106	BDW 93	151
BD 240C	66	BD 679	102	BDW 93A	151
BD 241	70	BD 679A	102	BDW 93B	151
BD 241A	70	BD 680	106	BDW 93C	151
BD 241B	70	BD 680A	106	BDW 94	156
BD 241C	70	BD 681	102	BDW 94A	156
BD 242	72	BD 682	106	BDW 94B	156
BD 242A	72	BD 705	110	BDW 94C	156
BD 242B	72	BD 706	115	BDX 53	161
BD 242C	72	BD 707	110	BDX 53A	161
BD 243	74	BD 708	115	BDX 53B	161
BD 243A	74	BD 709	110	BDX 53C	161
BD 243B	74	BD 710	115	BDX 53E	165
BD 243C	74	BD 711	110	BDX 53F	165
BD 244	76	BD 712	115	BDX 53S	169
BD 244A	76	BD 905	120	BDX 54	173
BD 244B	76	BD 906	124	BDX 54A	173
BD 244C	76	BD 907	120	BDX 54B	173
BD 433	78	BD 908	124	BDX 54C	173
BD 434	82	BD 909	120	BDX 54E	177
BD 435	78	BD 910	124	BDX 54F	177

Type	Page	Type	Page	Type	Page
BDX 54S	181	BU 408D	255	BUW 34	359
BDX 85	185	BU 426	267	BUW 35	359
BDX 85A	185	BU 426A	267	BUW 36	359
BDX 85B	185	BU 801	270	BUW 42	364
BDX 85C	185	BU 806	275	BUW 44	366
BDX 86	190	BU 807	275	BUW 45	366
BDX 86A	190	BU 810	281	BUW 46	366
BDX 86B	190	BU 910	285	BUX 10	371
BDX 86C	190	BU 911	285	BUX 11	377
BDX 87	195	BU 912	285	BUX 11N	383
BDX 87A	195	BU 920P	290	BUX 12	389
BDX 87B	195	BU 921P	290	BUX 13	395
BDX 87C	195	BU 922P	290	BUX 14	397
BDX 88	200	BU 930	293	BUX 20	399
BDX 88A	200	BU 930P	299	BUX 21	405
BDX 88B	200	BU 931	293	BUX 22	411
BDX 88C	200	BU 931P	299	BUX 40	417
BDY 57	205	BU 932	293	BUX 41	423
BDY 58	205	BU 932P	299	BUX 41N	429
BDY 90	208	BUR 50	301	BUX 42	435
BDY 91	208	BUR 51	307	BUX 43	441
BDY 92	208	BUR 52	313	BUX 44	443
BFX 34	210	BUT 13	319	BUX 46	445
BSS 44	214	BUT 13P	327	BUX 47	447
BDW 67	218	BUV 20	335	BUX 48	449
BDW 68	218	BUV 21	335	BUX 48A	449
BU 125	222	BUV 22	335	BUX 48B	449
BU 125S	226	BUV 23	338	BUX 48C	449
BU 325	230	BUV 24	338	BUX 80	459
BU 326	235	BUV 25	338	BUX 84	464
BU 326A	240	BUV 46	341	BUY 18S	466
BU 326S	245	BUV 47	343	BUY 47	469
BU 406	249	BUV 47A	343	BUY 48	469
BU 406D	255	BUV 48	346	BUY 49P	474
BU 406H	249	BUV 48A	346	BUY 49S	476
BU 407	261	BUW 11	348	BUY 68	480
BU 407D	255	BUW 12	351	BUY 69A	484
BU 407H	261	BUW 12A	351	BUY 69B	484
BU 408	249	BUW 32	354	BUY 69C	484

ALPHANUMERICAL INDEX (continued)

Type	Page	Type	Page	Type	Page
D44 C1	487	MJ 10004P	501	TIP 32A	530
D44 C2	487	MJ 10005	501	TIP 32B	530
D44 C3	487	MJ 10005P	501	TIP 32C	530
D44 C4	487	MJ 11011	504	TIP 41	532
D44 C5	487	MJ 11012	504	TIP 41A	532
D44 C6	487	MJ 11013	504	TIP 41B	532
D44 C7	487	MJ 11014	504	TIP 41C	532
D44 C8	487	MJ 11015	504	TIP 42	534
D44 C9	487	MJ 11016	504	TIP 42A	534
D44 C10	487	MJE 340	506	TIP 42B	534
D44 C11	487	MJE 350	506	TIP 42C	534
D44 C12	487	MJE 700	508	TIP 47	536
D44 H1	489	MJE 701	508	TIP 48	536
D44 H2	489	MJE 702	508	TIP 49	536
D44 H4	489	MJE 703	508	TIP 50	536
D44 H5	489	MJE 800	508	TIP 51	542
D44 H7	489	MJE 801	508	TIP 52	542
D44 H8	489	MJE 802	508	TIP 53	542
D44 H10	489	MJE 803	508	TIP 54	542
D44 H11	489	MJE 13002	511	TIP 100	545
D44 Q1	491	MJE 13003	511	TIP 101	545
D44 Q3	491	MJE 13004	517	TIP 102	545
D44 Q5	491	MJE 13005	517	TIP 105	547
MJ 900	493	MJE 13006	522	TIP 106	547
MJ 901	493	MJE 13007	522	TIP 107	547
MJ 1000	493	MJE 13007A	522	TIP 110	549
MJ 1001	493	TIP 29	524	TIP 111	549
MJ 2500	495	TIP 29A	524	TIP 112	549
MJ 2501	495	TIP 29B	524	TIP 115	551
MJ 2955	497	TIP 29C	524	TIP 116	551
MJ 3000	495	TIP 30	526	TIP 117	551
MJ 3001	495	TIP 30A	526	TIP 120	553
MJ 4030	499	TIP 30B	526	TIP 121	553
MJ 4031	499	TIP 30C	526	TIP 122	553
MJ 4032	499	TIP 31	528	TIP 125	558
MJ 4033	499	TIP 31A	528	TIP 126	558
MJ 4034	499	TIP 31B	528	TIP 127	558
MJ 4035	499	TIP 31C	528	TIP 130	563
MJ 10004	501	TIP 32	530	TIP 131	563

Type	Page	Type	Page	Type	Page
TIP 132	563	2N 5336	615	2N 6123	675
TIP 135	565	2N 5337	615	2N 6124	679
TIP 136	565	2N 5338	615	2N 6125	679
TIP 137	565	2N 5339	615	2N 6126	679
TIP 140	567	2N 5415	620	2N 6282	683
TIP 141	567	2N 5416	620	2N 6283	683
TIP 142	567	2N 5671	624	2N 6284	683
TIP 145	567	2N 5672	624	2N 6285	683
TIP 146	567	2N 5679	628	2N 6286	683
TIP 147	567	2N 5680	628	2N 6287	683
2N 3055E	572	2N 5681	630	2N 6288	673
2N 3439	576	2N 5682	630	2N 6290	673
2N 3440	576	2N 5875	632	2N 6292	673
2N 3713	580	2N 5876	632	2N 6354	685
2N 3714	580	2N 5877	637	2N 6386	690
2N 3715	580	2N 5878	637	2N 6387	690
2N 3716	580	2N 6032	642	2N 6388	690
2N 3789	584	2N 6033	642	2N 6486	693
2N 3790	584	2N 6034	647	2N 6487	693
2N 3791	584	2N 6035	647	2N 6488	693
2N 3792	584	2N 6036	647	2N 6489	696
2N 4234	588	2N 6037	651	2N 6490	696
2N 4235	588	2N 6038	651	2N 6491	696
2N 4236	588	2N 6039	651	2N 6496	595
2N 4895	591	2N 6050	655	2N 6544	699
2N 4896	591	2N 6051	655	2N 6545	699
2N 4897	591	2N 6052	655	2N 6546	702
2N 5038	595	2N 6053	660	2N 6547	702
2N 5039	595	2N 6054	660	2N 6702	705
2N 5151	601	2N 6055	664		
2N 5152	604	2N 6056	664		
2N 5153	601	2N 6057	668		
2N 5154	604	2N 6058	668		
2N 5190	607	2N 6059	668		
2N 5191	607	2N 6107	673		
2N 5192	607	2N 6109	673		
2N 5193	611	2N 6111	673		
2N 5194	611	2N 6121	675		
2N 5195	611	2N 6122	675		

SELECTION GUIDES BASED ON TECHNOLOGY AND PACKAGES

SGS power transistors cover a wide range of technologies optimized for almost every application. These include epitaxial base (medium voltage, high ruggedness, general purpose) epitaxial planar (high speed with good voltage capability) multiepitaxial planar (high current switching) and multiepitaxial mesa (high voltage-high power switching).

A wide choice of packages are available.

In order to be easy to use following power transistor selector guides cover only a part of the complete range. Other voltage ratings and gain selections shown on the full data sheets are equally available.

Many older devices which are less popular for new designs are also in production. Your nearest SGS sales office or distributor has full details available on request.

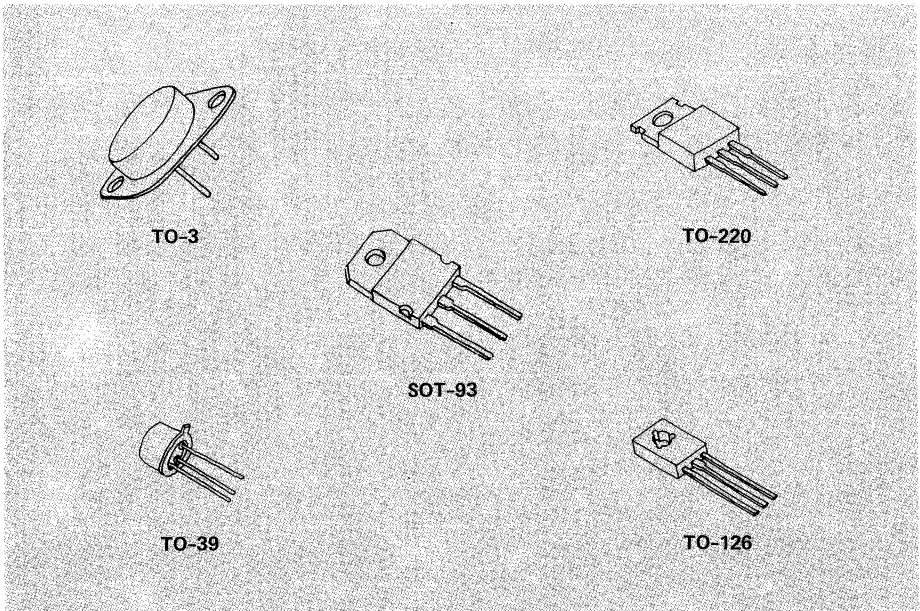

EPITAXIAL BASE – I_{CM} 1 to 15A; V_{CE0} 22 to 180V

NPN and PNP types
 (perfect complementary pairs)
 Medium V_{CE0} range (22 to 100V)
 Medium switching speed
 Medium f_T (2 to 20 MHz)
 High ruggedness
 Monolithic Darlington capability

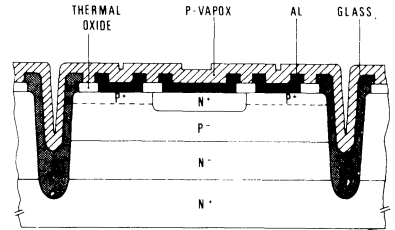

EPITAXIAL BASE

I_C (A)	V_{CBO} (V)	V_{CEO} (V)	P_{tot} (W)	Package	NPN	PNP	h_{FE} min	I_C/V_{CE} (A/V)	V_{CEsat} max (V)	I_C/I_B (A/mA)	
1	40	40	30	TO-220	TIP29	TIP30	15	1.0/4	0.70	1.0/125	
1	60	60	30	TO-220	TIP29A	TIP30A	15	1.0/4	0.70	1.0/125	
1	80	80	30	TO-220	TIP29B	TIP30B	15	1.0/4	0.70	1.0/125	
1	100	100	30	TO-220	TIP29C	TIP30C	15	1.0/4	0.70	1.0/125	
2	45	45	25	TO-126	BD233	BD234	25	1.0/2	0.60	1.0/100	
2	55	45	30	TO-220	BD239	BD240	15	1.0/4	0.70	1.0/200	
2	60	60	25	TO-126	BD235	BD236	25	1.0/2	0.60	1.0/100	
2	70	60	30	TO-220	BD239A	BD240A	15	1.0/4	0.70	1.0/200	
2	100	80	25	TO-126	BD237	BD238	25	1.0/2	0.60	1.0/100	
2	90	80	30	TO-220	BD239B	BD240B	15	1.0/4	0.70	1.0/200	
2	115	100	30	TO-220	BD239C	BD240C	15	1.0/4	0.70	1.0/200	
*	2	60	60	50	TO-220	TIP110	TIP115	1000	1.0/4	2.50	2.0/8
*	2	80	80	50	TO-220	TIP111	TIP116	1000	1.0/4	2.50	2.0/8
*	2	100	100	50	TO-220	TIP112	TIP117	1000	1.0/4	2.50	2.0/8
3	45	45	30	TO-126	BD175	BD176	15	1.0/2	0.80	1.0/100	
3	60	60	30	TO-126	BD177	BD178	15	1.0/2	0.80	1.0/100	
3	80	80	30	TO-126	BD179	BD180	15	1.0/2	0.80	1.0/100	
3	55	45	40	TO-220	BD241	BD242	25	1.0/4	1.20	3.0/600	
3	40	40	40	TO-220	TIP31	TIP32	25	1.0/4	1.20	3.0/375	
3	70	60	40	TO-220	BD241A	BD242A	25	1.0/4	1.20	3.0/600	
3	60	60	40	TO-220	TIP31A	TIP32A	25	1.0/4	1.20	3.0/375	
3	90	80	40	TO-220	BD241B	BD242B	25	1.0/4	1.20	3.0/600	
3	80	80	40	TO-220	TIP31B	TIP32B	25	1.0/4	1.20	3.0/375	
3	115	100	40	TO-220	BD241C	BD242C	25	1.0/4	1.20	3.0/600	
3	100	100	40	TO-220	TIP31C	TIP32C	25	1.0/4	1.20	3.0/375	

* Darlington types.

SELECTION GUIDES BASED ON TECHNOLOGY AND PACKAGES

(continued)

EPITAXIAL BASE (continued)

I_C (A)	V_{CBO} (V)	V_{CEO} (V)	P_{tot} (W)	Package	NPN	PNP	h_{FE} min	I_C/V_{CE} (A/V)	V_{CEsat} max (V)	I_C/I_B (A/mA)
	4	40	40	TO-126	2N5190	2N5193	25	1.50/2	0.60	1.50/150
*	4	60	60	TO-126	BD677	BD678	750	1.50/3	2.50	1.50/6
*	4	80	80	TO-126	BD679	BD680	750	1.50/3	2.50	1.50/6
	4	80	40	TO-126	2N5192	2N5195	20	1.50/2	0.60	1.50/150
*	4	100	100	TO-126	BD681	BD682	750	1.50/3	2.50	1.50/6
	4	22	22	TO-126	BD433	BD434	50	2.0/1	0.50	2.0/200
	4	32	32	TO-126	BD435	BD436	50	2.0/1	0.50	2.0/200
	4	45	45	TO-126	BD437	BD438	40	2.0/1	0.60	2.0/200
*	4	45	45	TO-126	BD675A	BD676A	750	2.0/3	2.80	2.0/8
	4	45	50	TO-220	BD533	BD534	25	2.0/2	0.80	2.0/200
	4	60	36	TO-126	BD439	BD440	25	2.0/1	0.80	2.0/200
*	4	60	40	TO-126	BD677A	BD678A	750	2.0/3	2.80	2.0/8
	4	60	50	TO-220	BD535	BD536	25	2.0/2	0.80	2.0/200
	4	80	36	TO-126	BD441	BD442	15	2.0/1	0.80	2.0/200
*	4	80	40	TO-126	BD679A	BD680A	750	2.0/3	2.80	2.0/8
	4	80	50	TO-220	BD537	BD538	15	2.0/2	0.80	2.0/200
*	4	180	180	TO-39	BDW91	BDW92	1000	2.0/5	2.0	2.0/4
	5	60	65	TO-220	TIP120	TIP125	1000	3.0/3	2.0	3.0/12
*	5	80	65	TO-220	TIP121	TIP126	1000	3.0/3	2.0	3.0/12
*	5	100	65	TO-220	TIP122	TIP127	1000	3.0/3	2.0	3.0/12
*	6	45	50	TO-220	BDW23	BDW24	750	2.0/3	2.0	2.0/8
*	6	60	50	TO-220	BDW23A	BDW24A	750	2.0/3	2.0	2.0/8
*	6	80	50	TO-220	BDW23B	BDW24B	750	2.0/3	2.0	2.0/8
*	6	100	50	TO-220	BDW23C	BDW24C	750	2.0/3	2.0	2.0/8
*	6	140	60	TO-220	BDX53E	BDX54E	500	2.0/5	2.0	2.0/10
*	6	150	15	TO-39	BDX53S	BDX54S	500	2.0/5	2.0	2.0/8
*	6	160	60	TO-220	BDX53F	BDX54F	500	2.0/5	2.0	2.0/10
	6	45	65	TO-220	BD243	BD244	15	3.0/4	1.50	6.0/1000
	6	40	65	TO-220	TIP41	TIP42	15	3.0/4	1.50	6.0/600
	6	60	65	TO-220	BD243A	BD244A	15	3.0/4	1.50	6.0/1000
	6	60	65	TO-220	TIP41A	TIP42A	15	3.0/4	1.50	6.0/600
	6	80	65	TO-220	BD243B	BD244B	15	3.0/4	1.50	6.0/1000
	6	80	65	TO-220	TIP41B	TIP42B	15	3.0/4	1.50	6.0/600
	6	100	65	TO-220	BD243C	BD244C	15	3.0/4	1.50	6.0/1000
	6	100	65	TO-220	TIP41C	TIP42C	15	3.0/4	1.50	6.0/600

* Darlingtons types.

EPITAXIAL BASE (continued)

I_C (A)	V_{CBO} (V)	V_{CEO} (V)	P_{tot} (W)	Package	NPN	PNP	h_{FE} min	I_C/V_{CE} (A/V)	V_{CEsat} max (V)	I_C/I_B (A/mA)
7	80	70	40	TO-220	2N6292	2N6107	30	4.0/2	1.0	2.0/200
7	40	30	40	TO-220	2N6288	2N6111	30	4.0/3	1.0	3.0/300
* 8	40	40	65	TO-220	2N6386		1000	3.0/3	2.0	3.0/6
* 8	45	45	60	TO-220	BDX53	BDX54	750	3.0/3	2.0	3.0/12
* 8	60	60	60	TO-220	BDX53A	BDX54A	750	3.0/3	2.0	3.0/12
* 8	60	60	90	TO-3	MJ1000	MJ900	1000	3.0/3	2.0	3.0/12
* 8	80	80	60	TO-220	BDX53B	BDX54B	750	3.0/3	2.0	3.0/12
* 8	80	80	90	TO-3	MJ1001	MJ901	1000	3.0/3	2.0	3.0/12
* 8	100	100	60	TO-220	BDX53C	BDX54C	750	3.0/3	2.0	3.0/12
* 8	60	60	70	TO-220	TIP130	TIP135	1000	4.0/4	2.0	4.0/16
* 8	80	80	70	TO-220	TIP131	TIP136	1000	4.0/4	2.0	4.0/16
* 8	100	100	70	TO-220	TIP132	TIP137	1000	4.0/4	2.0	4.0/16
* 10	45	45	100	TO-3	BDX85	BDX86	1000	3.0/3	2.0	4.0/16
* 10	60	60	100	TO-3	BDX85A	BDX86A	1000	3.0/3	2.0	4.0/16
* 10	80	80	100	TO-3	BDX85B	BDX86B	1000	3.0/3	2.0	4.0/16
* 10	100	100	100	TO-3	BDX85C	BDX86C	1000	3.0/3	2.0	4.0/16
* 10	60	60	65	TO-220	2N6387		1000	5.0/3	2.0	5.0/10
* 10	60	60	150	TO-3	MJ3000	MJ2500	1000	5.0/3	2.0	5.0/20
10	60	60	150	TO-3	2N5877	2N5875	20	4.0/4	1.0	5.0/500
10	80	60	150	TO-3	2N3715	2N3791	30	3.0/2	0.80	5.0/500
* 10	80	80	65	TO-220	2N6388		1000	5.0/3	2.0	5.0/10
* 10	80	80	150	TO-3	MJ3001	MJ2501	1000	5.0/3	2.0	5.0/20
10	80	80	150	TO-3	2N5878	2N5876	20	4.0/4	1.0	5.0/500
10	100	80	150	TO-3	2N3716	2N3792	30	3.0/2	0.80	5.0/500
12	45	45	75	TO-220	BD705	BD706	20	4.0/4	1.0	4.0/400
12	60	60	75	TO-220	BD707	BD708	15	4.0/4	1.0	4.0/400
12	80	80	75	TO-220	BD709	BD710	15	4.0/4	1.0	4.0/400
12	100	100	75	TO-220	BD711	BD712	15	4.0/4	1.0	4.0/400
* 12	45	45	80	TO-220	BDW93	BDW94	750	5.0/3	2.0	5.0/20
* 12	60	60	80	TO-220	BDW93A	BDW94A	750	5.0/3	2.0	5.0/20
* 12	80	80	80	TO-220	BDW93B	BDW94B	750	5.0/3	2.0	5.0/20
* 12	100	100	80	TO-220	BDW93C	BDW94C	750	5.0/3	2.0	5.0/20
* 12	45	45	120	TO-3	BDX87	BDX88	1000	5.0/3	2.0	6.0/24
* 12	60	60	120	TO-3	BDX87A	BDX88A	1000	5.0/3	2.0	6.0/24

* Darlington types.

SELECTION GUIDES BASED ON TECHNOLOGY AND PACKAGES

(continued)

EPITAXIAL BASE (continued)

I_C (A)	V_{CBO} (V)	V_{CEO} (V)	P_{tot} (W)	Package	NPN	PNP	h_{FE} min	I_C/V_{CE} (A/V)	V_{CEsat} max (V)	I_C/I_B (A/mA)
* 12	80	80	120	TO-3	BDX87B	BDX88B	1000	5.0/3	2.0	6.0/24
* 12	100	100	120	TO-3	BDX87C	BDX88C	1000	5.0/3	2.0	6.0/24
15	100	60	115	TO-3	2N3055E	MJ2955	20	4.0/4	1.1	4.0/400
15	45	45	90	TO-220	BD905	BD906	15	5.0/4	1.0	5.0/500
15	45	45	125	TO-3	BDW51	BDW52	20	5.0/4	1.0	5.0/500
15	60	60	90	TO-220	BD907	BD908	15	5.0/4	1.0	5.0/500
15	60	60	125	TO-3	BDW51A	BDW52A	20	5.0/4	1.0	5.0/500
15	80	80	90	TO-220	BD909	BD910	15	5.0/4	1.0	5.0/500
15	80	80	125	TO-3	BDW51B	BDW52B	20	5.0/4	1.0	5.0/500
15	100	100	90	TO-220	BD911	BD912	15	5.0/4	1.0	5.0/500
15	100	100	125	TO-3	BDW51C	BDW52C	20	5.0/4	1.0	5.0/500

* Darlington types.

EPITAXIAL PLANAR – I_{CM} 0.5 to 2A; V_{CE0} 45 to 350V

NPN and PNP types
 Good voltage capability (V_{CES} up to 400V)
 Low saturation voltage
 Low leakage
 Very high f_T (up to 100 MHz)
 Very high speed
 Moderate ruggedness
 Total base-collector passivation

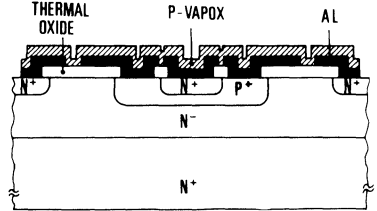

EPITAXIAL PLANAR

I_C (A)	V_{CBO} (V)	V_{CEO} (V)	P_{tot} (W)	Package	NPN	PNP	h_{FE} min	I_C/V_{CE} (A/V)	V_{CESat} max (V)	I_C/I_B (A/MA)
0.5	300	300	20	TO-126	MJE340	MJE350	30	0.05/10	—	—
1	45	45	12	TO-126	BD135	BD136	40	0.15/2	0.5	0.50/50
1	60	60	12	TO-126	BD137	BD138	40	0.15/2	0.5	0.50/50
1	80	80	12	TO-126	BD139	BD140	40	0.15/2	0.5	0.50/50
1	120	120	10	TO-39	2N5682	2N5680	40	0.25/2	1.0	0.50/50
1	200	200	10	TO-39		2N5415	30	0.05/10	2.5	0.05/5
1	300	250	10	TO-39	2N3440		40	0.02/10	0.5	0.05/4
1	350	300	10	TO-39		2N5416	30	0.05/10	2.5	0.05/5
1	450	350	10	TO-39	2N3439		40	0.02/10	0.5	0.05/4
1.5	120	120	5	TO-39	BSW67		15	1.0/5	1.0	1.0/150
1.5	150	150	5	TO-39	BSW68		15	1.0/5	1.0	1.0/150
2	50	45	25	TO-126	BD375	BD376	40	0.15/2	1.0	1.0/100
2	75	60	25	TO-126	BD377	BD378	40	0.15/2	1.0	1.0/100
2	100	80	25	TO-126	BD379	BD380	40	0.15/2	1.0	1.0/100
3	250	150	10	TO-39	BU125S		30	0.25/3	1.5	0.50/50
3	200	200	25	TO-126	BU325		30	0.50/5	1.5	0.50/50
3	250	200	10	TO-39	BUY49S		40	0.50/5	0.2	0.50/50
3	40	40	6	TO-39		2N4234	30	0.25/1	0.6	1.0/125
5	100	60	5	TO-39	BFX34		40	2.0/2	1.0	5.0/500
5	65	60	5	TO-39		BSS44	40	2.0/2	1.0	5.0/500
5	150	80	7	TO-39	2N4897		40	2.0/2	1.0	5.0/500
5	100	80	11.7	TO-39	2N5154	2N5153	70	2.50/5	0.7	2.50/250
5	100	100	6	TO-39	2N5338		20	5.0/2	1.2	5.0/500
5	100	100	6	TO-39	2N5339		40	5.0/2	1.2	5.0/500
7	130	60	10	TO-39	BU125		15	5.0/2	1.0	5.0/500
7	100	60	10	TO-39	BUY68		40	1.0/1	1.0	5.0/500
7	150	120	10	TO-39	BUY47		15	5.0/5	1.0	5.0/500
7	330	—	60	TO-220	BU407D		8	5.0/1	1.0	5.0/650
7	330	150	60	TO-220	BU407		10	5.0/1	1.0	5.0/500
7	200	170	10	TO-39	BUY48		15	5.0/5	1.0	5.0/500
7	400	—	60	TO-220	BU406D		8	5.0/1	1.0	5.0/650
7	400	200	60	TO-220	BU406		10	5.0/1	1.0	5.0/500
7	400	200	50	TO-3	BUY18S		20	1.0/5	1.0	5.0/500
* 8	330	150	60	TO-220	BU807		100	5.0/2	1.5	5.0/50
* 8	400	200	60	TO-220	BU806		100	5.0/2	1.5	5.0/50

* Darlington types.

SELECTION GUIDES BASED ON TECHNOLOGY AND PACKAGES

(continued)

MULTIEPITAXIAL PLANAR – I_{CM} 1 to 70A; V_{CEO} 75 to 450V

I_C range up to 70A
 Good h_{FE} linearity
 Very low leakage
 High switching speed
 High $E_{s/b}$ capability
 Total base-collector passivation

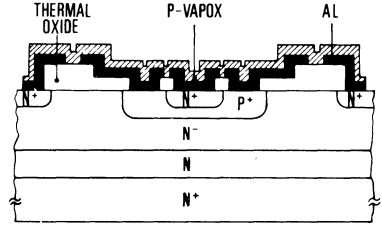

MULTIEPITAXIAL PLANAR

I_C (A)	V_{CBO} (V)	V_{CEO} (V)	P_{tot} (W)	Package	NPN	h_{FE} min	I_C/V_{CE} (A/V)	V_{CEsat} max (V)	I_C/I_B (A/mA)
1	350	250	40	TO-220	TIP47	10	1.0/10	1.0	1.0/200
1	400	300	40	TO-220	TIP48	10	1.0/10	1.0	1.0/200
1	450	350	40	TO-220	TIP49	10	1.0/10	1.0	1.0/200
1.5	700	400	40	TO-126	MJE13003	5	1.0/2	1.0	1.0/250
2.5	600	400	36	TO-126	BU801	100	1.0/3	2.2	1.0/15
* 6	400	350	60	TO-220	BU910	20	4.0/1.8	1.8	2.50/50
* 6	450	400	60	TO-220	BU911	20	4.0/1.8	1.8	2.50/50
* 6	500	450	60	TO-220	BU912	20	4.0/1.8	1.8	2.0/50
10	100	80	60	TO-3	BDY91	20	10.0/5	0.5	5.0/500
10	120	100	60	TO-3	BDY90	20	10.0/5	0.5	5.0/500
10	150	120	140	TO-3	2N6354	20	5.0/2	0.5	5.0/500
12	300	250	120	TO-3	BUX42	8	6.0/4	1.2	4.0/400
15	150	110	140	TO-3	2N6496	12	8.0/2	1.0	8.0/800
18	220	160	120	TO-3	BUX41N	8	12.0/4	1.2	8.0/800
15	250	200	120	TO-3	BUX41	8	8.0/4	1.2	5.0/500
20	120	75	140	TO-3	2N5039	20	10.0/5	1.0	10.0/1000
20	150	90	140	TO-3	2N5038	20	12.0/5	1.0	12.0/1200
20	160	125	120	TO-3	BUX40	8	15.0/4	1.2	10.0/1000
20	220	160	150	TO-3	BUX11N	10	15.0/4	0.6	8.0/800
20	250	200	150	TO-3	BUX11	10	12.0/4	0.6	6.0/600
20	300	250	150	TO-3	BUX12	10	10.0/4	1.0	5.0/500
25	120	80	175	TO-3	BDY57	20	10.0/4	1.4	10.0/1000
25	160	125	175	TO-3	BDY58	20	10.0/4	1.4	10.0/1000
25	160	125	150	TO-3	BUX10	10	20.0/4	0.6	10.0/1000

* Darlington types.

MULTIEPITAXIAL PLANAR (continued)

I_C (A)	V_{CBO} (V)	V_{CEO} (V)	P_{tot} (W)	Package	NPN	@		@	
						h_{FE} min	I_C/V_{CE} (A/V)	V_{CEsat} max (V)	I_C/I_B (A/mA)
30	120	90	140	TO-3	2N5671	20	20.0/5	0.75	15.0/1200
30	150	120	140	TO-3	2N5672	20	20.0/5	0.75	15.0/1200
40	150	120	140	TO-3	2N6033	10	40.0/2	1.0	40.0/4000
40	250	200	250	TO-3	BUV21	10	25.0/4	0.6	12.0/1200
40	250	200	350	TO-3	BUX21	10	25.0/4	0.6	12.0/1200
40	300	250	250	TO-3	BUV22	10	20.0/4	1.0	10.0/1000
40	300	250	350	TO-3	BUX22	10	20.0/4	1.0	10.0/1000
50	120	90	140	TO-3	2N6032	10	50.0/2.6	1.3	50.0/5000
50	160	125	250	TO-3	BUV20	10	50.0/4	0.6	25.0/2500
50	160	125	350	TO-3	BUX20	10	50.0/4	0.6	25.0/2500
60	300	200	350	TO-3	BUR51	15	50.0/4	1.0	30.0/2000
60	350	250	350	TO-3	BUR52	15	40.0/4	1.8	25.0/2000
70	200	125	350	TO-3	BUR50	15	50.0/4	1.0	35.0/2000

SELECTION GUIDES BASED ON TECHNOLOGY AND PACKAGES

(continued)

MULTIEPITAXIAL MESA – I_{CM} 4 to 30A; V_{CEO} 325 to 600V

NPN and PNP types
 High voltage (V_{CBO} up to 1000V)
 High power
 Very good $I_{s/b}$ and $E_{s/b}$ performance
 High switching speed
 High f_T (20 MHz)
 Good stability

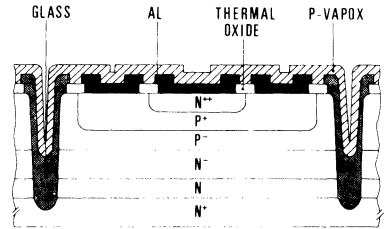

MULTIEPITAXIAL MESA

I_C (A)	V_{CBO} (V)	V_{CEO} (V)	P_{tot} (W)	Package	NPN	PNP	h_{FE} min	I_C/V_{CE} (A/V)	V_{CEsat} max(V)	I_C/I_B (A/mA)
4	700	400	75	TO-220	MJE13005		10	1.0/5	0.6	2.0/500
6	800	375	75	TO-3	BU326		25	1.00/5	1.5	2.50/500
6	800	375	113	SOT-93	BU426		25•	0.60/5	1.5	2.50/500
6	800	400	60°	TO-3	BU326S		3.5	4.0/5	1.5	2.50/500
6	900	400	75	TO-3	BU326A		25•	1.00/5	1.5	2.50/500
6	900	400	113	SOT-93	BU426A		25•	0.60/5	1.5	2.50/500
8	450	400	120	TO-3	BUX44		8	4.0/4	1.5	4.0/800
8	700	400	80	TO-220	MJE13007		8	2.0/5	1.5	5.0/1000
8	850	400	125	TO-3	2N6545		4	8.0/5	1.5	5.0/1000
8.5	850	400	107	TO-3	BUX47		3	9.0/3	1.5	6.0/1200
10	400	325	120	TO-3	BUX43		8	5.0/4	2.0	5.0/1000
10	800	325	100	TO-3	BUY69B		15	2.50/10	3.3	8.0/2500
10	500	400	125	TO-3	BUW34	BUW32	15	1.0/5	1.5	5.0/1000
10	800	400	125	TO-3	BUW35		15	1.0/5	1.5	5.0/1000
10	450	400	150	TO-3	BUX14		8	6.0/4	1.6	6.0/1200
10	800	400	100	TO-3	BUX80		5	5.0/1.5	1.5	5.0/1000
10	1000	400	100	TO-3	BUY69A		15	2.50/10	3.3	8.0/2500
10	900	450	125	TO-3	BUW36		15	1.0/5	1.5	5.0/1000
15	400	325	150	TO-3	BUX13		8	8.0/4	1.5	8.0/1600
15	400	350	150	TO-3	BU930		40	10.0/1.8	1.8	8.0/100
15	450	400	150	TO-3	BU931		40	10.0/1.8	1.8	8.0/100
15	500	400	175	TO-3	BUW44		6	6.0/1.5	3.0	10.0/2000
15	800	400	175	TO-3	BUW45		7	7.0/1.5	1.5	10.0/2000
15	850/450	400	175	TO-3	BUX48	BUW42	5	15.0/3	1.5	10.0/2000
15	850	400	175	TO-3	2N6547		5	15.0/5	1.5	10.0/2000
15	500	450	150	TO-3	BU932		40	10.0/1.8	1.8	8.0/150
15	900	450	175	TO-3	BUW46		7	7.0/1.5	1.5	10.0/2000
15	1000	450	175	TO-3	BUX48A		5	12.0/3	1.5	8.0/1600
15	500	500	350	TO-3	BUX25		8	8.0/4	1.0	8.0/1600
15	1000	600	175	TO-3	BUX48B		15	1.0/10	2.0	8.0/2500
20	450	400	350	TO-3	BUX24		8	12.0/4	1.0	12.0/2400
30	400	325	250	TO-3	BUV23		8	16.0/4	1.0	16.0/3200
30	400	325	350	TO-3	BUX23		8	16.0/4	1.0	16.0/3200
20	450	400	250	TO-3	BUV24		8	12.0/4	1.0	12.0/2400

* Darlington types, Multiepitaxial planar

• Typical.

° $T_C = 75^\circ\text{C}$.

Recent product introductions

EPITAXIAL BASE

I_C (A)	V_{CBO} (V)	V_{CEO} (V)	P_{tot} (W)	Package	NPN	PNP	@		@	
							h_{FE} min.	I_C/V_{CE} (A/V)	V_{CEsat} max. (V)	I_C/I_B (A/mA)
* 12	60	60	125	SOT-93	BDV65	BDV64	1000	5.0/4	2.0	5.0/20
* 12	80	80	125	SOT-93	BDV65A	BDV64A	1000	5.0/4	2.0	5.0/20
* 12	100	100	125	SOT-93	BDV65B	BDV64B	1000	5.0/4	2.0	5.0/20
* 16	60	60	150	TO-3	MJ4030	MJ4033	1000	10/3	4.0	16/80
* 16	80	80	150	TO-3	MJ4031	MJ4034	1000	10/3	4.0	16/80
* 16	100	100	150	TO-3	MJ4032	MJ4035	1000	10/3	4.0	16/80
* 30	60	60	200	TO-3	MJ11012	MJ11011	200	30/5	4.0	30/300
* 30	90	90	200	TO-3	MJ11014	MJ11013	200	30/5	4.0	30/300
* 30	120	120	200	TO-3	MJ11016	MJ11015	200	30/5	4.0	30/300
* 10	60	60	125	SOT-93	TIP140	TIP145	500	10/4	3.0	10/40
* 10	80	80	125	SOT-93	TIP141	TIP146	500	10/4	3.0	10/40
* 10	100	100	125	SOT-93	TIP142	TIP147	500	10/4	3.0	10/40
20	60	60	160	TO-3	2N6285	2N6282	750	10/3	3.0	20/200
20	80	80	160	TO-3	2N6286	2N6283	750	10/3	3.0	20/200
20	100	100	160	TO-3	2N6287	2N6284	750	10/3	3.0	20/200

* Darlington types

MULTIEPITAXIAL PLANAR

I_C (A)	V_{CBO} (V)	V_{CEO} (V)	P_{tot} (W)	Package	NPN	@		@	
						h_{FE} min.	I_C/V_{CE} (A/V)	V_{CEsat} max. (V)	I_C/I_B (A/mA)
* 7	600	400	75	TO-220	BU810	10	7.0/3	2.0	2.0/20
* 28	600	400	175	TO-3	BUT13	30	10/5	5.0	28/5600
* 28	600	400	150	SOT-93	BUT13P	30	10/5	5.0	28/5600
3	250	200	15	TO-126	BUY49P	40	0.5/5	0.2	0.5/50
* 20	400	350	175	TO-3	MJ10004	50	5.0/5	1.9	10/400
* 20	450	400	175	TO-3	MJ10005	50	5.0/5	1.9	10/400
* 20	400	350	150	SOT-93	MJ10004P	50	5.0/5	1.9	10/400
* 20	450	400	150	SOT-93	MJ10005P	50	5.0/5	1.9	10/400

* Darlington types

SELECTION GUIDES BASED ON TECHNOLOGY AND PACKAGES

(continued)

MULTIEPITAXIAL PLANAR (continued)

I_C (A)	V_{CBO} (V)	V_{CEO} (V)	P_{tot} (W)	Package	NPN	h_{FE} (min.)	@ I_C/V_{CE} (A/V)	V_{CEsat} max (V)	@ I_C/I_B (A/MA)
* 10	400	350	105	SOT-93	BU920P	50	7.0/1.8	1.8	5/50
* 10	450	400	105	SOT-93	BU921P	50	7.0/1.8	1.8	5/50
* 10	500	450	105	SOT-93	BU922P	50	7.0/1.8	1.8	5/50
4	40	30	30	TO-220	D44C1	25	1.0/1	0.5	1/100
4	55	45	30	TO-220	D44C4	25	1.0/1	0.5	1/100
4	70	60	30	TO-220	D44C7	25	1.0/1	0.5	1/100
4	90	80	30	TO-220	D44C10	25	1.0/1	0.5	1/100
10	—	30	50	TO-220	D44H1	20	4.0/1	1.0	8/800
10	—	45	50	TO-220	D44H4	20	4.0/1	1.0	8/800
10	—	60	50	TO-220	D44H7	20	4.0/1	1.0	8/800
10	—	80	50	TO-220	D44H10	20	4.0/1	1.0	8/800
4	200	125	31.25	TO-220	D44Q1	20	2.0/10	1.0	2/200
4	250	175	31.25	TO-220	D44Q3	20	2.0/10	1.0	2/200
4	300	225	31.25	TO-220	D44Q5	20	2.0/10	1.0	2/200
1	500	400	40	TO-220	TIP50	10	1.0/10	1.0	1/200
* 15	400	350	105	SOT-93	BU930P	40	10/1.8	1.8	8/100
* 15	450	400	105	SOT-93	BU931P	40	10/1.8	1.8	8/100
* 15	500	450	105	SOT-93	BU932P	53	8.0/1.8	1.8	8/150
7	140	90	50	TO-220	2N6702	20	5.0/2	1.5	7/700

* Darlington types

MULTIEPITAXIAL MESA

I_C (A)	V_{CBO} (V)	V_{CEO} (V)	P_{tot} (W)	Package	NPN	h_{FE} (min.)	@ I_C/V_{CE} (A/V)	V_{CEsat} max. (V)	@ I_C/I_B (A/MA)
5	850	400	850	TO-220	BUV46	5.0	3.5/5	1.5	2.5/500
9	850	400	120	SOT-93	BUV47	3.0	8.0/3	1.5	5.0/1000
9	1000	450	120	SOT-93	BUV47A	3.0	8.0/3	1.5	5.0/1000
5	850	400	100	SOT-93	BUW11	5.0	3.0/1.5	1.5	3.0/600
8	850	400	125	SOT-93	BUW12	5.0	6.0/1.5	1.5	6.0/1200
8	1000	450	125	SOT-93	BUW12A	5.0	6.0/1.5	1.5	6.0/1200
15	1000	700	175	TO-3	BUX48C	2.5	10/3	1.5	6.0/1500
2	800	400	40	TO-220	BUX84	50(°)	0.1/5	1.1	1.0/200
15	850	400	150	SOT-93	BUV48	5.0	15/5	1.5	10/2000
15	1000	450	150	SOT-93	BUV48A	5.0	12/5	1.5	8.0/1600
50	160	125	250	TO-3	BUV20	10	50/4	1.2	50/5000
40	250	200	250	TO-3	BUV21	10	25/4	1.5	25/3000
40	300	250	250	TO-3	BUV22	10	20/4	1.5	20/2500
30	400	325	250	TO-3	BUV23	8.0	16/4	1.0	16/3200
20	450	400	250	TO-3	BUV24	8.0	12/4	1.0	12/2400
15	500	500	250	TO-3	BUV25	8.0	8.0/4	1.0	8.0/1600
3	350	250	100	SOT-93	TIP51	10	3.0/10	1.5	3.0/600
3	400	300	100	SOT-93	TIP52	10	3.0/10	1.5	3.0/600
3	450	350	100	SOT-93	TIP53	10	3.0/10	1.5	3.0/600
3	500	400	100	SOT-93	TIP54	10	3.0/10	1.5	3.0/600

(°) Typical

CROSS REFERENCE GUIDE

TYPE	SGS-ATES NEAREST	PAGE	TYPE	SGS-ATES NEAREST	PAGE	TYPE	SGS-ATES NEAREST	PAGE
BD 135	BD 135	*	BD 205	BD 905	120	BD 243	BD 243	74
BD 136	BD 136	*	BD 206	BD 906	124	BD 243A	BD 243A	74
BD 137	BD 137	*	BD 207	BD 907	120	BD 243B	BD 243B	74
BD 138	BD 138	*	BD 208	BD 908	124	BD 243C	BD 243C	74
BD 139	BD 139	*	BD 220	BD 537	94	BD 244	BD 244	76
BD 140	BD 140	*	BD 221	BD 533	94	BD 244A	BD 244A	76
BD 165	BD 437	78	BD 222	BD 535	94	BD 244B	BD 244B	76
BD 166	BD 438	82	BD 223	BD 538	98	BD 244C	BD 244C	76
BD 167	BD 439	86	BD 224	BD 534	98	BD 245	BD 705	110
BD 168	BD 440	90	BD 225	BD 536	98	BD 245A	BD 707	110
BD 169	BD 441	86	BD 226	BD 375	*	BD 245B	BD 709	110
BD 170	BD 442	90	BD 227	BD 376	*	BD 245C	BD 711	110
BD 175	BD 175	48	BD 228	BD 377	*	BD 246	BD 706	115
BD 176	BD 176	52	BD 229	BD 378	*	BD 246A	BD 708	115
BD 177	BD 177	48	BD 230	BD 379	*	BD 246B	BD 710	115
BD 178	BD 178	52	BD 231	BD 380	*	BD 246C	BD 712	115
BD 179	BD 179	48	BD 233	BD 233	56	BD 253	BUW 24	*
BD 180	BD 180	52	BD 234	BD 234	60	BD 253A	BUW 25	*
BD 181	BD 181	*	BD 235	BD 235	56	BD 253B	BU 136	*
BD 182	BD 182	*	BD 236	BD 236	60	BD 253C	BU 326A	240
BD 183	BD 183	*	BD 238	BD 238	60	BD 262	BD 678	106
BD 185	BD 435	78	BD 239	BD 239	64	BD 262A	BD 680	106
BD 186	BD 436	82	BD 239A	BD 239A	64	BD 262B	BD 682	106
BD 187	BD 437	78	BD 239B	BD 239B	64	BD 263	BD 677	102
BD 188	BD 438	82	BD 239C	BC 239C	64	BD 263A	BD 679	102
BD 189	BD 439	86	BD 240	BD 240	66	BD 263B	BD 681	102
BD 190	BD 440	90	BD 240A	BD 240A	66	BD 264	BDW 24A	*
BD 195	BD 533	94	BD 240B	BD 240B	66	BD 264A	BDW 24B	*
BD 196	BD 534	98	BD 240C	BD 240C	66	BD 265	BDW 23A	*
BD 197	BD 535	94	BD 241	BD 241	70	BD 265A	BDW 23B	*
BD 198	BD 536	98	BD 241A	BD 241A	70	BD 266	BDX 54A	173
BD 199	BD 537	94	BD 241B	BD 241B	70	BD 266A	BDX 54B	173
BD 200	BD 538	98	BD 241C	BD 241C	70	BD 266B	BDX 54C	173
BD 201	BD 705	110	BD 242	BD 242	72	BD 267	BDX 53A	161
BD 202	BD 706	115	BD 242A	BD 242A	72	BD 267A	BDX 53B	161
BD 203	BD 707	110	BD 242B	BD 242B	72	BD 267B	BDX 53C	161
BD 204	BD 708	115	BD 242C	BD 242C	72	BD 268	BDW 94A	156

* Data sheet available on request

CROSS REFERENCE GUIDE (continued)

TYPE	SGS-ATES NEAREST	PAGE	TYPE	SGS-ATES NEAREST	PAGE	TYPE	SGS-ATES NEAREST	PAGE
BD 268A	BDW 94B	156	BD 435	BD 435	78	BD 586	BD 534	98
BD 269	BDW 93A	151	BD 436	BD 436	82	BD 587	BD 535	94
BD 269A	BDW 93B	151	BD 437	BD 437	78	BD 588	BD 536	98
BD 271	BD 533	94	BD 438	BD 438	82	BD 589	BD 537	94
BD 272	BD 534	98	BD 439	BD 439	86	BD 590	BD 538	98
BD 273	BD 535	94	BD 440	BD 440	90	BD 595	BD 705	110
BD 274	BD 536	98	BD 441	BD 441	86	BD 596	BD 706	115
BD 275	BD 537	94	BD 442	BD 442	90	BD 597	BD 707	110
BD 276	BD 538	98	BD 533	BD 533	94	BD 598	BD 708	115
BD 277	BD 664	*	BD 534	BD 534	98	BD 599	BD 709	110
BD 278	BD 663	*	BD 535	BD 535	94	BD 600	BD 710	115
BD 301	BD 533	94	BD 536	BD 536	98	BD 601	BD 711	110
BD 302	BD 534	98	BD 537	BD 537	94	BD 602	BD 712	115
BD 303	BD 535	94	BD 538	BD 538	98	BD 605	BD 905	120
BD 304	BD 536	98	BD 539	BD 241	70	BD 606	BD 906	124
BD 311	BDW 51A	133	BD 539A	BD 241A	70	BD 607	BD 907	120
BD 312	BDW 52A	138	BD 539B	BD 241B	70	BD 608	BD 908	124
BD 313	BDW 51B	133	BD 539C	BD 241C	70	BD 609	BD 909	120
BD 314	BDW 52B	138	BD 540	BD 242	72	BD 610	BD 910	124
BD 331	BDX 53A	161	BD 540A	BD 242A	72	BD 633	BD 533	94
BD 332	BDX 54A	173	BD 540B	BD 242B	72	BD 634	BD 534	98
BD 333	BDX 53B	161	BD 540C	BD 242C	72	BD 635	BD 535	94
BD 334	BDX 54B	173	BD 543	BD 905	120	BD 636	BD 536	98
BD 335	BDX 53C	161	BD 543A	BD 907	120	BD 637	BD 537	94
BD 336	BDX 54C	173	BD 543B	BD 909	120	BD 638	BD 538	98
BD 361	BD 433	78	BD 544	BD 906	124	BD 643	BDX 53	161
BD 361A	BD 433	78	BD 544A	BD 908	124	BD 644	BDX 54	173
BD 362	BD 434	82	BD 544B	BD 910	124	BD 645	BDX 53A	161
BD 362A	BD 434	82	BD 561	BD 437	78	BD 646	BDX 54A	173
BD 375	BD 375	*	BD 562	BD 438	82	BD 647	BDX 53B	161
BD 376	BD 376	*	BD 575	BD 533	94	BD 648	BDX 54B	173
BD 377	BD 377	*	BD 576	BD 534	98	BD 649	BDX 53C	161
BD 378	BD 378	*	BD 577	BD 535	94	BD 650	BDX 54C	173
BD 379	BD 379	*	BD 578	BD 536	98	BD 663	BD 663	*
BD 380	BD 380	*	BD 579	BD 537	94	BD 664	BD 664	*
BD 433	BD 433	78	BD 580	BD 538	98	BD 675A	BD 675A	102
BD 434	BD 434	82	BD 585	BD 533	94	BD 676A	BD 676A	106

* Data sheet available on request

TYPE	SGS-ATES NEAREST	PAGE	TYPE	SGS-ATES NEAREST	PAGE	TYPE	SGS-ATES NEAREST	PAGE
BD 677	BD 677	102	BD 796	BD 706	115	BD 943	BD 533	94
BD 677A	BD 677A	102	BD 797	BD 707	110	BD 944	BD 534	98
BD 678	BD 678	106	BD 798	BD 708	115	BD 945	BD 535	94
BD 678A	BD 678A	106	BD 799	BD 709	110	BD 946	BD 534	98
BD 679	BD 679	102	BD 800	BD 710	115	BD 947	BD 533	94
BD 679A	BD 679A	102	BD 801	BD 711	110	BD 948	BD 534	98
BD 680	BD 680	106	BD 802	BD 712	115	BD 949	BD 241A	70
BD 680A	BD 680A	106	BD 805	BD 905	120	BD 950	BD 242A	72
BD 681	BD 681	102	BD 806	BD 906	124	BD 951	BD 241B	70
BD 682	BD 682	106	BD 807	BD 907	120	BD 952	BD 242B	72
BD 695A	BDX 53	161	BD 808	BD 908	124	BD 953	BD 241C	70
BD 696A	BDX 54	173	BD 809	BD 909	120	BD 954	BD 242C	72
BD 697	BDX 53A	161	BD 810	BD 910	124	BDT 62	BDW 94A	156
BD 697A	BDX 53A	161	BD 895	BDW 93	151	BDT 62A	BDW 94B	156
BD 698	BDX 54A	173	BD 896	BDW 94	156	BDT 62B	BDW 94C	156
BD 698A	BDX 54A	173	BD 897	BDW 93A	151	BDT 63	BDW 93A	151
BD 699	BDX 53B	161	BD 898	BDW 94A	151	BDT 63A	BDW 93B	151
BD 699A	BDX 53B	161	BD 899	BDW 93B	151	BDT 63B	BDW 93C	151
BD 700	BDX 54B	173	BD 900	BDW 94B	156	BDT 91	BD 907	120
BD 700A	BDX 54B	173	BD 901	BDW 93C	151	BDT 92	BD 908	124
BD 701	BDX 53C	161	BD 902	BDW 94C	156	BDT 93	BD 909	120
BD 702	BDX 54C	173	BD 905	BD 905	120	BDT 94	BD 910	124
BD 705	BD 705	110	BD 906	BD 906	124	BDT 95	BD 911	120
BD 706	BD 706	115	BD 907	BD 907	120	BDT 96	BD 912	124
BD 707	BD 707	110	BD 908	BD 908	124	BDV 64	BDV 64	128
BD 708	BD 708	115	BD 909	BD 909	120	BDV 64A	BDV 64A	128
BD 709	BD 709	110	BD 910	BD 910	124	BDV 64B	BDV 64B	128
BD 710	BD 710	115	BD 911	BD 911	120	BDV 65	BDV 65	128
BD 711	BD 711	110	BD 912	BD 912	124	BDV 65A	BDV 65A	128
BD 712	BD 712	115	BD 933	BD 239	64	BDV 65B	BDV 65B	128
BD 733	BD 533	94	BD 934	BD 240	66	BDW 21	BDW 21	*
BD 734	BD 534	98	BD 935	BD 239A	64	BDW 21A	BDW 21A	*
BD 735	BD 533	94	BD 936	BD 240A	66	BDW 21B	BDW 21B	*
BD 736	BD 534	98	BD 937	BD 239B	64	BDW 21C	BDW 21C	*
BD 737	BD 533	94	BD 938	BD 240B	66	BDW 22	BDW 22	*
BD 738	BD 534	98	BD 939	BD 239C	64	BDW 22A	BDW 22A	*
BD 795	BD 705	110	BD 940	BD 240C	66	BDW 22B	BDW 22B	*

* Data sheet available on request

CROSS REFERENCE GUIDE (continued)

TYPE	SGS-ATES NEAREST	PAGE	TYPE	SGS-ATES NEAREST	PAGE	TYPE	SGS-ATES NEAREST	PAGE
BDW 22C	BDW 22C	*	BDW 74	BDW 94	156	BDX 64A	BDX 88B	200
BDW 23	BDW 23	*	BDW 74A	BDW 94A	156	BDX 64B	BDX 88C	200
BDW 23A	BDW 23A	*	BDW 74B	BDW 94B	156	BDX 65	BDX 87A	195
BDW 23B	BDW 23B	*	BDW 74C	BDW 74C	156	BDX 65A	BDX 87B	195
BDW 23C	BDW 23C	*	BDW 91	BDW 91	143	BDX 65B	BDX 87C	195
BDW 24	BDW 24	*	BDW 92	BDW 92	147	BDX 70	BDX 71	*
BDW 24A	BDW 24A	*	BDW 93	BDW 93	151	BDX 77	BD 709	110
BDW 24B	BDW 24B	*	BDW 93A	BDW 93A	151	BDX 78	BD 710	115
BDW 24C	BDW 24C	*	BDW 93B	BDW 93B	151	BDX 83	BDX 87	195
BDW 51	BDW 51	133	BDW 93C	BDW 93C	151	BDX 83A	BDX 87A	195
BDW 51A	BDW 51A	133	BDW 94	BDW 94	156	BDX 83B	BDX 87B	195
BDW 51B	BDW 51B	133	BDW 94A	BDW 94A	156	BDX 83C	BDX 87C	195
BDW 51C	BDW 51C	133	BDW 94B	BDW 94B	156	BDX 84	BDX 88	200
BDW 52	BDW 52	138	BDW 94C	BDW 94C	156	BDX 84A	BDX 88A	200
BDW 52A	BDW 52A	138	BDX 33	BDX 53	161	BDX 84B	BDX 88B	200
BDW 52B	BDW 52B	138	BDX 33A	BDX 53A	161	BDX 84C	BDX 88C	200
BDW 52C	BDW 52C	138	BDX 33B	BDX 53B	161	BDX 85	BDX 85	185
BDW 53	BDW 23	*	BDX 33C	BDX 53C	161	BDX 85A	BDX 85A	185
BDW 53A	BDW 23A	*	BDX 34	BDX 54	173	BDX 85B	BDX 85B	185
BDW 53B	BDW 23B	*	BDX 34A	BDX 54A	173	BDX 85C	BDX 85C	185
BDW 53C	BDW 23C	*	BDX 34B	BDX 54B	173	BDX 86	BDX 86	190
BDW 54	BDW 24	*	BDX 34C	BDX 54C	173	BDX 86A	BDX 86A	190
BDW 54A	BDW 24A	*	BDX 53	BDX 53	161	BDX 86B	BDX 86B	190
BDW 54B	BDW 24B	*	BDX 53A	BDX 53A	161	BDX 86C	BDX 86C	190
BDW 54C	BDW 24C	*	BDX 53B	BDX 53B	161	BDX 87	BDX 87	195
BDW 63	BDX 53	161	BDX 53C	BDX 53C	161	BDX 87A	BDX 87A	195
BDW 63A	BDX 53A	161	BDX 54	BDX 54	173	BDX 87B	BDX 87B	195
BDW 63B	BDX 53B	161	BDX 54A	BDX 54A	173	BDX 87C	BDX 87C	195
BDW 63C	BDX 53C	161	BDX 54B	BDX 54B	173	BDX 88	BDX 88	200
BDW 64	BDX 54	173	BDX 54C	BDX 54C	173	BDX 88A	BDX 88A	200
BDW 64A	BDX 54A	173	BDX 62	BDX 86A	190	BDX 88B	BDX 88B	200
BDW 64B	BDX 54B	173	BDX 62A	BDX 86B	190	BDX 88C	BDX 88C	200
BDW 64C	BDX 54C	173	BDX 62B	BDX 86C	190	BDX 91	BDW 21A	*
BDW 73	BDW 93	151	BDX 63	BDX 85A	185	BDX 92	BDW 21A	*
BDW 73A	BDW 93A	151	BDX 63A	BDX 85B	185	BDX 93	BDW 21B	*
BDW 73B	BDW 93B	151	BDX 63B	BDX 85C	185	BDX 94	BDW 22B	*
BDW 73C	BDW 93C	151	BDX 64	BDX 88A	200	BDX 95	BDW 21C	*

* Data sheet available on request

TYPE	SGS-ATES NEAREST	PAGE	TYPE	SGS-ATES NEAREST	PAGE	TYPE	SGS-ATES NEAREST	PAGE
BDX 96	BDW 22C	*	BU 361	BUW 35	359	BUR 21	BUV 21	335
BDY 57	BDY 57	205	BU 406	BU 406	249	BUR 22	BUV 22	335
BDY 58	BDY 58	205	BU 406D	BU 406D	255	BUR 23	BUV 23	338
BDY 90	BDY 90	208	BU 406H	BU 406H	249	BUR 24	BUV 24	338
BDY 91	BDY 91	208	BU 407	BU 407	261	BUR 50	BUR 50	301
BDY 92	BDY 92	208	BU 407D	BU 407D	255	BUR 51	BUR 51	307
BFX 34	BFX 34	210	BU 407H	BU 407H	261	BUR 53	BUR 52	313
BSS 44	BSS 44	214	BU 408	BU 408	249	BUS 12	BUW 35	359
BSW 67	BSW 67	218	BU 408D	BU 408D	255	BUW 12A	BUW 36	359
BSW 68	BSW 68	218	BU 411	BU 607D	*	BUS 13	BUX 48	449
BU 104	BU 606	*	BU 412	BU 607D	*	BUS 13A	BUW 46	366
BU 104D	BU 606D	*	BU 426	BU 426	267	BUT 13	BUT 13	319
BU 104DP	BU 406D	255	BU 426A	BU 426A	267	BUT 13P	BUT 13P	327
BU 106	BU 607	*	BU 606	BU 606	*	BUV 20	BUV 20	335
BU 107	BU 607	*	BU 606D	BU 606D	*	BUV 21	BUV 21	335
BU 109	BU 607	*	BU 607	BU 607	*	BUV 22	BUV 22	335
BU 109D	BU 607D	*	BU 607D	BU 607D	*	BUV 23	BUV 23	338
BU 109DP	BU 407D	255	BU 608	BU 608	*	BUV 24	BUV 24	338
BU 110	BU 607	*	BU 608D	BU 608D	*	BUV 25	BUV 25	338
BU 111	BUW 24	*	BU 807	BU 807	275	BUV 46	BUV 46	341
BU 125	BU 125	222	BU 810	BU 810	281	BUV 47	BUV 47	343
BU 125S	BUS 125S	226	BU 910	BU 910	285	BUV 47A	BUV 47A	343
BU 126	BU 126	*	BU 911	BU 911	285	BUV 48	BUV 48	346
BU 129	BU 606	*	BU 912	BU 912	285	BUV 48A	BUV 48A	346
BU 133	BU 126	*	BU 920	BU 920	*	BUW 11	BUW 11	348
BU 134	BUW 25	*	BU 920P	BU 920P	290	BUW 12	BUW 12	351
BU 137	BUY 69A	484	BU 921	BU 921	*	BUW 12A	BUW 12A	351
BU 310	BU 607	*	BU 921P	BU 921P	290	BUW 24	BUW 24	*
BU 311	BU 607	*	BU 922	BU 922	*	BUW 25	BUW 25	*
BU 312	BU 607	*	BU 922P	BU 922P	290	BUW 26	BUW 26	*
BU 322	BU 920	*	BU 930	BU 930	293	BUW 32	BUW 32	354
BU 322A	BU 922	*	BU 930P	BU 930P	299	BUW 34	BUW 34	359
BU 323	BU 930	293	BU 931	BU 931	293	BUW 35	BUW 35	359
BU 323A	BU 932	293	BU 931P	BU 931P	299	BUW 36	BUW 36	359
BU 326	BU 326S	245	BU 932	BU 932	293	BUW 42	BUW 42	364
BU 326A	BU 326A	240	BU 932P	BU 932P	299	BUW 44	BUW 44	366
BU 326S	BU 326S	245	BUR 20	BUV 20	335	BUW 45	BUW 45	366

* Data sheet available on request

CROSS REFERENCE GUIDE (continued)

TYPE	SGS-ATES NEAREST	PAGE	TYPE	SGS-ATES NEAREST	PAGE	TYPE	SGS-ATES NEAREST	PAGE
BUW 46	BUW 46	366	BUX 37	BU 931	293	D44 C2	D44 C2	487
BUW 57	BUX 10	371	BUX 40	BUX 40	417	D44 C3	D44 C3	487
BUW 58	BUX 11N	383	BUX 40A	BUX 40	417	D44 C4	D44 C4	487
BUW 66	BUW 66	*	BUX 40S	BUX 40	417	D44 C5	D44 C5	487
BUW 67	BUW 67	*	BUX 41	BUX 41	423	D44 C6	D44 C6	487
BUW 73	BUX 11	377	BUX 41N	BUX 41N	429	D44 C7	D44 C7	487
BUX 10	BUX 10	371	BUX 41S	BUX 41	423	D44 C8	D44 C8	487
BUX 10S	BUX 10	371	BUX 42	BUX 42	435	D44 C9	D44 C9	487
BUX 11	BUX 11	377	BUX 43	BUX 43	441	D44 C10	D44 C10	487
BUX 11N	BUX 11N	383	BUX 44	BUX 44	443	D44 C11	D44 C11	487
BUX 11S	BUX 11	377	BUX 45	BUW 34	359	D44 C12	D44 C12	487
BUX 12	BUX 12	389	BUX 46	BUX 46	445	D44 H1	D44 H1	489
BUX 13	BUX 13	395	BUX 47	BUX 47	447	D44 H2	D44 H2	489
BUX 14	BUX 14	397	BUX 48	BUX 48	449	D44 H4	D44 H4	489
BUX 15	BUW 44	366	BUX 48A	BUX 48A	449	D44 H5	D44 H5	489
BUX 16	BUW 24	*	BUX 48B	BUX 48B	449	D44 H7	D44 H7	489
BUX 16A	BUW 24	*	BUX 48C	BUX 48C	449	D44 H8	D44 H8	489
BUX 16B	BUW 24	*	BUX 77	BUX 77	*	D44 H10	D44 H10	489
BUX 16C	BUW 24	*	BUX 78	BUX 78	*	D44 H11	D44 H11	489
BUX 17	BUX 41N	429	BUX 80	BUX 80	*	D44 Q1	D44 Q1	491
BUX 17A	BUX 42	435	BUX 82	BUX 82	*	D44 Q3	D44 Q3	491
BUX 17B	BUW 44	366	BUX 84	BUX 84	*	D44 Q5	D44 Q5	491
BUX 17C	BUW 44	366	BUX 97	BUX 97	*	MJ 424	BUW 35	359
BUX 18	BUX 41	423	BUX 97A	BUX 97A	*	MJ 425	BUW 35	359
BUX 18A	BUX 42	435	BUX 97B	BUX 97B	*	MJ 900	MJ 900	493
BUX 18B	BUW 35	359	BUY 18S	BUY 18S	466	MJ 901	MJ 901	493
BUX 18C	BUW 35	359	BUY 47	BUY 47	469	MJ 1000	MJ 1000	493
BUX 20	BUX 20	399	BUY 48	BUY 48	469	MJ 1001	MJ 1001	493
BUX 20S	BUX 20	399	BUY 49P	BUY 49P	474	MJ 2500	MJ 2500	495
BUX 21	BUX 21	405	BUY 49S	BUY 49S	476	MJ 2501	MJ 2501	495
BUX 21S	BUX 21	405	BUY 57	BUX 40	417	MJ 2955	MJ 2955	497
BUX 22	BUX 22	411	BUY 58	BUX 41N	429	MJ 3000	MJ 3000	495
BUX 23	BUY 23	338	BUY 68	BUY 68	480	MJ 3001	MJ 3001	495
BUX 24	BUY 24	338	BUY 69A	BUY 69A	484	MJ 3029	BUW 24	*
BUX 25	BUY 25	338	BUY 69B	BUY 69B	484	MJ 3030	BUW 25	*
BUX 28	BU 920	*	BUY 69C	BUY 69C	484	MJ 3040	BU 920P	290
BUX 29	BU 921	*	D44 C1	D44 C1	487	MJ 3041	BU 920P	290

* Data sheet available on request

TYPE	SGS-ATES NEAREST	PAGE	TYPE	SGS-ATES NEAREST	PAGE	TYPE	SGS-ATES NEAREST	PAGE
MJ 3042	BU 920P	290	MJE 801	MJE 801	508	TIP 32C	TIP 32C	530
MJ 4030	MJ 4030	499	MJE 802	MJE 802	508	TIP 41	TIP 41	532
MJ 4031	MJ 4031	499	MJE 803	MJE 803	508	TIP 41A	TIP 41A	532
MJ 4032	MJ 4032	499	MJE 13002	MJE 13002	511	TIP 41B	TIP 41B	532
MJ 4033	MJ 4033	499	MJE 13003	MJE 13003	511	TIP 41C	TIP 41C	532
MJ 4034	MJ 4034	499	MJE 13004	MJE 13004	517	TIP 42	TIP 42	534
MJ 4035	MJ 4035	499	MJE 13005	MJE 13005	517	TIP 42A	TIP 42A	534
MJ 10000	BU 930	293	MJE 13006	MJE 13006	522	TIP 42B	TIP 42B	534
MJ 10001	BU 931	293	MJE 13007	MJE 13007	522	TIP 42C	TIP 42C	534
MJ 10002	BU 920P	290	MJE 13007A	MJE 13007A	522	TIP 47	TIP 47	536
MJ 10003	BU 921P	290	SE 9300	BDW 93A	151	TIP 48	TIP 48	536
MJ 10004	MJ 10004	501	SE 9301	BDW 93B	151	TIP 49	TIP 49	536
MJ 10004P	MJ 10004P	501	SE 9302	BDW 93C	151	TIP 50	TIP 50	536
MJ 10005	MJ 10005	501	SE 9303	BDX 87A	195	TIP 51	TIP 51	542
MJ 10005P	MJ 10005P	501	SE 9304	BDX 87B	195	TIP 52	TIP 52	542
MJ 11011	MJ 11011	504	SE 9305	BDX 87C	195	TIP 53	TIP 53	542
MJ 11012	MJ 11012	504	SE 9400	BDW 94A	156	TIP 54	TIP 54	542
MJ 11013	MJ 11013	504	SE 9401	BDW 94B	156	TIP 73	BD 905	120
MJ 11014	MJ 11014	504	SE 9402	BDW 94C	156	TIP 73A	BD 907	120
MJ 11015	MJ 11015	504	SE 9403	BDX 88A	200	TIP 73B	BD 909	120
MJ 11016	MJ 11016	504	SE 9404	BDX 88B	200	TIP 73C	BD 911	120
MJ 10012	BU 931	293	SE 9405	BDX 88C	200	TIP 74	BD 906	124
MJ 13014	BUW 34	359	TIP 29	TIP 29	524	TIP 74A	BD 908	124
MJ 13015	BUW 34	359	TIP 29A	TIP 29A	524	TIP 74B	BD 910	124
MJ 13330	BUX 41	423	TIP 29B	TIP 29B	524	TIP 74C	BD 912	124
MJ 13331	BUX 42	435	TIP 29C	TIP 29C	524	TIP 100	BDX 53A	161
MJ 13332	BUV 23	338	TIP 30	TIP 30	526	TIP 101	BDX 53B	161
MJ 13333	BUV 24	338	TIP 30A	TIP 30A	526	TIP 102	BDX 53C	161
MJ 13334	BUV 24	338	TIP 30B	TIP 30B	526	TIP 105	BDX 54A	173
MJE 340	MJE 340	506	TIP 30C	TIP 30C	526	TIP 106	BDX 54B	173
MJE 350	MJE 350	506	TIP 31	TIP 31	528	TIP 107	BDX 54C	173
MJE 700	MJE 700	508	TIP 31A	TIP 31A	528	TIP 110	TIP 110	549
MJE 701	MJE 701	508	TIP 31B	TIP 31B	528	TIP 111	TIP 111	549
MJE 702	MJE 702	508	TIP 31C	TIP 31C	528	TIP 112	TIP 112	549
MJE 703	MJE 703	508	TIP 32	TIP 32	530	TIP 115	TIP 115	551
MJE 800	MJE 800	508	TIP 32A	TIP 32A	530	TIP 116	TIP 116	551
			TIP 32B	TIP 32B	530	TIP 117	TIP 117	551

CROSS REFERENCE GUIDE (continued)

TYPE	SGS-ATES NEAREST	PAGE	TYPE	SGS-ATES NEAREST	PAGE	TYPE	SGS-ATES NEAREST	PAGE
TIP 120	TIP 120	553	2N 3715	2N 3715	580	2N 5490	BD 705	110
TIP 121	TIP 121	553	2N 3716	2N 3716	580	2N 5492	BD 707	110
TIP 122	TIP 122	553	2N 3719	BSS 44	214	2N 5494	BD 705	110
TIP 125	TIP 125	558	2N 3720	BSS 44	214	2N 5496	BD 709	110
TIP 126	TIP 126	558	2N 3789	2N 3789	584	2N 5671	2N 5671	624
TIP 127	TIP 127	558	2N 3790	2N 3790	584	2N 5672	2N 5672	624
TIP 130	TIP 130	563	2N 3791	2N 3791	584	2N 5681	BSW 67	218
TIP 131	TIP 131	563	2N 3792	2N 3792	584	2N 5682	BSW 67	218
TIP 132	TIP 132	563	2N 3830	BUY 68	480	2N 5758	BDW 51C	133
TIP 135	TIP 135	565	2N 3831	BUY 68	480	2N 5781	BSS 44	214
TIP 136	TIP 136	565	2N 3924	BUY 68	480	2N 5782	BSS 44	214
TIP 137	TIP 137	565	2N 4234	2N 4234	588	2N 5783	BSS 44	214
TIP 140	TIP 140	567	2N 4235	2N 4235	588	2N 5784	BUY 68	480
TIP 141	TIP 141	567	2N 4236	2N 4236	588	2N 5785	BUY 68	480
TIP 142	TIP 142	567	2N 4895	2N 4895	591	2N 5786	BUY 68	480
TIP 145	TIP 145	567	2N 4896	2N 4896	591	2N 5875	2N 5875	632
TIP 146	TIP 146	567	2N 4897	2N 4897	591	2N 5876	2N 5876	632
TIP 147	TIP 147	567	2N 5038	2N 5038	595	2N 5877	2N 5877	637
TIP 150	BU 910	285	2N 5039	2N 5039	595	2N 5878	2N 5878	637
TIP 151	BU 910	285	2N 5157	BUW 35	359	2N 5879	BDW 52A	138
TIP 152	BU 911	285	2N 5190	2N 5190	607	2N 5880	BDW 52B	138
TIP 660	BU 920P	290	2N 5191	2N 5191	607	2N 5881	BDW 51A	133
TIP 661	BU 920P	290	2N 5192	2N 5192	607	2N 5882	BDW 51B	133
TIP 662	BU 921P	290	2N 5193	2N 5193	611	2N 6032	2N 6032	642
2N 3055E	2N 3055E	572	2N 5194	2N 5194	611	2N 6033	2N 6033	642
2N 3418	2N 3418	*	2N 5195	2N 5195	611	2N 6034	2N 6034	647
2N 3419	2N 3419	*	2N 5241	BUW 34	359	2N 6035	2N 6035	647
2N 3420	2N 3420	*	2N 5294	BD 537	94	2N 6036	2N 6036	647
2N 3421	2N 3421	*	2N 5296	BD 533	94	2N 6037	2N 6037	651
2N 3439	2N 3439	576	2N 5298	BD 535	94	2N 6038	2N 6038	651
2N 3440	2N 3440	576	2N 5333	BSS 44	214	2N 6039	2N 6039	651
2N 3445	BDW 51A	133	2N 5334	BUY 68	480	2N 6040	BDX 54A	173
2N 3446	BDW 51B	133	2N 5335	BUY 47	469	2N 6041	BDX 54B	173
2N 3553	BUY 68	480	2N 5336	2N 5336	615	2N 6042	BDX 54C	173
2N 3554	BUY 68	480	2N 5337	2N 5337	615	2N 6043	BDX 53A	161
2N 3713	2N 3713	580	2N 5338	2N 5338	615	2N 6044	BDX 53B	161
2N 3714	2N 3714	580	2N 5339	2N 5339	615	2N 6045	BDX 53C	161

* Data sheet available on request

TYPE	SGS-ATES NEAREST	PAGE	TYPE	SGS-ATES NEAREST	PAGE	TYPE	SGS-ATES NEAREST	PAGE
2N 6050	2N 6050	655	2N 6292	2N 6292	673	2N 6547	2N 6547	702
2N 6051	2N 6051	655	2N 6306	BUW 34	359	2N 6569	BDW 51	133
2N 6052	2N 6052	655	2N 6307	BUW 35	359	2N 6573	BUW 44	366
2N 6053	2N 6053	660	2N 6308	BUW 35	359	2N 6574	2N 6546	702
2N 6054	2N 6054	660	2N 6338	BUX 10	371	2N 6575	BUW 45	366
2N 6055	2N 6055	664	2N 6339	BUX 10	371	2N 6594	BDW 52	138
2N 6056	2N 6056	664	2N 6340	BUX 11N	383	2N 6648	BDX 88	200
2N 6057	2N 6057	668	2N 6341	BUX 11N	383	2N 6649	BDX 88A	200
2N 6058	2N 6058	668	2N 6354	2N 6354	685	2N 6650	BDX 88B	200
2N 6059	2N 6059	668	2N 6383	BDX 87	195	2N 6666	BDX 54	173
2N 6107	2N 6107	673	2N 6384	BDX 87A	195	2N 6667	BDX 54A	173
2N 6109	2N 6109	673	2N 6385	BDX 87B	195	2N 6668	BDX 54B	173
2N 6111	2N 6111	673	2N 6386	2N 6386	690	2N 6702	2N 6702	705
2N 6121	2N 6121	675	2N 6387	2N 6387	690			
2N 6122	2N 6122	675	2N 6388	2N 6388	690			
2N 6123	2N 6123	675	2N 6469	BDW 52	138			
2N 6124	2N 6124	679	2N 6470	BDW 51	133			
2N 6125	2N 6125	679	2N 6471	BDW 51A	133			
2N 6126	2N 6126	679	2N 6472	BDW 51B	133			
2N 6226	BDW 52C	138	2N 6473	BD 711	110			
2N 6246	BDW 52A	138	2N 6475	BD 712	115			
2N 6247	BDW 52B	138	2N 6486	2N 6486	693			
2N 6249	BUX 41	423	2N 6487	2N 6487	693			
2N 6250	BUX 42	435	2N 6488	2N 6488	693			
2N 6251	BUW 44	366	2N 6489	2N 6489	696			
2N 6274	BUV 20	335	2N 6490	2N 6490	696			
2N 6275	BUV 20	335	2N 6491	2N 6491	696			
2N 6276	BUV 21	335	2N 6496	2N 6496	595			
2N 6277	BUV 21	335	2N 6511	BUW 34	359			
2N 6282	2N 6282	683	2N 6512	BUW 34	359			
2N 6283	2N 6283	683	2N 6513	BUW 34	359			
2N 6284	2N 6284	683	2N 6514	BUW 34	359			
2N 6285	2N 6285	683	2N 6531	BDX 53C	161			
2N 6286	2N 6286	683	2N 6532	BDX 53C	161			
2N 6287	2N 6287	683	2N 6544	2N 6544	699			
2N 6288	2N 6288	673	2N 6545	2N 6545	699			
2N 6290	2N 6290	673	2N 6546	2N 6546	702			

ALPHABETICAL LIST OF SYMBOLS

B	Bandwidth
C_{CBO}	Collector-base capacitance (emitter open to a.c. and d.c.)
d	Distortion
$E_{s/b}$	Second breakdown energy (with base-emitter junction reverse biased)
f	Frequency
f_T	Transition frequency
G_v	Voltage gain
h_{fe}	Common emitter, small-signal value of the short-circuit forward current transfer ratio
h_{FE}	Common emitter, static value of the forward current transfer ratio
h_{FE1}/h_{FE2}	Common emitter, static value of the forward current transfer matched pair ratio
I_B	Base current
I_{B1}	Turn-on current
I_{B2}	Turn-off current
I_{BF}	Base forward current
I_{BFM}	Base forward peak current
I_{BM}	Base peak current
I_{BR}	Base reverse current
I_{BRM}	Base reverse peak current
I_C	Collector current
I_{CBO}	Collector cutoff current with emitter open
I_{CEO}	Collector cutoff current with base open
I_{CER}	Collector cutoff current with specified resistance between emitter and base
I_{CES}	Collector cutoff current with emitter short-circuited to base
I_{CEV}	Collector cutoff current with specified reverse voltage between emitter and base
I_{CM}	Collector peak current
I_d	Drain current
I_E	Emitter current

I_{EBO}	Emitter cutoff current with collector open
I_F	Continuous DC forward current
I_{FM}	Peak forward current
I_R	Continuous DC reverse current
$I_{s/b}$	Second breakdown collector current (with base-emitter junction forward biased)
P_o	Output power of a specified circuit
P_{tot}	Total power dissipation
R_{BB}	Base dropping resistance
R_{BE}	Resistance between base and emitter
R_{CC}	Collector dropping resistance
R_{EE}	Emitter dropping resistance
R_L	Load resistance
R_{th}	Thermal resistance
$R_{th\ j-amb}$	Thermal resistance junction-to-ambient
$R_{th\ j-case}$	Thermal resistance junction-to-case
t	Time
T_{amb}	Ambient temperature
T_{case}	Case temperature
t_f	Fall time
T_j	Junction temperature
t_{off}	Turn-off time
t_{on}	Turn-on time
t_r	Rise time
t_s	Storage time
T_{stg}	Storage temperature
V_{BE}	Base-emitter voltage
$V_{BE(sat)}$	Base-emitter saturation voltage
$V_{(BR)CBO}$	Collector-base breakdown voltage with emitter open
$V_{(BR)CEO}$	Collector-emitter breakdown voltage with base open

ALPHABETICAL LIST OF SYMBOLS (continued)

$V_{(BR) CER}$	Collector-emitter breakdown voltage with specified resistance
$V_{(BR) CES}$	Collector-emitter breakdown voltage with emitter short-circuited to base
$V_{(BR) CEV}$	Collector-emitter breakdown voltage with specified reverse voltage between emitter and base
$V_{(BR) EBO}$	Emitter-base breakdown voltage with collector open
V_{CB}	Collector-base voltage
V_{CBO}	Collector-base voltage with emitter open
V_{CE}	Collector-emitter voltage
V_{CEK}	Knee voltage at specified condition
V_{CEO}	Collector-emitter voltage with base open
$V_{CEO (sus)}$	Collector-emitter sustaining voltage with base open
V_{CER}	Collector-emitter voltage with specified resistance between emitter and base
$V_{CER (sus)}$	Collector-emitter sustaining voltage with specified resistance between emitter and base
$V_{CE (sat)}$	Collector-emitter saturation voltage
V_{CES}	Collector-emitter voltage with emitter short-circuited to base
V_{CEV}	Collector-emitter voltage with specified reverse voltage between emitter and base
$V_{CEV (sus)}$	Collector-emitter sustaining voltage with specified reverse voltage between emitter and base
$V_{CEX (sus)}$	Collector-emitter sustaining voltage with specified circuit between emitter and base
V_{EB}	Emitter-base voltage
V_{EBO}	Emitter-base voltage with collector open
V_F	Continuous DC forward voltage
V_i	Input voltage of a specified circuit
V_R	Continuous DC reverse voltage
V_{RM}	Peak reverse voltage
Z_{BE}	Impedance between base and emitter
Z_i	Input impedance

RATING SYSTEMS FOR ELECTRONIC DEVICES

A. DEFINITIONS OF TERMS USED

- a. **Electronic device.** An electronic tube or valve, transistor or other semiconductor device.
Note: This definition excludes inductors, capacitors, resistors and similar components.
- b. **Characteristic.** A characteristic is an inherent and measurable property of a device. Such a property may be electrical, mechanical, thermal, hydraulic, electro-magnetic, or nuclear, and can be expressed as a value for stated or recognized conditions. A characteristic may also be a set of related values, usually shown in graphical form.
- c. **Bogey electronic device.** An electronic device whose characteristics have the published nominal values for the type. A bogey electronic device for any particular application can be obtained by considering only those characteristics which are directly related to the application.
- d. **Rating.** A value which establishes either a limiting capability or a limiting condition for an electronic device. It is determined for specified values of environment and operation, and may be stated in any suitable terms.
Note: Limiting conditions may be either maxima or minima.
- e. **Rating system.** The set of principles upon which ratings are established and which determines their interpretation.
Note: The rating system indicates the division of responsibility between the device manufacturer and the circuit designer, with the object of ensuring that the working conditions do not exceed the ratings.

B. ABSOLUTE MAXIMUM RATING SYSTEM

Absolute maximum ratings are limiting values of operating and environmental conditions applicable to any electronic device of a specified type as defined by its published data, which should not be exceeded under the worst probable conditions.

These values are chosen by the device manufacturer to provide acceptable serviceability of the device, taking no responsibility for equipment variations, environmental variations, and the effects of changes in operating conditions due to variations in the characteristics of the device under consideration and of all other electronic devices in the equipment.

The equipment manufacturer should design so that, initially and throughout life, no absolute maximum value for the intended service is exceeded with any device under the worst probable operating conditions with respect to supply voltage variation, equipment component variation, equipment control adjustment, load variations, signal variation, environmental conditions, and variations in characteristics of the device under consideration and of all other electronic devices in the equipment.

RATING SYSTEMS FOR ELECTRONIC DEVICES (continued)

C. DESIGN - MAXIMUM RATING SYSTEM

Design-maximum ratings are limiting values of operating and environmental conditions applicable to a bogey electronic device of a specified type as defined by its published data, and should not be exceeded under the worst probable conditions.

These values are chosen by the device manufacturer to provide acceptable serviceability of the device, taking responsibility for the effects of changes in operating conditions due to variations in the characteristics of the electronic device under consideration.

The equipment manufacturer should design so that, initially and throughout life, no design-maximum value for the intended service is exceeded with a bogey device under the worst probable operating conditions with respect to supply-voltage variation, equipment, component variation, variation in characteristics of all other devices in the equipment, equipment control adjustment, load variation, signal variation and environmental conditions.

D. DESIGN - CENTRE RATING SYSTEM

Design-centre ratings are limiting values of operating and environmental conditions applicable to a bogey electronic device of a specified type as defined by its published data, and should not be exceeded under normal conditions.

These values are chosen by the device manufacturer to provide acceptable serviceability of the device in average applications, taking responsibility for normal changes in operating conditions due to rated supply-voltage variation, equipment component variation, equipment control adjustment, load variation, signal variation, environmental conditions, and variations in the characteristics of all electronic devices.

The equipment manufacturer should design so that, initially, no design-centre value for the intended service is exceeded with a bogey electronic device in equipment operating at the stated normal supply-voltage.

The Absolute Maximum Rating System is commonly used for semiconductor devices.

QUALITY

- 100% ELECTRICAL TESTING
- MARKING
- GROUP A ACCEPTANCE
- PACKING
- PACKING AND DOCUMENTATION ACCEPTANCE
- SHIPPING

GROUP A ACCEPTANCE

Sub-group	Parameters	Temp. °C	Insp. Level	Acceptable quality level (AQL)
				Hermetic and molded packages
A1	Visual and Mechanical Inspection, Major Minor		I	0.25 1
*A2	Inoperative failure (electrical and mechanical)	25°C	II	0.15
A3	DC parameters	25°C	II	0.65
	h_{FE} ranges \square			1
A4	AC parameters at 25°C and DC parameters at high temperature		S4	2.5

\square Applicable when h_{FE} is guaranteed as min and max

* Definition of electrical inoperative:

- open or short circuit
- < 80% of guaranteed spec value for: BV_{CBO} , BV_{CEO} , BV_{CER} , BV_{CES} , BV_{CEV} , BV_{EBO}
- > 200% of guaranteed spec value for: $V_{CE(sat)}$
- > 200% of guaranteed spec value for: I_{CBO} , I_{CES} , I_{CEO} , I_{CEV} at 50% guaranteed BV value
- > 150% of guaranteed max spec values for h_{FE}
- < 50% of guaranteed min spec values for h_{FE}

For further information Quality and Reliability see the SGS SURE 3 programme.

PRECAUTIONS FOR PHYSICAL HANDLING OF POWER PLASTIC TRANSISTOR [TO-220, SOT-93, TO-126 (SOT-32)]

When mounting power transistors certain precautions must be taken in operations such as bending of leads, mounting of heatsink, soldering and removal of flux residue. If these operations are not carried out correctly, the device can be damaged or reliability compromised.

1. Bending and cutting leads

The bending or cutting of the leads requires the following precautions:

- 1.1. When bending the leads they must be clamped tightly between the package and the bending point to avoid strain on the package (in particular in the area where the leads enter the resin) (fig. 1). This also applies to cutting the leads (fig. 2).
- 1.2. The leads must be bent at a minimum distance of 3 mm from the package (fig. 3a).
- 1.3. The leads should not be bent at an angle of more than 90° and they must be bent only once (fig. 3b).
- 1.4. The leads must never be bent laterally (fig. 3c).
- 1.5. Check that the tool used to cut or form the leads does not damage them or ruin their surface finish.

Fig. 1 - Bending the leads

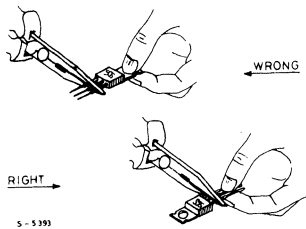

Fig. 2 - Lead forming or cutting mechanism

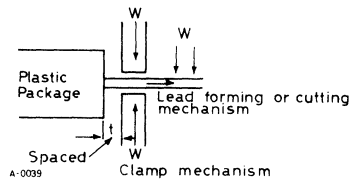
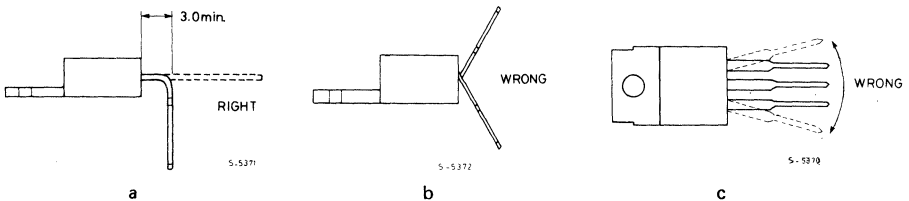

Fig. 3 - Angles for lead wire bending



2. Mounting on printed circuit

During mounting operations be careful not to apply stress to the power transistor.

- 2.1. Adhere strictly to the pin spacing of the transistor to avoid forcing the leads.
- 2.2. Leave a suitable space between printed circuit and transistor, if necessary use a spacer.
- 2.3. When fixing the device to the printed circuit do not put mechanical stress on the transistor. For this purpose the device should be soldered to the printed circuit board after the Transistor has been fixed to the heatsink and the heatsink to the printed circuit board.

3. Soldering

In general a transistor should never be exposed to high temperature for any length of time. It is therefore preferable to use soldering methods where the transistor is exposed to the lowest possible temperatures for a short time.

- 3.1. Tolerable conditions are 260°C for 10 sec or 350°C for 3 sec. The graphs in fig. 4 give an idea of the excess junction temperature during the soldering process for a TO-220 (Versawatt). It is also important to use suitable fixes for the tin baths to avoid deterioration of the leads or of the package resin.
- 3.2. An excess of residual flux between the pins of the transistor or in contact with the resin can reduce the long-term reliability of the device. The solvent for removing excess flux must be chosen with care. The use of solvents derived from trichloroethylene is not recommended on plastic packages because the residue can cause corrosion.

Fig. 4 - Junction temperatures during soldering

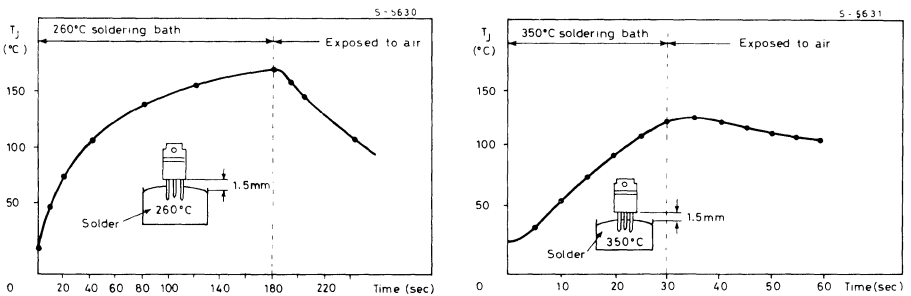

4. Mounting at heatsink

To exploit best the performance of power transistors a heatsink with R_{th} suitable for the power that the transistor will dissipate must be used.

4.1. The plastic packages used by SGS for its power transistors (SOT-32, SOT-93, Versawatt) provide for the use of a single screw to fix the package to the heatsink. A compression spring (clip) can be sufficient as an alternative (fig. 5).

Fig. 5 - SOT-93 mounting examples

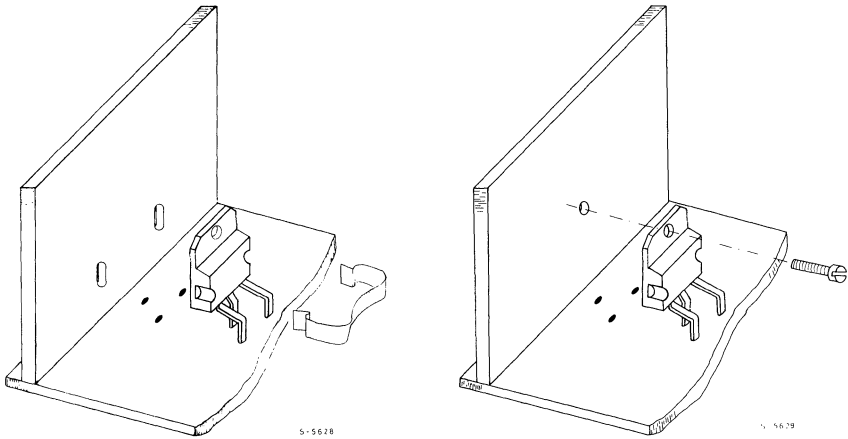

The screw should be properly tightened to ensure good contact between the back of the package and the heatsink but should not be too tight to avoid deformation of the copper part (tab) of the package causing breaking of the die or separation of the resin from the tab.

4.2. The contact R_{th} between device and heatsink can be improved by inserting a thin layer of silicone grease with fluidity sufficient to guarantee perfectly uniform distribution on the surface of the tab. The thermal resistance with and without silicone grease is given in fig. 6. An excessively thick layer or an excessive viscosity of the grease can degrade the R_{th} .

5. Heatsink problems

The most important aspect from the point of view of reliability of a power transistor is that the heatsink should be dimensioned to keep the T_j of the device as low as possible. From the mechanical point of view, however, the heatsink must be realized so that it does not damage the device.

Fig. 6 - Contact thermal resistance vs. insulator thickness.

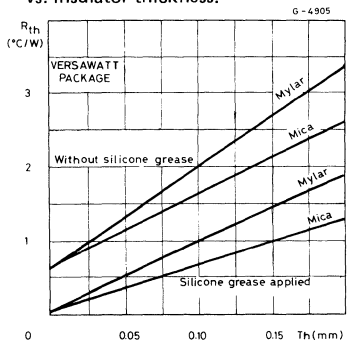

- 5.1. The planarity of the contact surface between device and heatsink must be $< 25 \mu\text{m}$ for TO-220, SOT-93, TO-126 (SOT-32).
- 5.2. If self threading screws are used there must be an outlet for the material that is deformed during formation of the thread. The diameter $\phi 1$ (fig. 7) must be large enough to avoid distortion of the

Fig. 7 – Device mounting

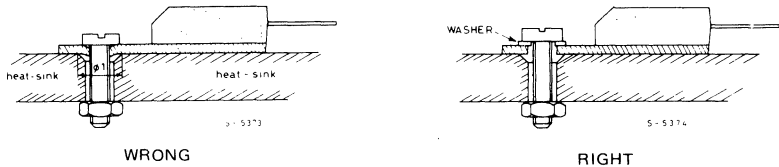

tab during tightening. For this purpose it may be useful to insert a washer or use screws of the type shown in fig. 8 where the pressure on the tab is distributed on a much larger surface. Sometimes when the hole in the heatsink is formed with a punch, around the hole or hollow there may be a ring which is lower than the heatsink surface. This is dangerous because it may lead to distortion of the tab as mentioned before.

Fig. 8 – Suggested screw



- 5.3. A very serious problem is that of the rigidity between heatsink, device and printed circuit board. Once the device and the heatsink are mechanically connected, and the heatsink is fixed to the apparatus frame, the device and the PCB are bound together by the leads of the devices. A solution of this type is extremely dangerous.

ACCESSORIES AND MOUNTING INSTRUCTIONS

TO-3

ACCESSORY		ASSEMBLY NUMBER	MATERIAL	MECH. DATA
TYPE	Qty			
CHEESE HEAD SCREWS SLOTTED	2	NOT AVAILABLE FROM SGS		
MICA WASHER	1	* CDA 3126A	MICA	43
INSULATING BUSHES	2	CDA 3155A	NYLON	44
WASHERS	2	NOT AVAILABLE FROM SGS		
LOCK WASHERS	2	NOT AVAILABLE FROM SGS		
HEXAGON NUTS	4	NOT AVAILABLE FROM SGS		
SOLDER LUG	1	NOT AVAILABLE FROM SGS		

S-0379/3

* CDA 3126B FOR MODIFIED TO-3 (see 2N6032 and 2N6033)

Maximum torque (applied to mounting flange)
 Recommended: 0.55 Nm
 Maximum: 1 Nm.

SOT-93

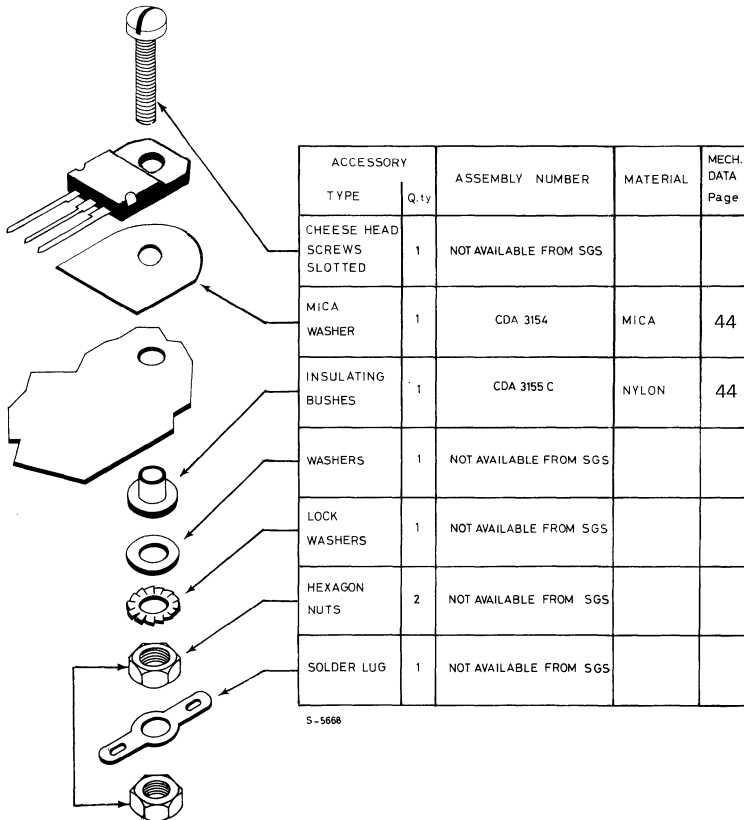

Maximum torque (applied to mounting flange)
 Recommended: 0.55 Nm
 Maximum: 1 Nm.

ACCESSORIES AND MOUNTING INSTRUCTIONS (continued)

TO-126 (SOT-32)

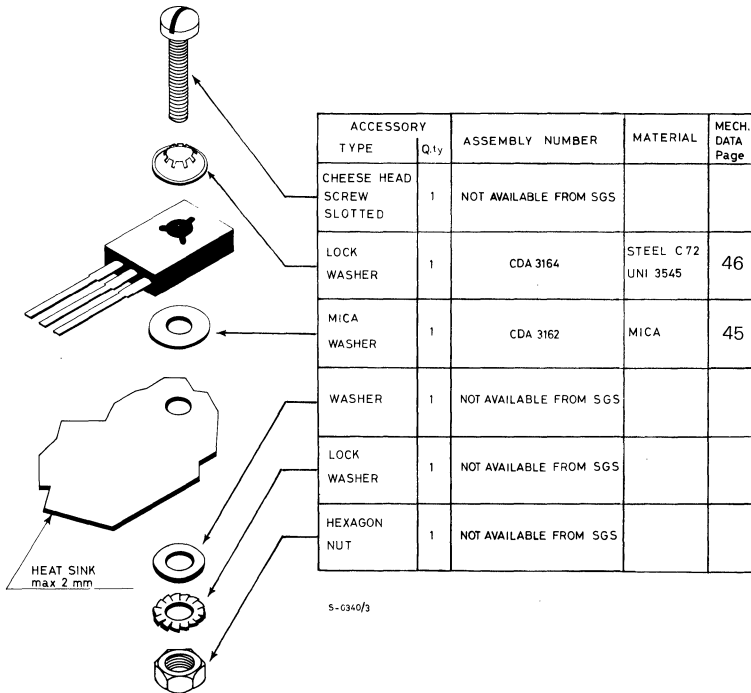

Maximum torque (applied to mounting flange)
 Recommended: 0.55 Nm
 Maximum: 0.7 Nm.

TO-220

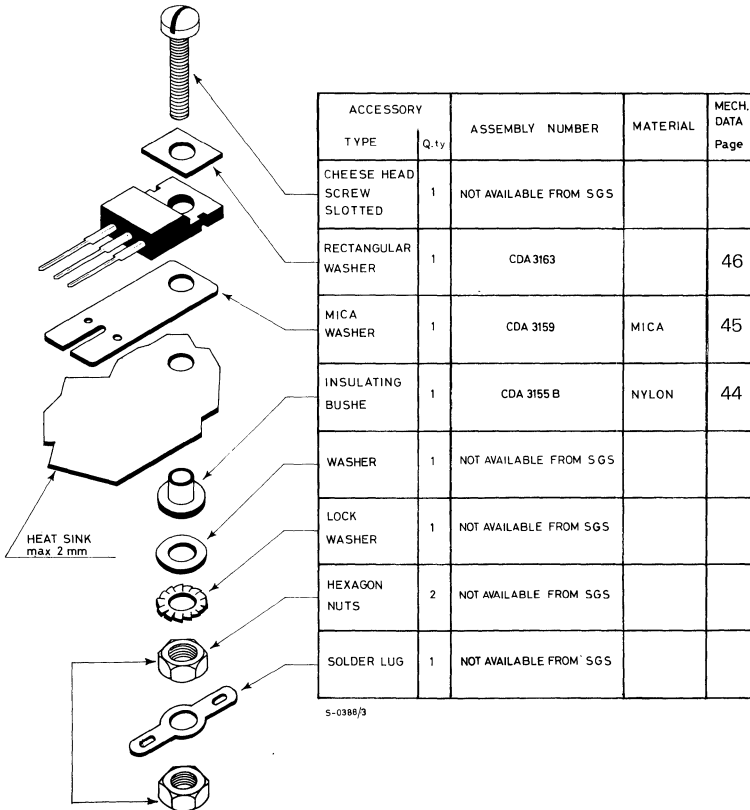

Maximum torque (applied to mounting flange)
 Recommended: 0.55 Nm
 Maximum: 0.7 Nm.

ACCESSORIES AND MOUNTING INSTRUCTIONS (continued)

TO-220

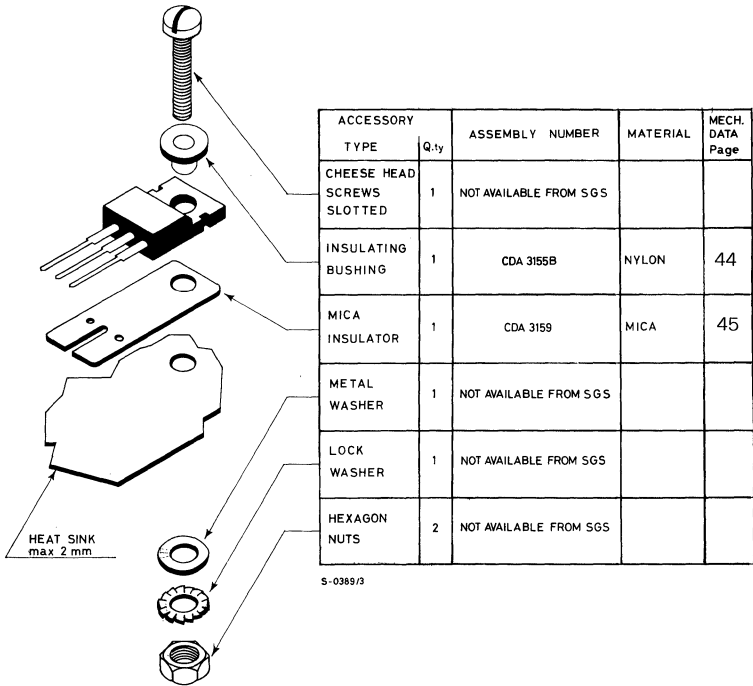

Maximum torque (applied to mounting flange)
 Recommended: 0.55 Nm
 Maximum: 0.7 Nm.

CDA 3126A

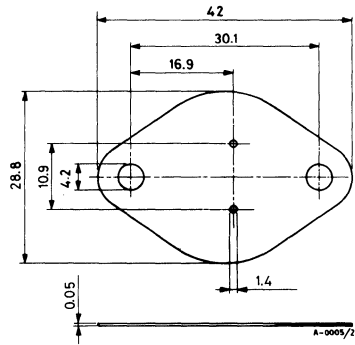

CDA 3126B

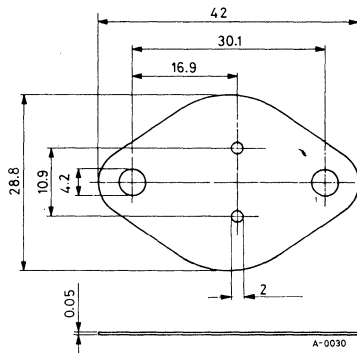

ACCESSORIES AND MOUNTING INSTRUCTIONS (continued)

CDA 3154

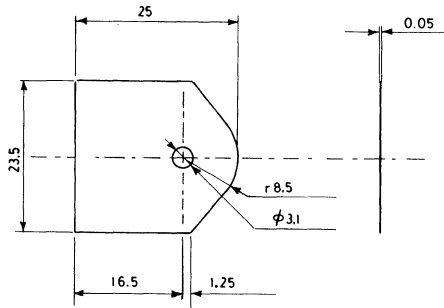

A-0042

CDA 3155

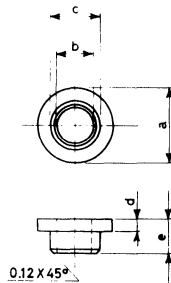

A - 0024/2

Suffix	Package	a	b	c	d	e
A	TO-3	6.40 to 6.60	3.00 to 3.10	4.00 to 4.05	1.1 max	1.55 to 1.65
B	TO-220	5.30 to 5.50	3.00 to 3.10	3.83 to 3.88	0.60 to 0.65	1.70 to 1.80
C	SOT-93	6.40 to 6.60	3.00 to 3.10	4,00 to 4,05	1.3 to 1.4	2.7 to 2.9

Material: Nylon; Dimensions: mm.

CDA 3159

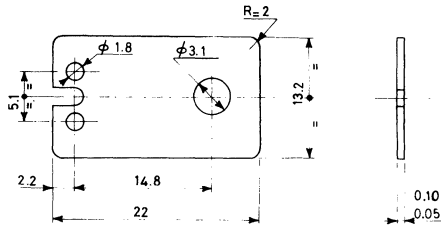

A-0026/3

TYPE	MATERIAL	NOTE
CDA 3159	MICA	

CDA 3162

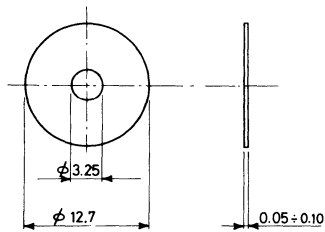

A-0025/3

TYPE	MATERIAL	NOTE
CDA 3162	MICA	

ACCESSORIES AND MOUNTING INSTRUCTIONS (continued)

CDA 3163

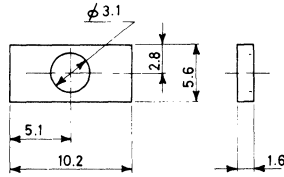

A-0023/3

TYPE	MATERIAL	NOTE
CDA 3163	Steel nickel plated	

CDA 3164

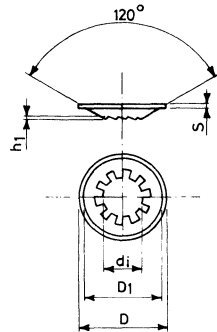

A-0022/1

TYPE	max ^{di}	min	max ^D	min	D ₁	S	h ₁	NOTE
CDA3164	3.3	3.1	7.1	6.8	52	0.4	0.8	

MATERIAL: Steel nickel plated

DATA SHEETS



**BD175
BD177
BD179**

EPITAXIAL-BASE NPN

MEDIUM POWER LINEAR AND SWITCHING APPLICATIONS

The BD 175, BD 177 and BD 179 are silicon epitaxial-base NPN power transistors in Jedec TO-126 plastic package intended for use in medium power linear and switching applications.

The complementart PNP types are the BD 176, BD 178 and BD 180.

ABSOLUTE MAXIMUM RATINGS

		BD 175	BD 177	BD 179
V_{CBO}	Collector-base voltage ($I_E = 0$)	45V	60V	80V
V_{CEO}	Collector-emitter voltage ($I_B = 0$)	45V	60V	80V
V_{EBO}	Emitter-base voltage ($I_C = 0$)		5V	
I_C	Collector current		3A	
I_{CM}	Collector peak current		7A	
P_{tot}	Total power dissipation at $T_{case} \leq 25^\circ C$		30W	
T_{stg}	Storage temperature		-65 to 150°C	
T_j	Junction temperature		150°C	

INTERNAL SCHEMATIC DIAGRAM

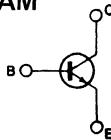

MECHANICAL DATA

Dimensions in mm

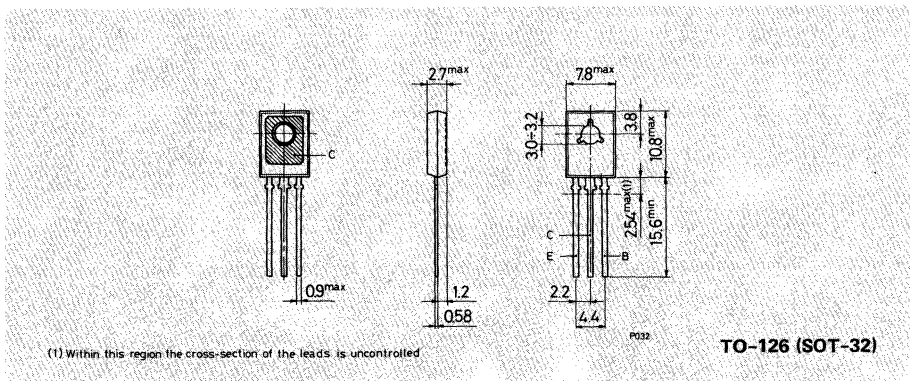



BD175
BD177
BD179

THERMAL DATA

$R_{th\ j-case}$	Thermal resistance junction-case	max	4.16 °C/W
------------------	----------------------------------	-----	-----------

ELECTRICAL CHARACTERISTICS ($T_{case} = 25^{\circ}C$ unless otherwise specified)

Parameter	Test conditions	Min.	Typ.	Max.	Unit
I_{CBO} Collector cutoff current ($I_E = 0$)	for BD175 $V_{CB} = 45V$ for BD177 $V_{CB} = 60V$ for BD179 $V_{CB} = 80V$		100		μA
I_{EBO} Emitter cutoff current ($I_C = 0$)	$V_{EB} = 5V$		1		mA
$V_{CEO(sus)}$ *Collector-emitter sustaining voltage	$I_C = 100\text{ mA}$ for BD175 for BD177 for BD179	45			V
$V_{CE(sat)}$ * Collector-emitter saturation voltage	$I_C = 1A$ $I_B = 0.1A$		0.8		V
V_{BE} * Base-emitter voltage	$I_C = 1A$ $V_{CE} = 2V$		1.3		V
h_{FE} * DC current gain	$I_C = 150\text{ mA}$ $V_{CE} = 2V$ $I_C = 1A$ $V_{CE} = 2V$	40			—
f_T Transistion frequency	$I_C = 250\text{ mA}$ $V_{CE} = 10V$	3			MHz

* Pulsed: pulse duration = 300 μs , duty cycle $\leq 1.5\%$

Safe operating areas

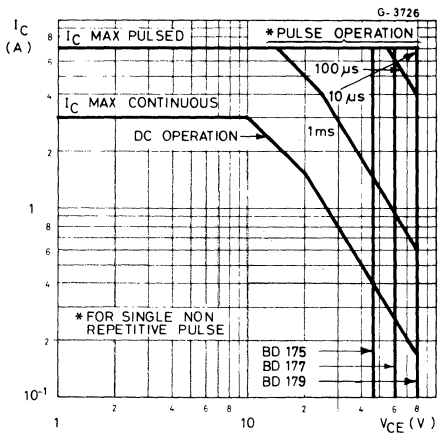

DC current gain

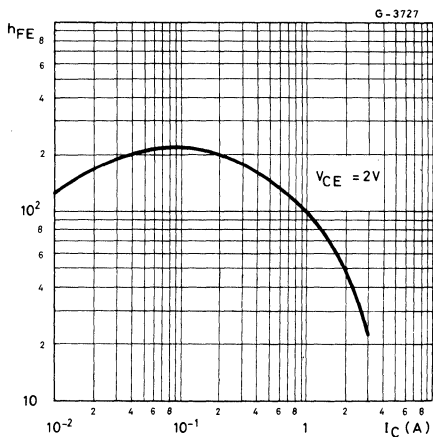

DC transconductance

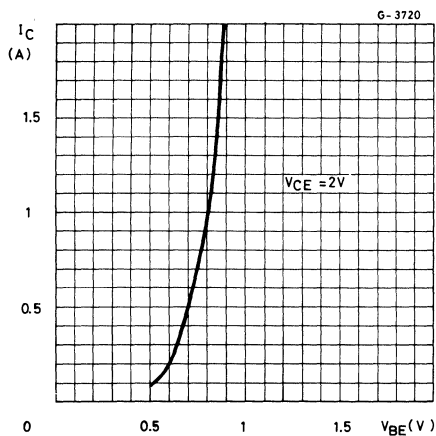

Collector-emitter saturation voltage

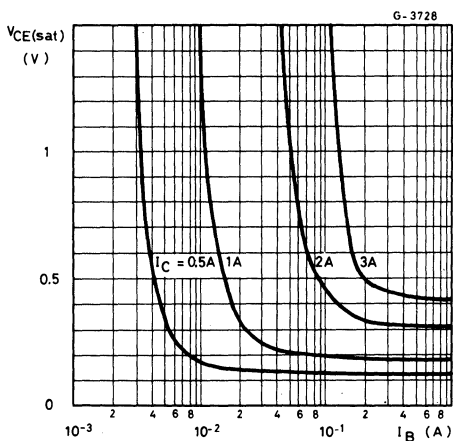

Collector-emitter saturation voltage

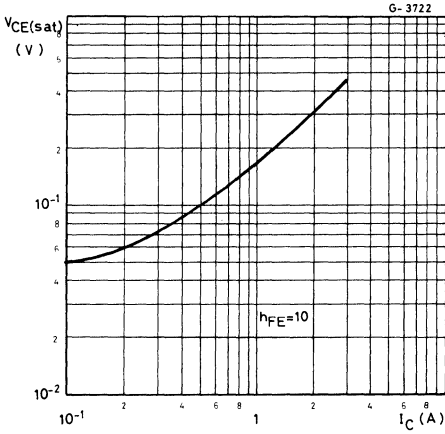

Base-emitter saturation voltage

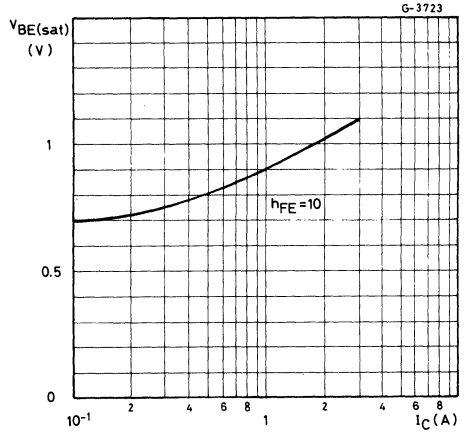

Saturated switching characteristics

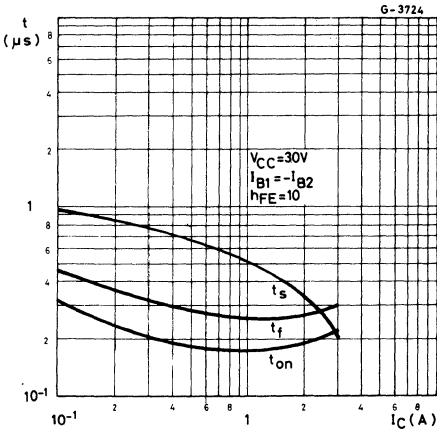

Power derating chart

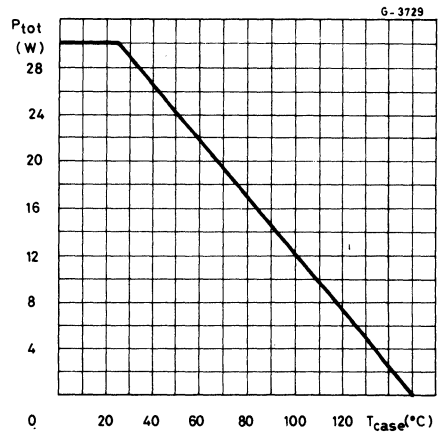



**BD176
BD178
BD180**

EPITAXIAL-BASE PNP

MEDIUM POWER LINEAR AND SWITCHING APPLICATIONS

The BD 176, BD 178 and BD 180 are silicon epitaxial-base PNP power transistors in Jedec TO-126 plastic package intended for use in medium power linear and switching applications.

The complementary NPN types are the BD 175, BD 177 and BD 179.

ABSOLUTE MAXIMUM RATINGS

		BD 176	BD 178	BD 180
V_{CBO}	Collector-base voltage ($I_E = 0$)	-45V	-60V	-80V
V_{CEO}	Collector-emitter voltage ($I_B = 0$)	-45V	-60V	-80V
V_{EBO}	Emitter-base voltage ($I_C = 0$)		-5V	
I_C	Collector current		-3A	
I_{CM}	Collector peak current		-7A	
P_{tot}	Total power dissipation at $T_{case} \leq 25^\circ C$		30W	
T_{stg}	Storage temperature		-65 to 150°C	
T_j	Junction temperature		150°C	

INTERNAL SCHEMATIC DIAGRAM

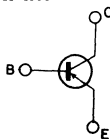

MECHANICAL DATA

Dimensions in mm

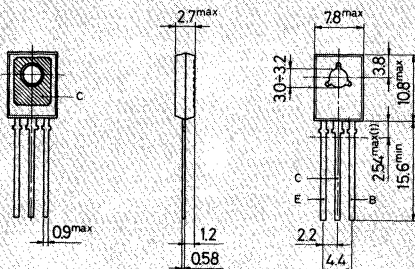

(1) Within this region the cross-section of the leads is uncontrolled

P032

TO-126 (SOT-32)

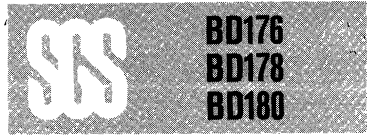

THERMAL DATA

$R_{th\ j-case}$	Thermal resistance junction-case	max	4.16 °C/W
------------------	----------------------------------	-----	-----------

ELECTRICAL CHARACTERISTICS (T_{case} = 25°C unless otherwise specified)

Parameter	Test conditions	Min. Typ. Max.	Unit
I_{CBO} Collector cutoff current ($I_E = 0$)	for BD176 $V_{CB} = -45V$ for BD178 $V_{CB} = -60V$ for BD180 $V_{CB} = -80V$	-100 -100 -100	μA μA μA
I_{EBO} Emitter cutoff current ($I_C = 0$)	$V_{EB} = -5V$	-1	mA
$V_{CEO(sus)}$ *Collector-emitter sustaining voltage	$I_C = -100\text{ mA}$ for BD176 for BD178 for BD180	-45 -60 -80	V V V
$V_{CE(sat)}$ * Collector-emitter saturation voltage	$I_C = -1A$ $I_B = -0.1A$	-0.8	V
V_{BE} * Base-emitter voltage	$I_C = -1A$ $V_{CE} = -2V$	-1.3	V
h_{FE} * DC current gain	$I_C = -150\text{ mA}$ $V_{CE} = -2V$ $I_C = -1A$ $V_{CE} = -2V$	40 15	— —
f_T Transistion frequency	$I_C = -250\text{ mA}$ $V_{CE} = -10V$	3	MHz

* Pulsed: pulse duration = 300 μs , duty cycle $\leq 1.5\%$



BD176
BD178
BD180

Safe operating areas

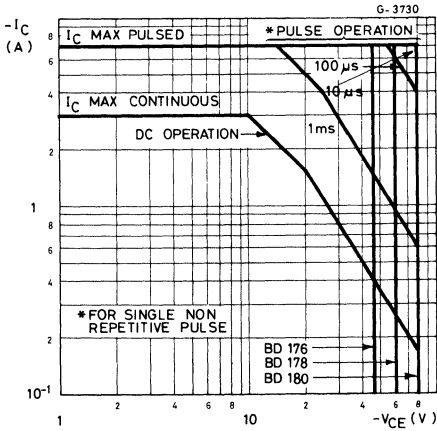

DC current gain

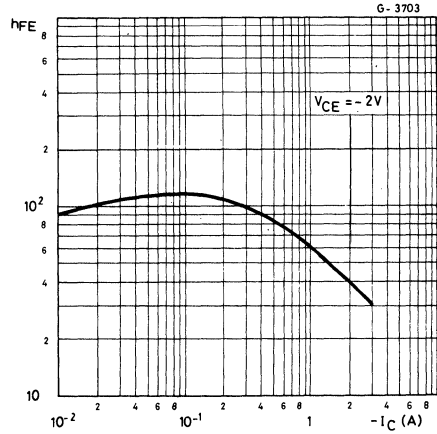

DC transconductance

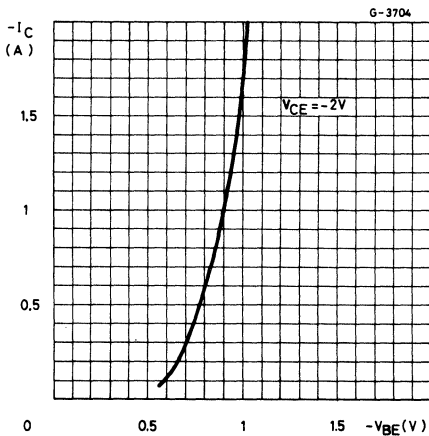

Collector-emitter saturation voltage

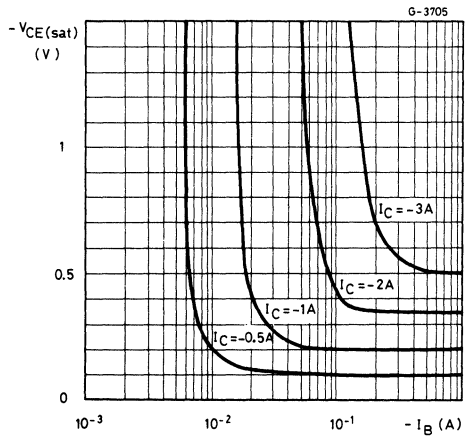

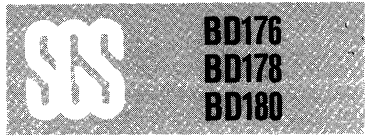

Collector-emitter saturation voltage

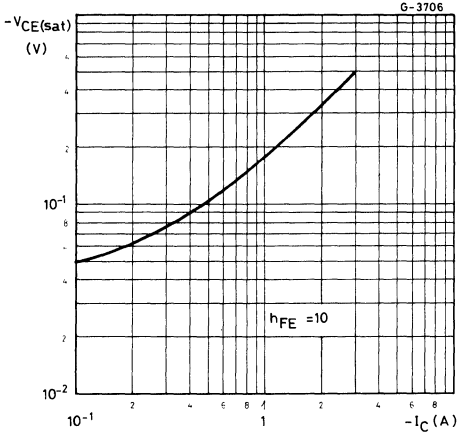

Base-emitter saturation voltage

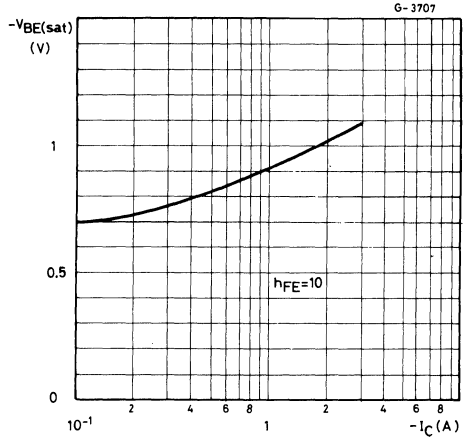

Saturated switching characteristics

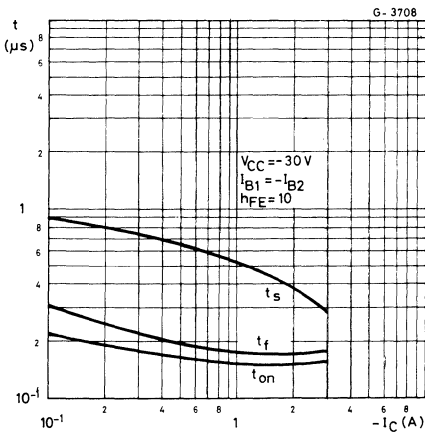

Power derating chart

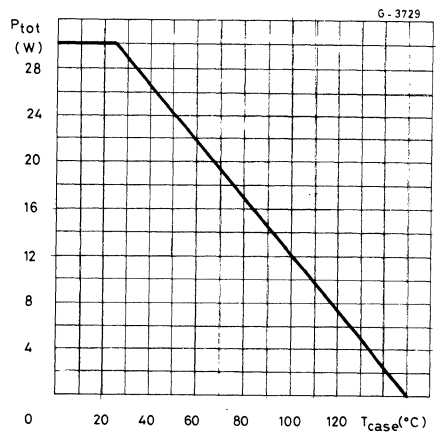



BD233
BD235
BD237

EPITAXIAL-BASE NPN

MEDIUM POWER LINEAR AND SWITCHING APPLICATIONS

The BD 233, BD 235 and BD 237 are silicon epitaxial-base NPN power transistors in Jedec TO-126 plastic package intended for use in medium power linear and switching applications.

The complementary PNP types are the BD 234, BD 236 and BD 238 respectively.

ABSOLUTE MAXIMUM RATINGS

		BD 233	BD 235	BD 237
V_{CBO}	Collector-base voltage ($I_E=0$)	45V	60V	100V
V_{CEO}	Collector-emitter voltage ($I_B=0$)	45V	60V	80V
V_{CER}	Collector-emitter voltage ($R_{BE}=1K\Omega$)	45V	60V	100V
V_{EBO}	Emitter-base voltage ($I_C=0$)		5V	
I_C	Collector current		2A	
I_{CM}	Collector peak current		6A	
P_{tot}	Total power dissipation at $T_{case} \leq 25^\circ C$		25W	
T_{stg}	Storage temperature		-65 to 150°C	
T_j	Junction temperature		150°C	

INTERNAL SCHEMATIC DIAGRAM

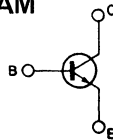

MECHANICAL DATA

Dimensions in mm

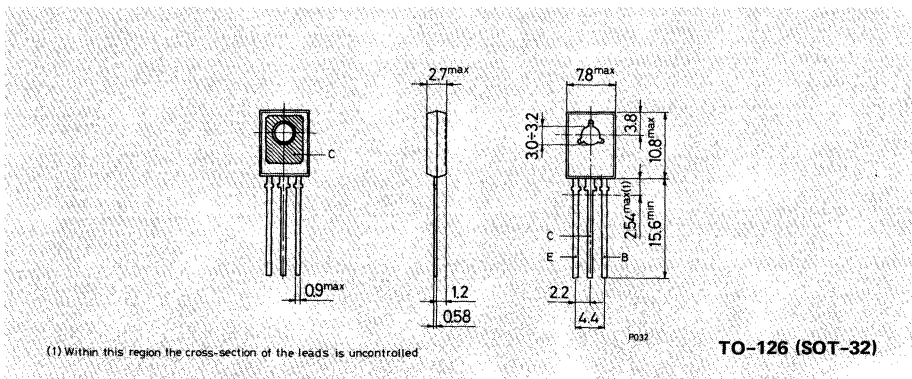

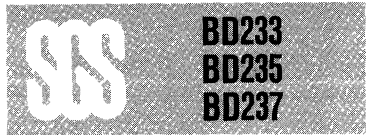

THERMAL DATA

$R_{th\ j-case}$	Thermal resistance junction-case	max	5	°C/W
------------------	----------------------------------	-----	---	------

ELECTRICAL CHARACTERISTICS ($T_{case} = 25^{\circ}C$ unless otherwise specified)

Parameter	Test conditions	Min.	Typ.	Max.	Unit
I_{CBO} Collector cutoff current ($I_E = 0$)	for BD233 $V_{CB} = 45V$ for BD235 $V_{CB} = 60V$ for BD237 $V_{CB} = 100V$ $T_{case} = 150^{\circ}C$ for BD233 $V_{CB} = 45V$ for BD235 $V_{CB} = 60V$ for BD237 $V_{CB} = 100V$		100	100	μA μA μA 2 2 2 mA mA mA
I_{EBO} Emitter cutoff current ($I_C = 0$)	$V_{EB} = 5V$		1		mA
$V_{CEO(sus)}$ *Collector-emitter sustaining voltage	$I_C = 100\ mA$ for BD233 for BD235 for BD237	45		80	V V V
$V_{CE(sat)}$ * Collector-emitter saturation voltage	$I_C = 1A$ $I_B = 0.1A$		0.6		V
V_{BE} * Base-emitter voltage	$I_C = 1A$ $V_{CE} = 2V$		1.3		V
h_{FE} * DC current gain	$I_C = 150mA$ $V_{CE} = 2V$ $I_C = 1A$ $V_{CE} = 2V$	40		25	— —
f_T Transistion frequency	$I_C = 250mA$ $V_{CE} = 10V$	3			MHz
h_{FE1}/h_{FE2} *Matched pairs BD233/BD234 BD235/BD236 BD237/BD238	$I_C = 150mA$ $V_{CE} = 2V$		1.6		—

* Pulsed: pulse duration = 300 μs , duty cycle $\leq 1.5\%$

Safe operating areas

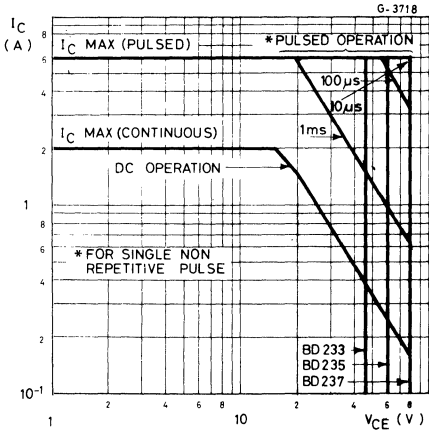

DC current gain

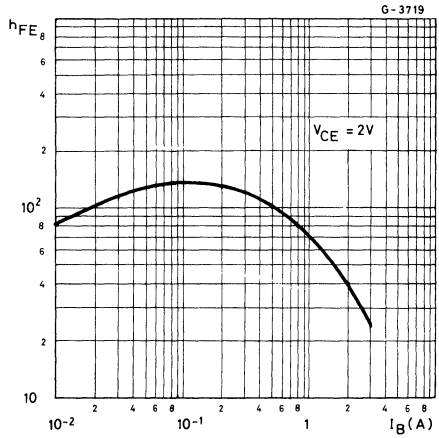

DC transconductance

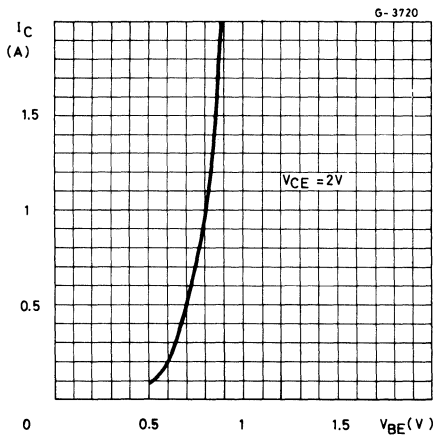

Collector-emitter saturation voltage

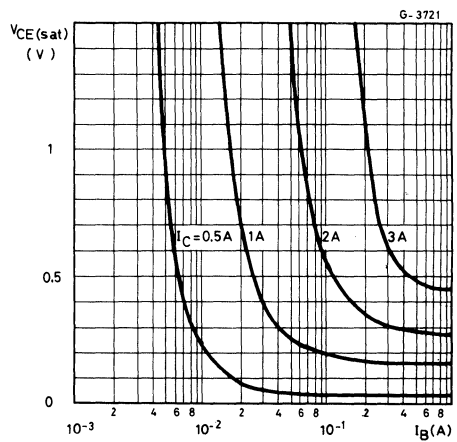

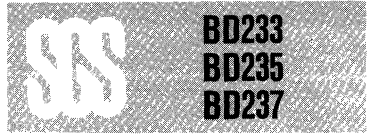

Collector-emitter saturation voltage

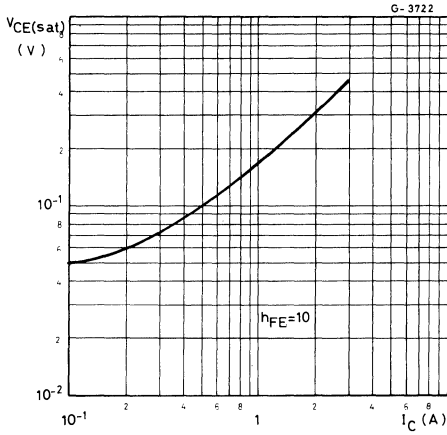

Base-emitter saturation voltage

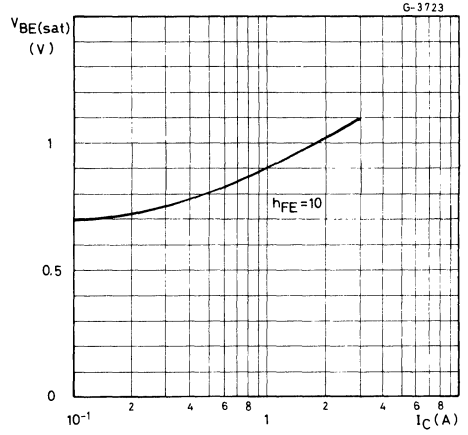

Saturated switching characteristics

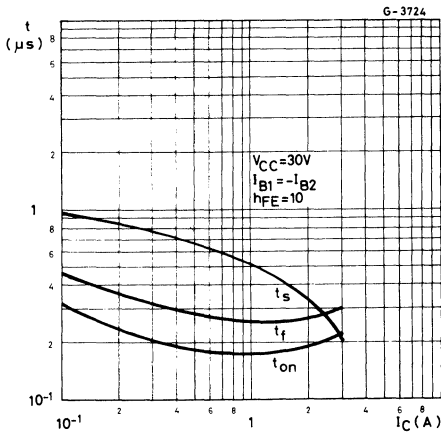

Power derating chart

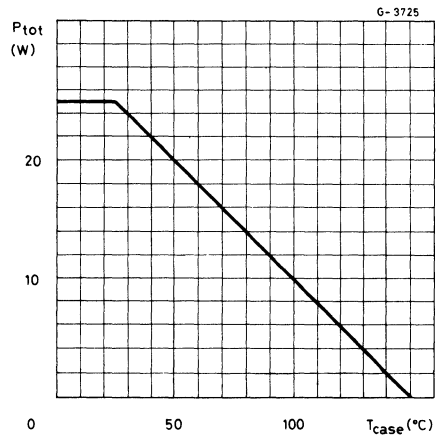



BD234
BD236
BD238

EPITAXIAL-BASE PNP

MEDIUM POWER LINEAR AND SWITCHING APPLICATIONS

The BD 234, BD 236 and BD 238 are silicon epitaxial-base PNP power transistors in Jedec TO-126 plastic-package intended for use in medium power linear and switching applications.

The complementary NPN types are the BD 233, BD 235 and BD 237 respectively.

ABSOLUTE MAXIMUM RATINGS

		BD234	BD236	BD238
V_{CBO}	Collector-base voltage ($I_E = 0$)	-45V	-60V	-100V
V_{CEO}	Collector-emitter voltage ($I_B = 0$)	-45V	-60V	-80V
V_{CER}	Collector-emitter voltage ($R_{BE} = 1K\Omega$)	-45V	-60V	-100V
V_{EBO}	Emitter-base voltage ($I_C = 0$)		-5V	
I_C	Collector current		-2A	
I_{CM}	Collector peak current		-6A	
P_{tot}	Total power dissipation at $T_{case} \leq 25^\circ C$		25W	
T_{stg}	Storage temperature		-65 to 150°C	
T_j	Junction temperature		150°C	

INTERNAL SCHEMATIC DIAGRAM

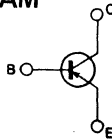

MECHANICAL DATA

Dimensions in mm

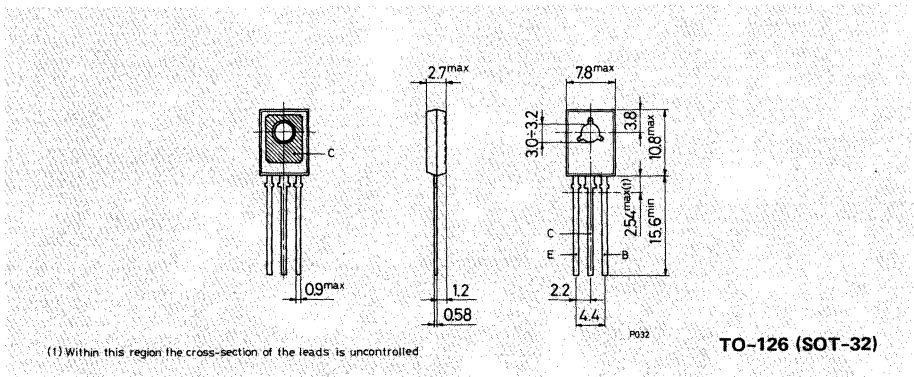

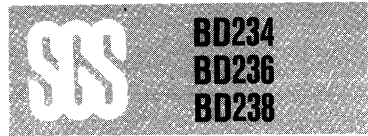

THERMAL DATA

$R_{th\ j-case}$	Thermal resistance junction-case	max	5	°C/W
------------------	----------------------------------	-----	---	------

ELECTRICAL CHARACTERISTICS ($T_{case} = 25^{\circ}C$ unless otherwise specified)

Parameter	Test conditions	Min.	Typ.	Max.	Unit
I_{CBO} Collector cutoff current ($I_E = 0$)	for BD234 $V_{CB} = -45V$			-100	μA
	for BD236 $V_{CB} = -60V$			-100	μA
	for BD238 $V_{CB} = -100V$			-100	μA
	$T_{case} = 150^{\circ}C$				
	for BD234 $V_{CB} = -45V$			-2	mA
	for BD236 $V_{CB} = -60V$			-2	mA
	for BD238 $V_{CB} = -100V$			-2	mA
I_{EBO} Emitter cutoff current ($I_C = 0$)	$V_{EB} = -5V$			-1	mA
$V_{CEO(sus)}$ *Collector-emitter sustaining voltage ($I_B = 0$)	$I_C = -100\text{ mA}$ for BD234 for BD236 for BD238			-45 -60 -80	V V V
$V_{CE(sat)}$ * Collector-emitter saturation voltage	$I_C = -1A$ $I_B = -0.1A$			-0.6	V
V_{BE} * Base-emitter voltage	$I_C = -1A$ $V_{CE} = -2V$			-1.3	V
h_{FE} * DC current gain	$I_C = -150\text{ mA}$ $V_{CE} = -2V$			40	—
	$I_C = -1A$ $V_{CE} = -2V$			25	—
f_T Transistion frequency	$I_C = -250\text{ mA}$ $V_{CE} = -10V$			3	MHz
h_{FE1}/h_{FE2} * Matched pairs BD233/BD234 BD235/BD236 BD237/BD238	$I_C = 150\text{ mA}$ $V_{CE} = 2V$			1.6	—

* Pulsed: pulse duration = 300 μs , duty cycle $\leq 1.5\%$

Safe operating areas

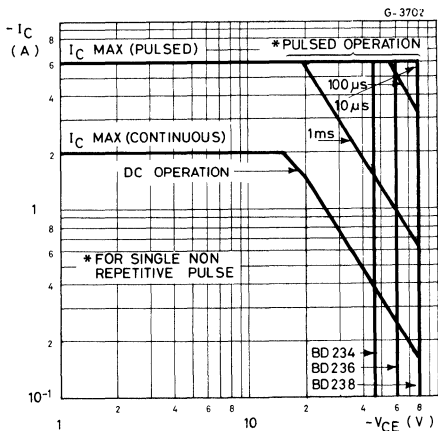

DC current gain

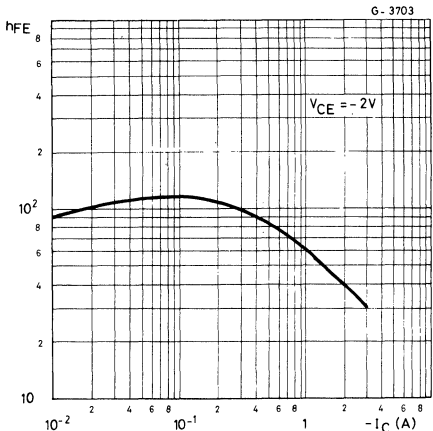

DC transconductance

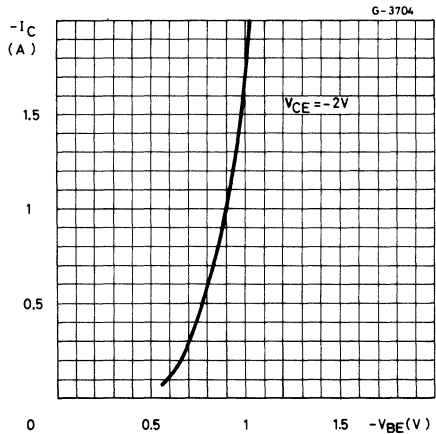

Collector-emitter saturation voltage

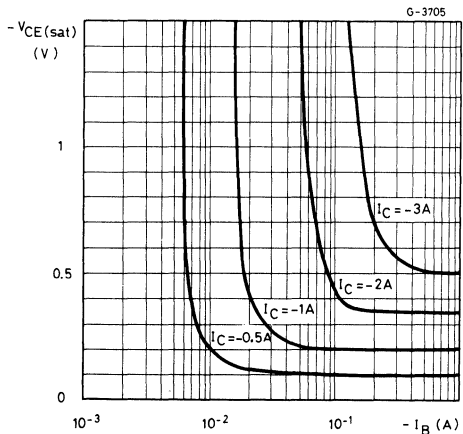

Collector-emitter saturation voltage

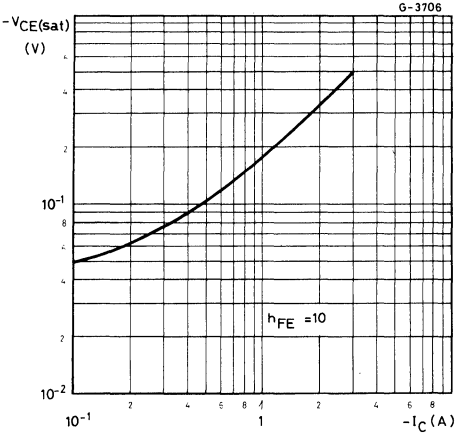

Base-emitter saturation voltage

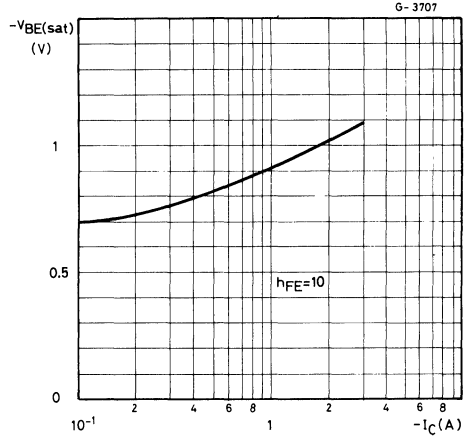

Saturated switching characteristics

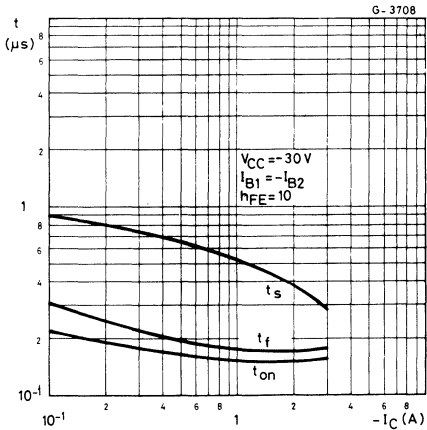

Power derating chart

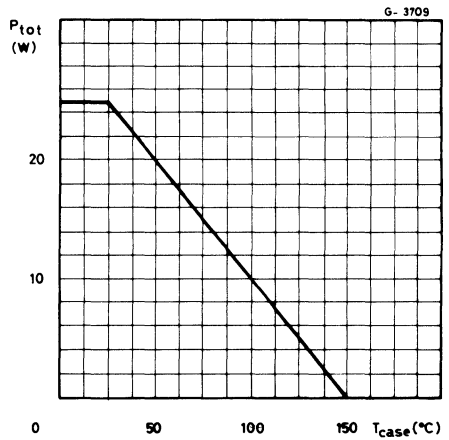

MEDIUM POWER LINEAR AND SWITCHING APPLICATIONS

The BD 239, BD 239A, BD 239B and BD 239C are silicon epitaxial-base NPN power transistors in Jedec TO-220 plastic package, intended for use in medium power linear and switching applications.

The complementary PNP types are BD 240, BD 240A, BD 240B and BD 240C respectively.

ABSOLUTE MAXIMUM RATINGS

		BD239	BD239A	BD239B	BD239C
V_{CER}	Collector-emitter voltage ($R_{BE} = 100\Omega$)	55V	70V	90V	115V
V_{CEO}	Collector-emitter voltage ($I_B = 0$)	45V	60V	80V	100V
V_{EBO}	Emitter-base voltage ($I_C = 0$)			5V	
I_C	Collector current			2A	
I_{CM}	Collector peak current			4A	
I_B	Base current			0.6A	
P_{tot}	Total power dissipation at $T_{case} \leq 25^\circ C$ $T_{amb} \leq 25^\circ C$			30W	
T_{stg}	Storage temperature			-65 to 150°C	
T_j	Junction temperature			150°C	

INTERNAL SCHEMATIC DIAGRAM

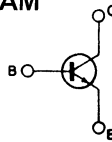

MECHANICAL DATA

Dimensions in mm

Collector connected to tab.

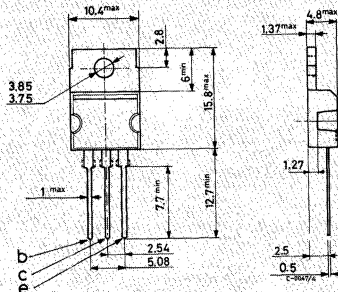

TO-220



THERMAL DATA

$R_{th\ j-case}$	Thermal resistance junction-case	max	4.17	°C/W
$R_{th\ j-amb}$	Thermal resistance junction-ambient	max	62.5	°C/W

ELECTRICAL CHARACTERISTICS ($T_{case} = 25^{\circ}C$ unless otherwise specified)

Parameter		Test conditions		Min.	Typ.	Max.	Unit
I_{CEO}	Collector cutoff current ($I_B = 0$)	for BD 239 and BD 239A $V_{CE} = 30V$				0.3	mA
		for BD 239B and BD 239C $V_{CE} = 60V$				0.3	mA
I_{CES}	Collector cutoff current ($V_{BE} = 0$)	for BD 239	$V_{CE} = 45V$			0.2	mA
		for BD 239A	$V_{CE} = 60V$			0.2	mA
		for BD 239B	$V_{CE} = 80V$			0.2	mA
		for BD 239C	$V_{CE} = 100V$			0.2	mA
I_{EBO}	Emitter cutoff current ($I_C = 0$)	$V_{EB} = 5V$				1	mA
$V_{CEO(sus)}$	*Collector-emitter sustaining voltage ($I_B = 0$)	$I_C = 30mA$ for BD 239 for BD 239A for BD 239B for BD 239C		45			V
				60			V
				80			V
				100			V
$V_{CE(sat)}$	* Collector-emitter saturation voltage	$I_C = 1A$	$I_B = 0.2A$			0.7	V
$V_{BE(on)}$	* Base-emitter voltage	$I_C = 1A$	$V_{CE} = 4V$			1.3	V
h_{FE}	* DC current gain	$I_C = 0.2A$	$V_{CE} = 4V$	40			—
		$I_C = 1A$	$V_{CE} = 4V$	15			—
h_{fe}	Small signal current gain	$I_C = 0.2A$	$V_{CE} = 10V$	20			—
		$f = 1KHz$ $I_C = 0.2A$ $f = 1MHz$	$V_{CE} = 10V$	3			—

* Pulsed: pulse duration = $300\mu s$, duty cycle $\leq 2\%$.



EPITAXIAL-BASE PNP

MEDIUM POWER LINEAR AND SWITCHING APPLICATIONS

The BD 240, BD 240A, BD 240B and BD 240C are silicon epitaxial-base PNP power transistors in Jedec TO-220 plastic package, intended for use in medium power linear and switching applications.

The complementary NPN types are BD 239, BD 239A, BD 239B and BD 239C respectively.

ABSOLUTE MAXIMUM RATINGS

		BD 240	BD 240A	BD 240B	BD 240C
V_{CER}	Collector-emitter voltage ($R_{BE} = 100\Omega$)	-55V	-70V	-90V	-115V
V_{CEO}	Collector-emitter voltage ($I_B = 0$)	-45V	-60V	-80V	-100V
V_{EBO}	Emitter-base voltage ($I_C = 0$)			-5V	
I_C	Collector current			-2A	
I_{CM}	Collector peak current			-4A	
I_B	Base current			-0.6A	
P_{tot}	Total power dissipation at $T_{case} \leq 25^\circ C$ $T_{amb} \leq 25^\circ C$			30W 2W	
T_{stg}	Storage temperature			-65 to 150°C	
T_j	Junction temperature			150°C	

INTERNAL SCHEMATIC DIAGRAM

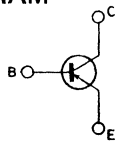

MECHANICAL DATA

Dimensions in mm

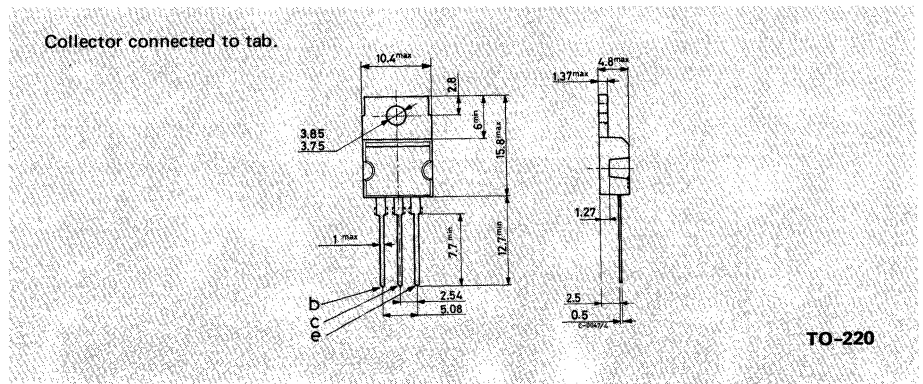

TO-220



THERMAL DATA

$R_{th\ j-case}$	Thermal resistance junction-case	max.	4.17	°C/W
$R_{th\ j-amb}$	Thermal resistance junction-ambient	max.	62.5	°C/W

ELECTRICAL CHARACTERISTICS ($T_{case} = 25^{\circ}C$ unless otherwise specified)

Parameter	Test conditions	Min.	Typ.	Max.	Unit
I_{CEO} Collector cutoff current ($I_B = 0$)	for BD240 and BD240A $V_{CE} = -30V$			-0.3	mA
	for BD240B and BD240C $V_{CE} = -60V$			-0.3	mA
I_{CES} Collector cutoff current ($V_{BE} = 0$)	for BD240 $V_{CE} = -45V$			-0.2	mA
	for BD240A $V_{CE} = -60V$			-0.2	mA
	for BD240B $V_{CE} = -80V$			-0.2	mA
	for BD240C $V_{CE} = -100V$			-0.2	mA
I_{EBO} Emitter cutoff current ($I_C = 0$)	$V_{EB} = -5V$			-1	mA
$V_{CEO(sus)}$ * Collector-emitter sustaining voltage ($I_B = 0$)	for BD240 $I_C = -30mA$	-45			V
	for BD240A	-60			V
	for BD240B	-80			V
	for BD240C	-100			V
$V_{CE(sat)}$ * Collector-emitter saturation voltage	$I_C = -1A$ $I_B = -0.2A$			-0.7	V
$V_{BE(on)}$ * Base-emitter voltage	$I_C = -1A$ $V_{CE} = -4V$			-1.3	V
h_{FE} * DC current gain	$I_C = -0.2A$ $V_{CE} = -4V$	40			—
	$I_C = -1A$ $V_{CE} = -4V$	15			—
h_{fe} Small signal current gain	$I_C = -0.2A$ $V_{CE} = -10V$ $f = 1KHz$	20			—
	$I_C = -0.2A$ $V_{CE} = -10V$ $f = 1MHz$	3			—

* Pulsed: pulse duration = 300 μs , duty cycle $\leq 2\%$.

Safe operating areas

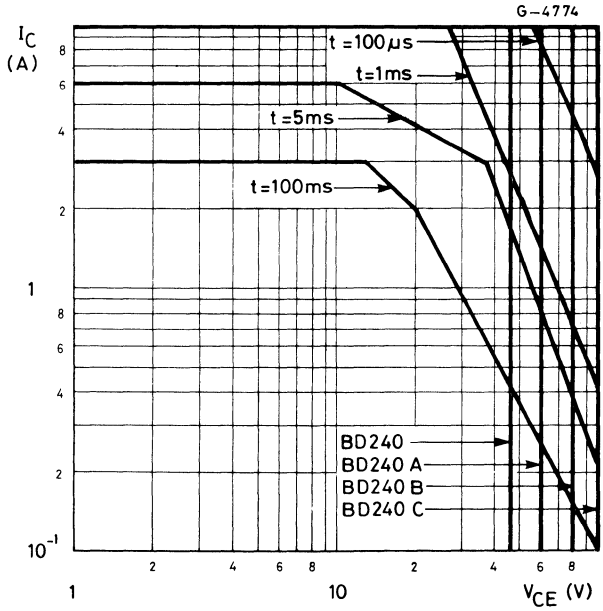

Collector cutoff current

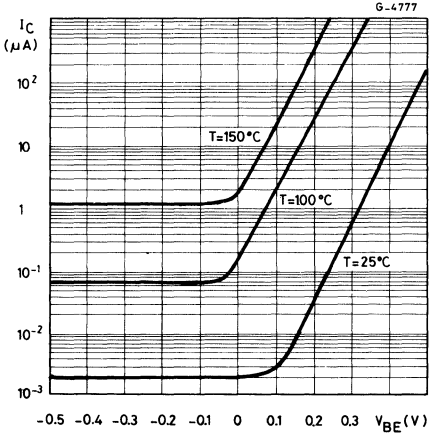

DC current gain

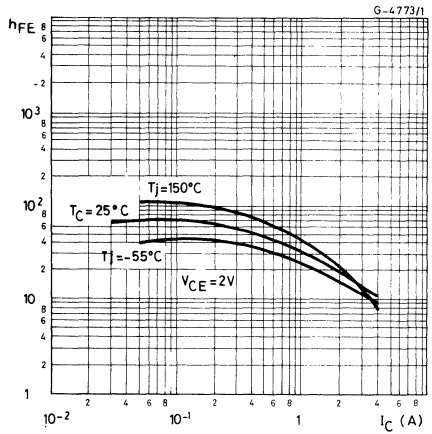



Input and output capacitance

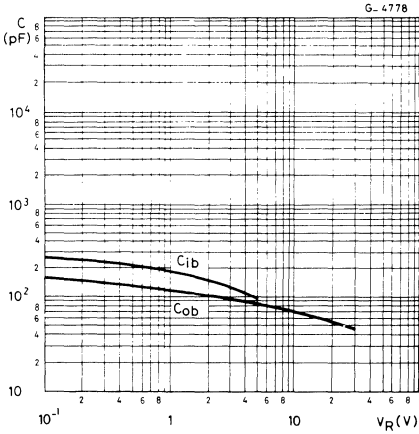

Base-emitter voltage

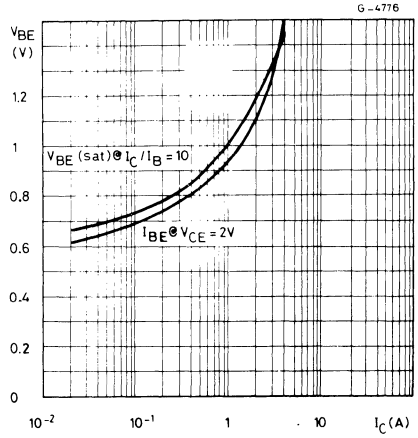

Collector-emitter saturation voltage

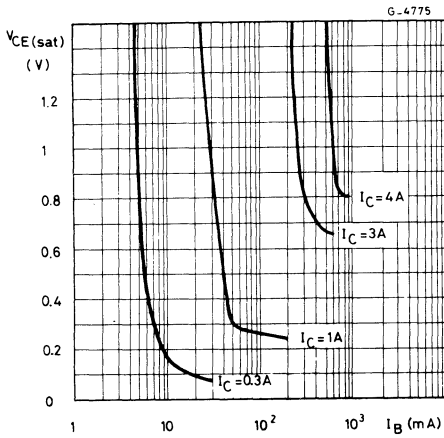

MEDIUM POWER LINEAR AND SWITCHING APPLICATIONS

The BD 241, BD 241A, BD 241B and BD 241C are silicon epitaxial-base NPN power transistors in Jedec TO-220 plastic package, intended for use in medium power linear and switching applications.

The complementary PNP types are the BD 242, BD 242A, BD 242B and BD 242C respectively.

ABSOLUTE MAXIMUM RATINGS

		BD241	BD241A	BD241B	BD241C
V_{CER}	Collector-emitter voltage ($R_{BE} = 100\Omega$)	55V	70V	90V	115V
V_{CEO}	Collector-emitter voltage ($I_B = 0$)	45V	60V	80V	100V
V_{EBO}	Emitter-base voltage ($I_C = 0$)			5V	
I_C	Collector current			3A	
I_{CM}	Collector peak current			5A	
I_B	Base-current			1A	
P_{tot}	Total power dissipation at $T_{case} \leq 25^\circ C$ $T_{amb} \leq 25^\circ C$			40W	
T_{stg}	Storage temperature			-65 to 150°C	
T_j	Junction temperature			150°C	

INTERNAL SCHEMATIC DIAGRAM

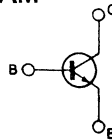

MECHANICAL DATA

Dimensions in mm

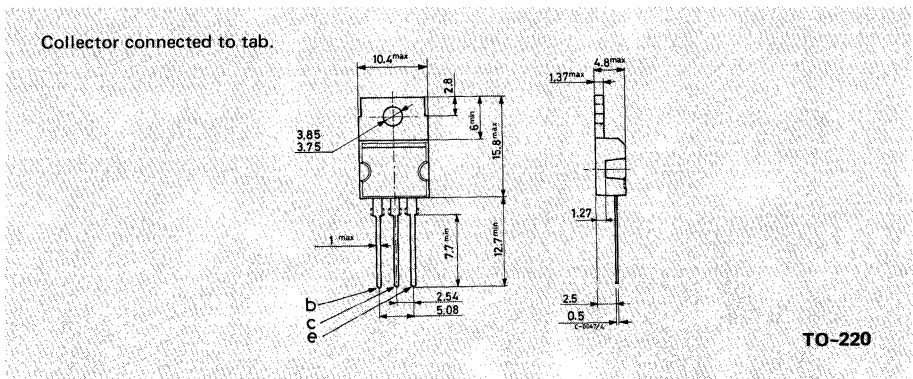



THERMAL DATA

$R_{th\ j-case}$	Thermal resistance junction-case	max 3.13 °C/W
$R_{th\ j-amb}$	Thermal resistance junction-ambient	max 62.5 °C/W

ELECTRICAL CHARACTERISTICS ($T_{case} = 25^{\circ}C$ unless otherwise specified)

Parameter	Test conditions	Min. Typ. Max.	Unit
I_{CEO} Collector cutoff current ($I_B = 0$)	for BD 241 and BD 241A $V_{CE} = 30V$	0.3	mA
	for BD 241B and BD 241C $V_{CE} = 60V$	0.3	mA
I_{CES} Collector cutoff current ($V_{BE} = 0$)	for BD 241 $V_{CE} = 45V$	0.2	mA
	for BD 241A $V_{CE} = 60V$	0.2	mA
	for BD 241B $V_{CE} = 80V$	0.2	mA
	for BD 241C $V_{CE} = 100V$	0.2	mA
I_{EBO} Emitter cutoff current ($I_C = 0$)	$V_{EB} = 5V$	1	mA
$V_{CEO(sus)}$ * Collector-emitter sustaining voltage ($I_B = 0$)	$I_C = 30mA$ for BD 241 for BD 241A for BD 241B for BD 241C	45 60 80 100	V V V V
$V_{CE(sat)}$ * Collector-emitter saturation voltage	$I_C = 3A$ $I_B = 0.6A$	1.2	V
$V_{BE(on)}$ * Base-emitter voltage	$I_C = 3A$ $V_{CE} = 4V$	1.8	V
h_{FE} * DC current gain	$I_C = 1A$ $V_{CE} = 4V$	25	—
	$I_C = 3A$ $V_{CE} = 4V$	10	—
h_{fe} Small signal current gain	$I_C = 0.5A$ $V_{CE} = 10V$ $f = 1KHz$	20	—
	$I_C = 0.5A$ $V_{CE} = 10V$ $f = 1MHz$	3	—

* Pulsed: pulse duration = 300 μs , duty cycle $\leq 2\%$.



BD242
BD242A
BD242B
BD242C

EPITAXIAL-BASE PNP

MEDIUM POWER LINEAR AND SWITCHING APPLICATIONS

The BD 242, BD 242A, BD 242B and BD 242C are silicon epitaxial-base PNP power transistors in Jedec TO-220 plastic package, intended for use in medium power linear and switching applications.

The complementary NPN types are the BD 241, BD 241A, BD 241B and BD 241C respectively.

ABSOLUTE MAXIMUM RATINGS

		BD242	BD242A	BD242B	BD242C
V_{CER}	Collector-emitter voltage ($R_{BE} = 100\Omega$)	-55V	-70V	-90V	-115V
V_{CEO}	Collector-emitter voltage ($I_B = 0$)	-45V	-60V	-80V	-100V
V_{EBO}	Emitter-base voltage ($I_C = 0$)			-5V	
I_C	Collector current			-3A	
I_{CM}	Collector peak current			-5A	
I_B	Base-current			-1A	
P_{tot}	Total power dissipation at $T_{case} \leq 25^\circ C$ $T_{amb} \leq 25^\circ C$			40W 2W	
T_{stg}	Storage temperature			-65 to 150°C	
T_j	Junction temperature			150°C	

INTERNAL SCHEMATIC DIAGRAM

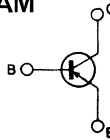

MECHANICAL DATA

Dimensions in mm

Collector connected to tab.

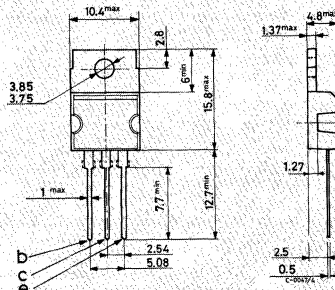

TO-220



THERMAL DATA

$R_{th\ j-case}$	Thermal resistance junction-case	max	3.13	°C/W
$R_{th\ j-amb}$	Thermal resistance junction-ambient	max	62.5	°C/W

ELECTRICAL CHARACTERISTICS ($T_{case} = 25^{\circ}C$ unless otherwise specified)

Parameter	Test conditions	Min.	Typ.	Max.	Unit
I_{CEO}	Collector cutoff current ($I_B = 0$) for BD 242 and BD 242A $V_{CE} = -30V$ for BD 242B and BD 242C $V_{CE} = -60V$			-0.3 -0.3	 mA mA
I_{CES}	Collector cutoff current ($V_{BE} = 0$) for BD 242 for BD 242A for BD 242B for BD 242C	$V_{CE} = -45V$ $V_{CE} = -60V$ $V_{CE} = -80V$ $V_{CE} = -100V$		-0.2 -0.2 -0.2 -0.2	 mA mA mA mA
I_{EBO}	Emitter cutoff current ($I_C = 0$)	$V_{EB} = -5V$		-1	 mA
$V_{CEO(sus)}$ *	Collector-emitter sustaining voltage ($I_B = 0$)	$I_C = -30mA$ for BD 242 for BD 242A for BD 242B for BD 242C		-45 -60 -80 -100	 V V V V
$V_{CE(sat)}$ *	Collector-emitter saturation voltage	$I_C = -3A$ $I_B = -0.6A$		-1.2	 V
V_{BE} *	Base-emitter voltage	$I_C = -3A$ $V_{CE} = -4V$		-1.8	 V
h_{FE} *	DC current gain	$I_C = -1A$ $V_{CE} = -4V$ $I_C = -3A$ $V_{CE} = -4V$		25 10	 — —
h_{fe}	Small signal current gain	$I_C = -0.5A$ $V_{CE} = -10V$ $f = 1KHz$ $I_C = -0.5A$ $V_{CE} = -10V$ $f = 1MHz$		20 3	 — —

* Pulsed: pulse duration = 300 μ s, duty cycle \leq 2%.



THERMAL DATA

$R_{th\ j-case}$	Thermal resistance junction-case	max	1.92	°C/W
$R_{th\ j-amb}$	Thermal resistance junction-ambient	max	62.5	°C/W

ELECTRICAL CHARACTERISTICS ($T_{case} = 25^{\circ}C$ unless otherwise specified)

Parameter		Test conditions		Min.	Typ.	Max.	Unit
I_{CEO}	Collector cutoff current ($I_B = 0$)	for BD 243 and BD 243A				0.7	mA
		$V_{CE} = 30V$					
I_{CES}	Collector cutoff current ($V_{BE} = 0$)	for BD 243B and BD 243C				0.7	mA
		$V_{CE} = 60V$					
I_{CEO}	Collector-emitter sustaining voltage ($I_B = 0$)	$I_C = 30mA$	for BD 243	$V_{CE} = 45V$		0.4	mA
			for BD 243A	$V_{CE} = 60V$		0.4	mA
			for BD 243B	$V_{CE} = 80V$		0.4	mA
			for BD 243C	$V_{CE} = 100V$		0.4	mA
I_{EBO}	Emitter cutoff current ($I_C = 0$)	$V_{EB} = 5V$				1	mA
$V_{CEO(sus)}$	Collector-emitter sustaining voltage ($I_B = 0$)	$I_C = 30mA$		45			V
		for BD 243A		60			V
		for BD 243B		80			V
		for BD 243C		100			V
$V_{CE(sat)}$	Collector-emitter saturation voltage	$I_C = 6A$	$I_B = 1A$			1.5	V
V_{BE}	Base-emitter voltage	$I_C = 6A$	$V_{CE} = 4V$			2	V
h_{FE}	DC current gain	$I_C = 0.3A$	$V_{CE} = 4V$	30			—
		$I_C = 3A$	$V_{CE} = 4V$	15			—
h_{fe}	Small signal current gain	$I_C = 0.5A$	$V_{CE} = 10V$	20			—
		$f = 1KHz$					
		$I_C = 0.50$	$V_{CE} = 10V$	3			—
		$f = 1MHz$					—

* Pulsed: pulse duration = 300 μ s, duty cycle \leq 2%.



BD244
BD244A
BD244B
BD244C

EPITAXIAL-BASE PNP

POWER LINEAR AND SWITCHING APPLICATIONS

The BD 244, BD 244A, BD 244B and BD 244C are silicon epitaxial-base PNP power transistors in Jedec TO-220 plastic package intended for use in medium power linear and switching applications.

The complementary NPN types are the BD 243, BD 243A, BD 243B and BD 243C respectively.

ABSOLUTE MAXIMUM RATINGS

	BD244	BD244A	BD244B	BD244C	
V_{CBO}	Collector-base voltage ($I_E = 0$)	-45V	-60V	-80V	-100V
V_{CEO}	Collector-emitter voltage ($I_B = 0$)	-45V	-60V	-80V	-100V
V_{EBO}	Emitter-base voltage ($I_C = 0$)		-5V		
I_C	Collector current		-6A		
I_{CM}	Collector peak current		-10A		
I_B	Base current		-2A		
P_{tot}	Total power dissipation at $T_{case} \leq 25^\circ C$		65W		
T_{stg}	Storage temperature		-65 to 150°C		
T_j	Junction temperature		150°C		

INTERNAL SCHEMATIC DIAGRAM

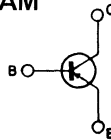

MECHANICAL DATA

Dimensions in mm

Collector connected to tab.

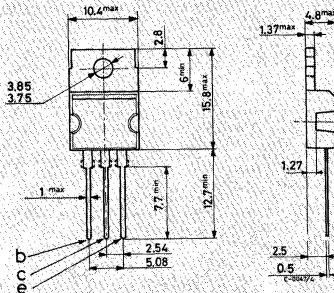

TO-220



THERMAL DATA

$R_{th\ j-case}$	Thermal resistance junction-case	max	1.92	°C/W
$R_{th\ j-amb.}$	Thermal resistance junction-ambient	max	62.5	°C/W

ELECTRICAL CHARACTERISTICS ($T_{case} = 25^{\circ}C$ unless otherwise specified)

Parameter		Test conditions		Min.	Typ.	Max.	Unit
I_{CEO}	Collector cutoff current ($I_B = 0$)	for BD 244 and BD 244A $V_{CE} = -30V$ for BD 244B and BD 244C $V_{CE} = -60V$				-0.7	mA
						-0.7	mA
I_{CES}	Collector cutoff current ($V_{BE} = 0$)	for BD 244 for BD 244A for BD 244B for BD 244C	$V_{CE} = -45V$ $V_{CE} = -60V$ $V_{CE} = -80V$ $V_{CE} = -100V$			-0.4	mA
						-0.4	mA
						-0.4	mA
						-0.4	mA
I_{EBO}	Emitter cutoff current ($I_C = 0$)	$V_{EB} = -5V$				-1	mA
$V_{CEO(sus)}$	*Collector-emitter sustaining voltage ($I_B = 0$)	$I_C = -30mA$ for BD 244 for BD 244A for BD 244B for BD 244C				-45 -60 -80 -100	V V V V
$V_{CE(sat)}$	*Collector-emitter saturation voltage	$I_C = -6A$	$I_B = -1A$			-1.5	V
V_{BE}	*Base-emitter voltage	$I_C = -6A$	$V_{CE} = -4V$			-2	V
h_{FE}	*DC current gain	$I_C = -0.3A$ $I_C = -3A$	$V_{CE} = -4V$ $V_{CE} = -4V$			30 15	
h_{fe}	*Small signal current gain	$I_C = -0.5A$ $I_C = -0.5A$	$V_{CE} = -10V$ $V_{CE} = -10V$			20 3	
			$f = 1KHz$ $f = 1MHz$				

* Pulsed: pulse duration = 300 μ s, duty cycle \leq 2%



EPITAXIAL-BASE NPN

MEDIUM POWER LINEAR AND SWITCHING APPLICATIONS

The BD 433, BD 435 and BD 437 are silicon epitaxial-base NPN power transistors in Jedec TO-126 plastic package, intended for use in medium power linear and switching applications.

The BD 433 is especially suitable for use in car-radio output stages.

The complementary PNP types are the BD 434, BD 436 and BD 438 respectively.

ABSOLUTE MAXIMUM RATINGS

		BD 433	BD 435	BD 437
V_{CBO}	Collector-base voltage ($I_E = 0$)	22V	32V	45V
V_{CES}	Collector-emitter voltage ($V_{BE} = 0$)	22V	32V	45V
V_{CEO}	Collector-emitter voltage ($I_B = 0$)	22V	32V	45V
V_{EBO}	Emitter-base voltage ($I_C = 0$)		5V	
I_C	Collector current		4A	
I_{CM}	Collector peak current ($t \leq 10ms$)		7A	
I_B	Base current		1A	
P_{tot}	Total power dissipation at $T_{case} \leq 25^\circ C$		36 W	
T_{stg}	Storage temperature		-65 to 150°C	
T_j	Junction temperature		150°C	

INTERNAL SCHEMATIC DIAGRAM

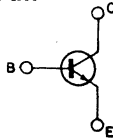

MECHANICAL DATA

Dimensions in mm

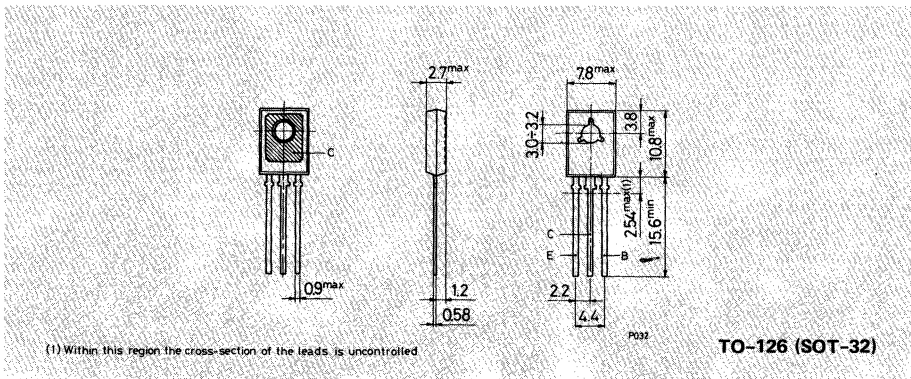

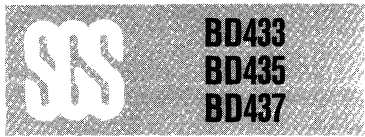

THERMAL DATA

$R_{th\ j-case}$	Thermal resistance junction-case	max	3.5	°C/W
$R_{th\ j-amb}$	Thermal resistance junction-ambient	max	100	°C/W

ELECTRICAL CHARACTERISTICS ($T_{case} = 25^{\circ}C$ unless otherwise specified)

Parameter	Test conditions	Min.	Typ.	Max.	Unit
I_{CBO}	Collector cutoff current ($I_E = 0$) for BD433 $V_{CB} = 22V$ for BD435 $V_{CB} = 32V$ for BD437 $V_{CB} = 45V$			100	μA
I_{CES}	Collector cutoff current ($V_{BE} = 0$) for BD433 $V_{CE} = 22V$ for BD435 $V_{CE} = 32V$ for BD437 $V_{CE} = 45V$			100	μA
I_{EBO}	Emitter cutoff current ($I_C = 0$) $V_{EB} = 5V$			1	mA
$V_{CEO(sus)}$ * Collector-emitter sustaining voltage ($I_B = 0$)	$I_C = 100mA$ for BD433 for BD435 for BD437	22		45	V
$V_{CE(sat)}$ * Collector-emitter saturation voltage	$I_C = 2A$ $I_B = 0.2A$ for BD433 for BD435 for BD437	0.2	0.5	0.6	V
V_{BE} * Base-emitter voltage	$I_C = 10\ mA$ $V_{CE} = 5V$ $I_C = 2\ A$ $V_{CE} = 1V$ for BD433 for BD435 for BD437	0.58		1.2	V
h_{FE} * DC current gain	$I_C = 10\ mA$ $V_{CE} = 5V$ for BD433 for BD435 for BD437 $I_C = 500mA$ $V_{CE} = 1V$ $I_C = 2\ A$ $V_{CE} = 1V$ for BD433 for BD435 for BD437	40	130		—
h_{FE1}/h_{FE2} * Matched pair	$I_C = 500mA$ $V_{CE} = 1V$		1.4		—
f_T Transition frequency	$I_C = 250mA$ $V_{CE} = 1V$	3			MHz

* Pulsed: pulse duration = 300 μs , duty cycle = 1.5%

Safe operating areas

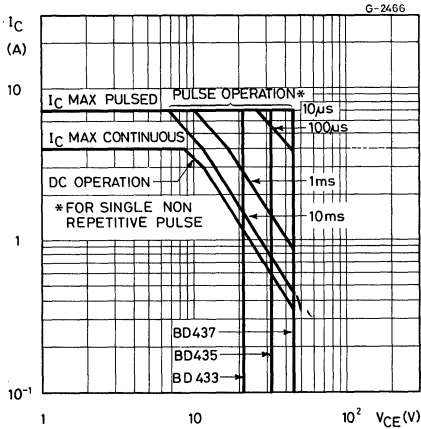

DC current gain

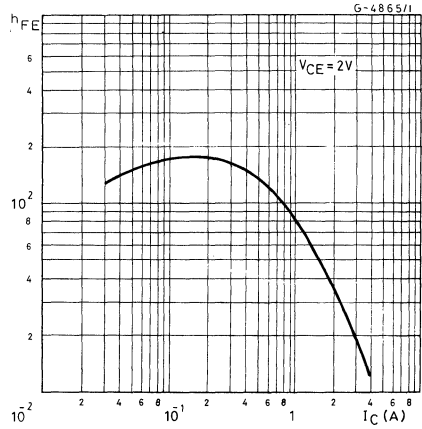

DC transconductance

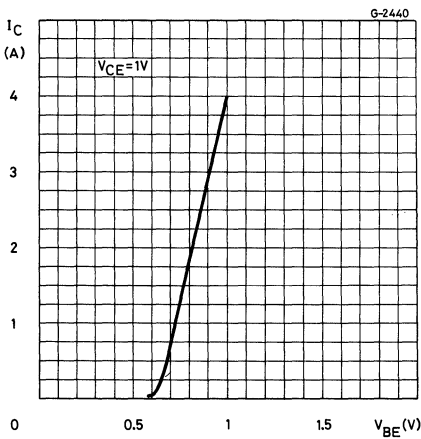

Collector-emitter saturation voltage

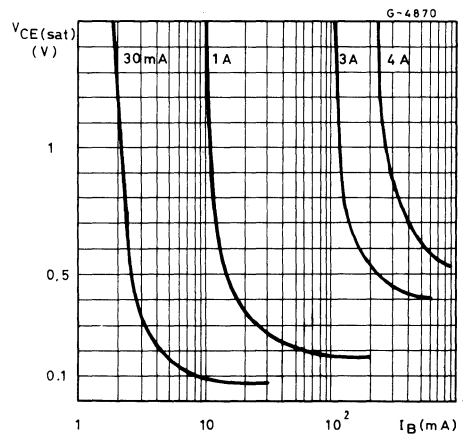

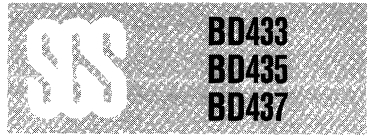

Transition frequency

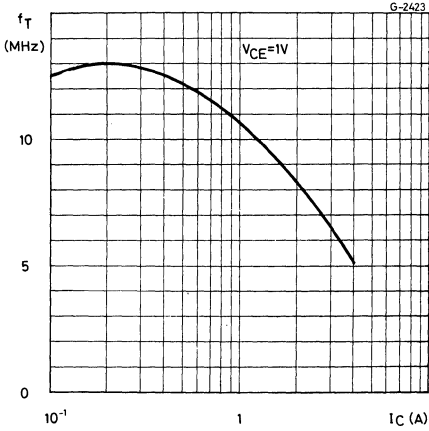

Collector-base capacitance

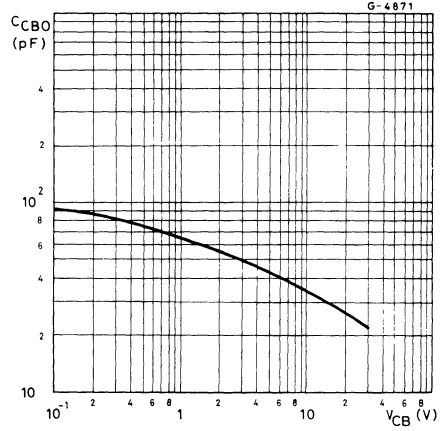

Saturated switching characteristics

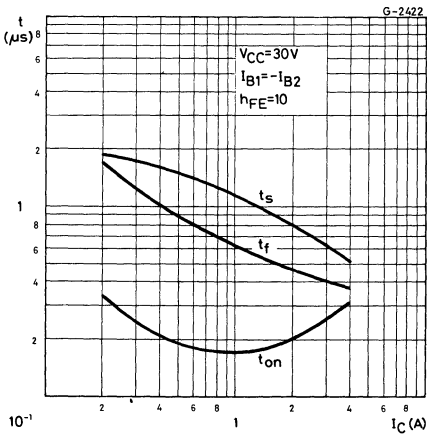

Power rating chart

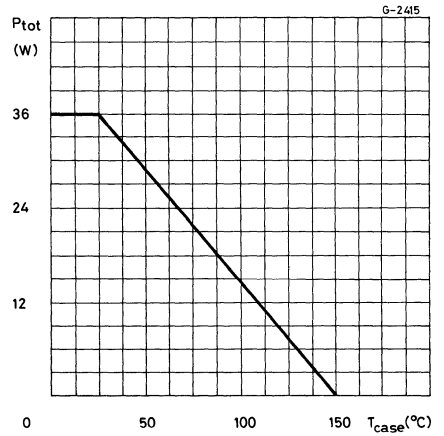



**BD434
BD436
BD438**

EPITAXIAL-BASE PNP

MEDIUM POWER LINEAR AND SWITCHING APPLICATIONS

The BD 434, BD 436 and BD 438 are silicon epitaxial-base PNP power transistors in Jedec TO-126 plastic package, intended for use in medium power linear and switching applications.

The BD 434 is especially suitable for use in car-radio output stages.

The complementary NPN types are the BD 433, BD 435 and BD 437 respectively.

ABSOLUTE MAXIMUM RATINGS

		BD 434	BD 436	BD 438
V_{CB0}	Collector-base voltage ($I_E = 0$)	-22V	-32V	-45V
V_{CES}	Collector-emitter voltage ($V_{BE} = 0$)	-22V	-32V	-45V
V_{CEO}	Collector-emitter voltage ($I_B = 0$)	-22V	-32V	-45V
V_{EBO}	Emitter-base voltage ($I_C = 0$)		-5V	
I_C	Collector current		-4A	
I_{CM}	Collector peak current ($t \leq 10ms$)		-7A	
I_B	Base current		-1A	
P_{tot}	Total power dissipation at $T_{case} \leq 25^\circ C$		36 W	
T_{stg}	Storage temperature		-65 to $150^\circ C$	
T_j	Junction temperature		$150^\circ C$	

INTERNAL SCHEMATIC DIAGRAM

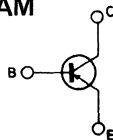

MECHANICAL DATA

Dimensions in mm

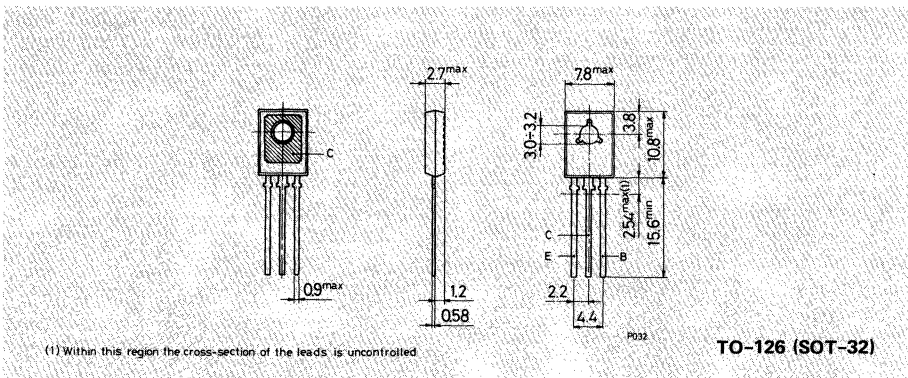



THERMAL DATA

$R_{th\ j-case}$	Thermal resistance junction-case	max	3.5	°C/W
$R_{th\ j-amb}$	Thermal resistance junction-ambient	max	100	°C/W

ELECTRICAL CHARACTERISTICS ($T_{case} = 25^{\circ}C$ unless otherwise specified)

Parameter	Test conditions	Min.	Typ.	Max.	Unit
I_{CBO}	Collector cutoff current ($I_E = 0$). for BD434 $V_{CB} = -22V$ for BD436 $V_{CB} = -32V$ for BD438 $V_{CB} = -45V$			-100 -100 -100	μA μA μA
I_{CES}	Collector cutoff current ($V_{BE} = 0$) for BD434 $V_{CE} = -22V$ for BD436 $V_{CE} = -32V$ for BD438 $V_{CE} = -45V$			-100 -100 -100	μA μA μA
I_{EBO}	Emitter cutoff current ($I_C = 0$) $V_{EB} = -5V$			-1	mA
$V_{CEO(sus)}^*$	Collector-emitter sustaining voltage ($I_B = 0$) $I_C = -100mA$ for BD434 for BD436 for BD438	-22 -32 -45			V V V
$V_{CE(sat)}^*$	Collector-emitter saturation voltage $I_C = -2A$ $I_B = -0.2A$ for BD434 for BD436 for BD438	-0.2 -0.2 -0.2		-0.5 -0.5 -0.6	V V V
V_{BE}^*	Base-emitter voltage $I_C = -10\ mA$ $V_{CE} = -5V$ $I_C = -2\ A$ $V_{CE} = -1\ V$ for BD434 for BD436 for BD438	-0.58		-1.1 -1.1 -1.2	V V V
h_{FE}^*	DC current gain $I_C = -10mA$ $V_{CE} = -5V$ for BD434 for BD436 for BD438 $I_C = -500mA$ $V_{CE} = -1V$ $I_C = -2\ A$ $V_{CE} = -1V$ for BD434 for BD436 for BD438	40 40 30 85 50 50 40	140 140 140 140		— — — — — — —
h_{FE1}/h_{FE2}^*	Matched pair $I_C = -500mA$ $V_{CE} = -1V$			1.4	—
f_T	Transition frequency $I_C = -250mA$ $V_{CE} = -1V$	3			MHz

* Pulsed: pulse duration = 300 μs , duty cycle = 1.5%

Safe operating areas

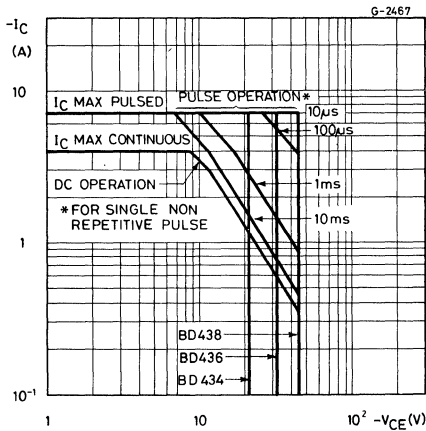

DC current gain

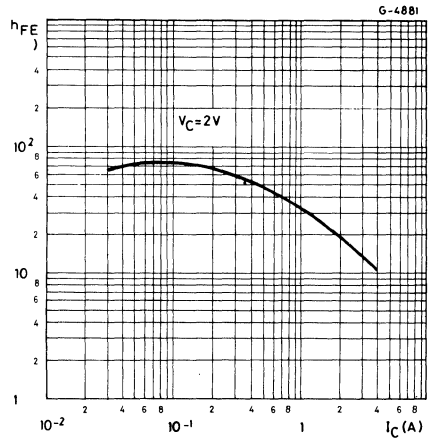

DC transconductance

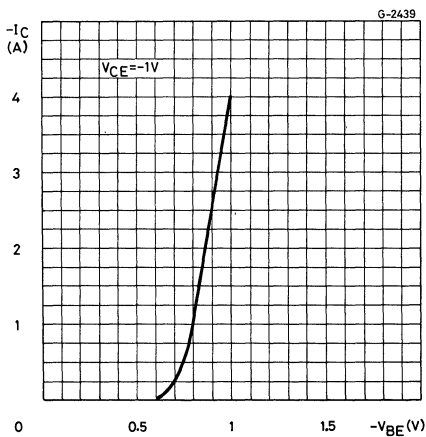

Collector-emitter saturation voltage

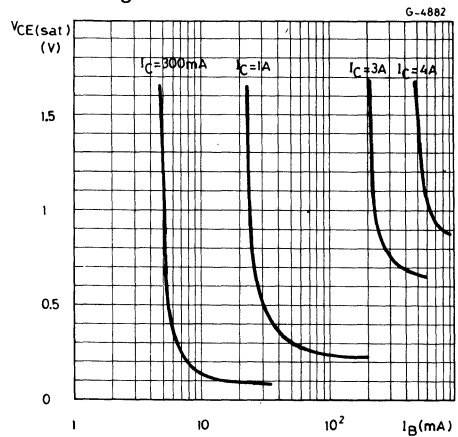



Transition frequency

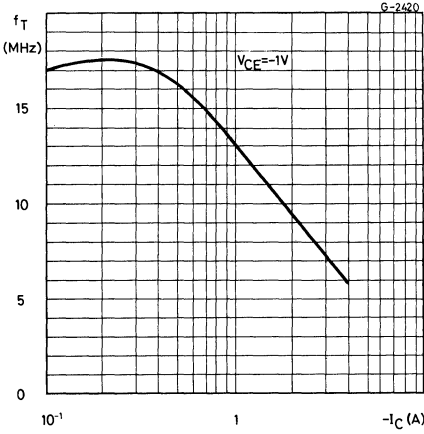

Collector-base capacitance

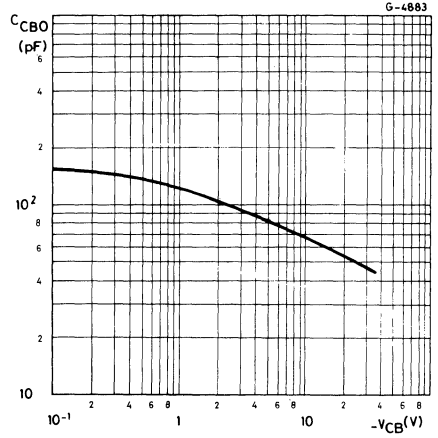

Saturated switching characteristics

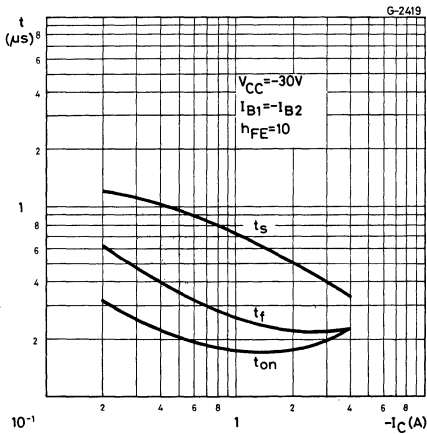

Power rating chart

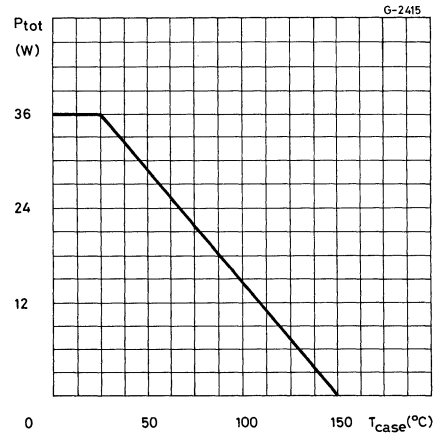



BD439
BD441

EPITAXIAL-BASE NPN

MEDIUM POWER LINEAR AND SWITCHING APPLICATIONS

The BD 439 and BD 441 are silicon epitaxial-base NPN power transistors in Jedec TO-126 plastic package, intended for use in power linear and switching applications. The complementary PNP types are the BD 440 and BD 442 respectively.

ABSOLUTE MAXIMUM RATINGS

	BD 439	BD 441
V_{CBO}	60V	80V
V_{CES}	60V	80V
V_{CEO}	60V	80V
V_{EBO}		5V
I_C		4A
I_{CM}		7A
I_B		1A
P_{tot}		36 W
T_{stg}		-65 to 150°C
T_j		150°C

INTERNAL SCHEMATIC DIAGRAM

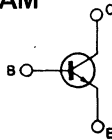

MECHANICAL DATA

Dimensions in mm

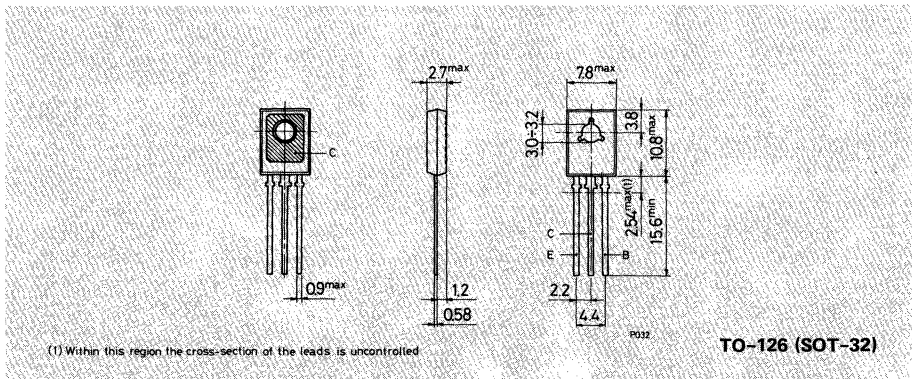



BD439
BD441

THERMAL DATA

$R_{th\ j-case}$	Thermal resistance junction-case	max	3.5	°C/W
$R_{th\ j-amb}$	Thermal resistance junction-ambient	max	100	°C/W

ELECTRICAL CHARACTERISTICS ($T_{case} = 25^{\circ}C$ unless otherwise specified)

Parameter	Test conditions	Min.	Typ.	Max.	Unit
I_{CBO}	Collector cutoff current ($I_E = 0$)	for BD439 for BD441	$V_{CB} = 60V$ $V_{CB} = 80V$	100 100	μA μA
I_{CES}	Collector cutoff current ($V_{BE} = 0$)	for BD439 for BD441	$V_{CE} = 60V$ $V_{CE} = 80V$	100 100	μA μA
I_{EBO}	Emitter cutoff current ($I_C = 0$)	$V_{EB} = 5V$		1	mA
$V_{CEO(sus)}$ *	Collector-emitter sustaining voltage ($I_B = 0$)	$I_C = 100mA$	for BD 439 for BD 441	60 80	V V
$V_{CE(sat)}$ *	Collector-emitter saturation voltage	$I_C = 2A$	$I_B = 0.2A$	0.8	V
V_{BE} *	Base-emitter voltage	$I_C = 10 mA$ $I_C = 2 A$	$V_{CE} = 5V$ $V_{CE} = 1V$	0.58 1.5	V V
h_{FE} *	DC current gain	$I_C = 10 mA$ $I_C = 500mA$ $I_C = 2 A$	$V_{CE} = 5V$ for BD 439 for BD 441 $V_{CE} = 1V$ for BD 439 for BD 441 $V_{CE} = 1V$ for BD 439 for BD 441	20 130 15 130 40 140 40 140 25 15	— — — — — —
h_{FE1}/h_{FE2} *	Matched pair	$I_C = 500mA$	$V_{CE} = 1V$	1.4	—
f_T	Transition frequency	$I_C = 250mA$	$V_{CE} = 1V$	3	MHz

* Pulsed: pulse duration = 300 μs , duty cycle = 1.5%



BD439
BD441

Safe operating areas

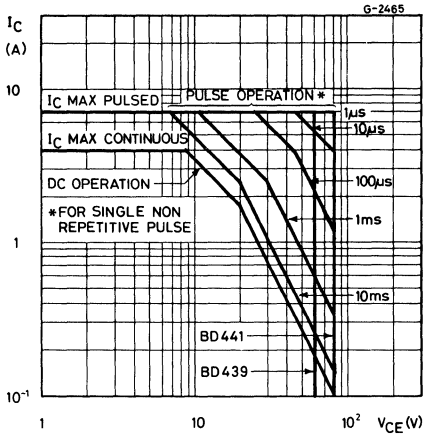

DC current gain

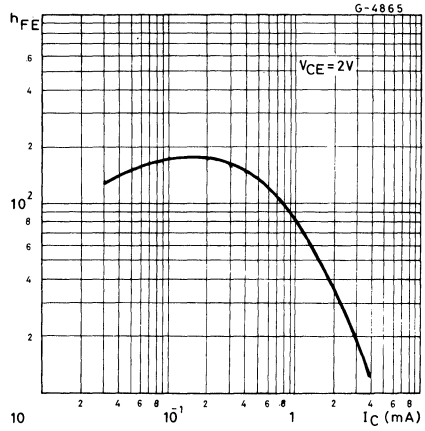

DC transconductance

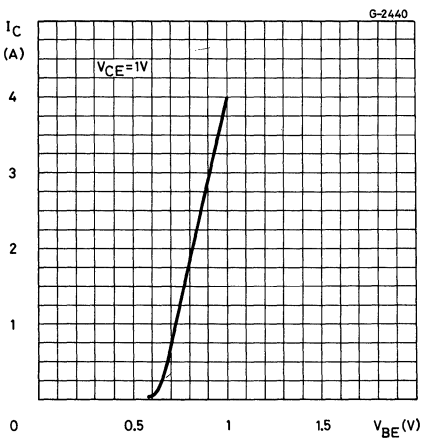

Collector-emitter saturation voltage

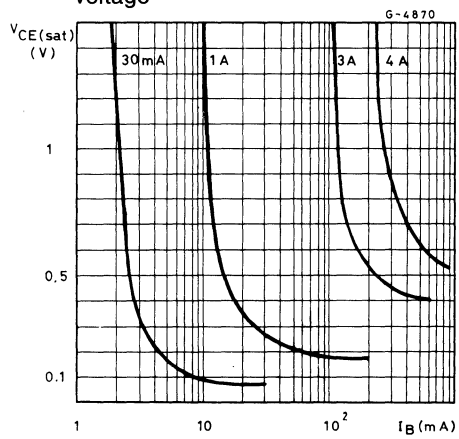



Transition frequency

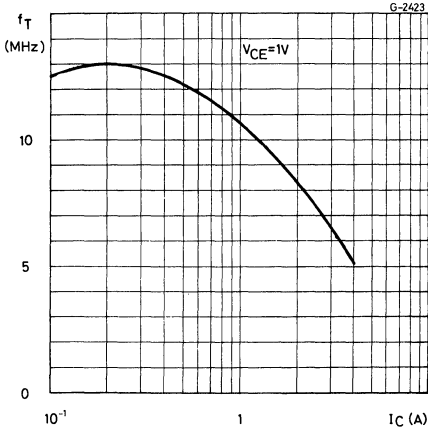

Collector-base capacitance

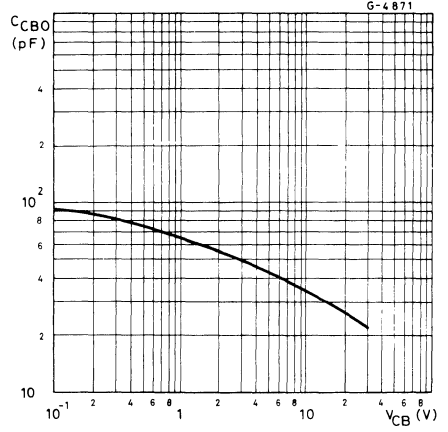

Saturated switching characteristics

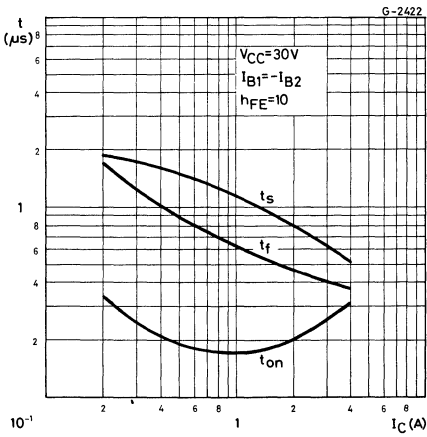

Power rating chart

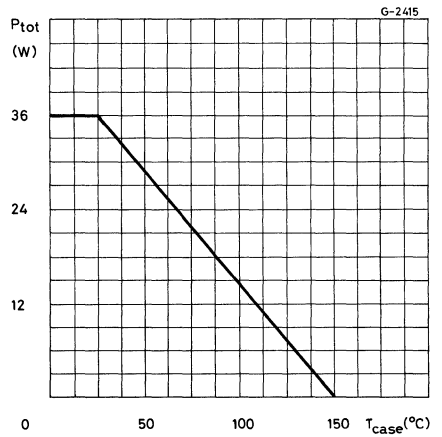



BD440
BD442

EPITAXIAL-BASE PNP

MEDIUM POWER LINEAR AND SWITCHING APPLICATIONS

The BD 440 and BD 442 are silicon epitaxial-base PNP power transistors in Jedec TO-126 plastic package intended for use in power linear and switching applications. The complementary NPN types are the BD439 and BD441 respectively.

ABSOLUTE MAXIMUM RATINGS

		BD 440	BD 442
V_{CBO}	Collector-base voltage ($I_E = 0$)	-60V	-80V
V_{CES}	Collector-emitter voltage ($V_{BE} = 0$)	-60V	-80V
V_{CEO}	Collector-emitter voltage ($I_B = 0$)	-60V	-80V
V_{EBO}	Emitter-base voltage ($I_C = 0$)		-5V
I_C	Collector current		-4A
I_{CM}	Collector peak current ($t \leq 10ms$)		-7A
I_B	Base current		-1A
P_{tot}	Total power dissipation at $T_{case} \leq 25^\circ C$		36 W
T_{stg}	Storage temperature		-65 to 150°C
T_j	Junction temperature		150°C

INTERNAL SCHEMATIC DIAGRAM

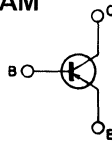

MECHANICAL DATA

Dimensions in mm

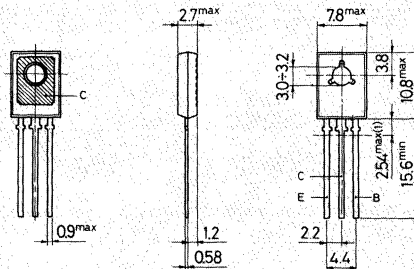

(1) Within this region the cross-section of the leads is uncontrolled

PO32

TO-126 (SOT-32)



BD440
BD442

THERMAL DATA

$R_{th\ j-case}$	Thermal resistance junction-case	max	3.5	°C/W
$R_{th\ j-amb}$	Thermal resistance junction-ambient	max	100	°C/W

ELECTRICAL CHARACTERISTICS ($T_{case} = 25^{\circ}C$ unless otherwise specified)

Parameter	Test conditions	Min.	Typ.	Max.	Unit
I_{CBO}	Collector cutoff current ($I_E = 0$) for BD440 $V_{CB} = -60V$ for BD442 $V_{CB} = -80V$			-100 -100	μA μA
I_{CES}	Collector cutoff current ($V_{BE} = 0$) for BD440 $V_{CE} = -60V$ for BD442 $V_{CE} = -80V$			-100 -100	μA μA
I_{EBO}	Emitter cutoff current ($I_C = 0$) $V_{EB} = -5V$			-1	mA
$V_{CEO(sus)}^*$	Collector-emitter sustaining voltage ($I_B = 0$) $I_C = -100mA$ for BD 440 for BD 442	-60 -80			V V
$V_{CE(sat)}^*$	Collector-emitter saturation voltage $I_C = -2A$ $I_B = -0.2A$			-0.8	V
V_{BE}^*	Base-emitter voltage $I_C = -10mA$ $V_{CE} = -5V$ $I_C = -2 A$ $V_{CE} = -1V$		-0.58	-1.5	V V
h_{FE}^*	DC current gain $I_C = -10mA$ $V_{CE} = -5V$ for BD 440 for BD 442 $I_C = -500mA$ $V_{CE} = -1V$ for BD 440 for BD 442 $I_C = -2 A$ $V_{CE} = -1V$ for BD 440 for BD 442	20 15	140 140		— — — — — —
h_{FE1}/h_{FE2}^*	Matched pair $I_C = -500mA$ $V_{CE} = -1V$			1.4	—
f_T	Transition frequency $I_C = -250mA$ $V_{CE} = -1V$			3	MHZ

* Pulsed: pulse duration = 300 μs , duty cycle = 1.5%



BD440
BD442

Safe operating areas

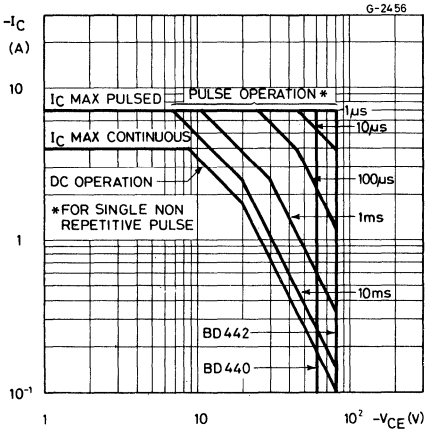

DC current gain

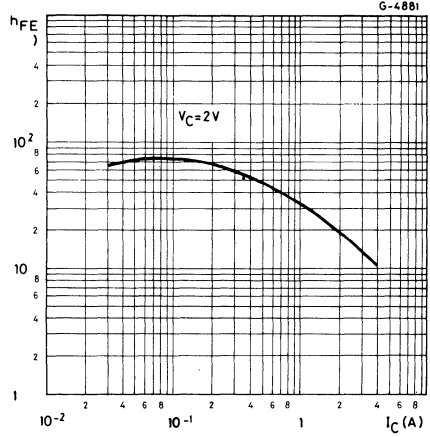

DC transconductance

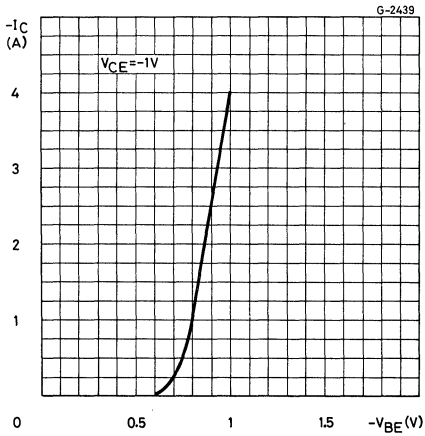

Collector-emitter saturation voltage

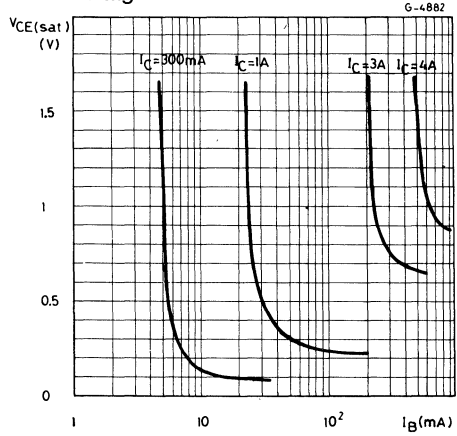



Transition frequency

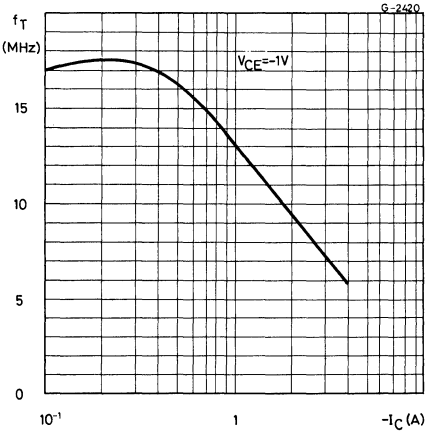

Collector-base capacitance

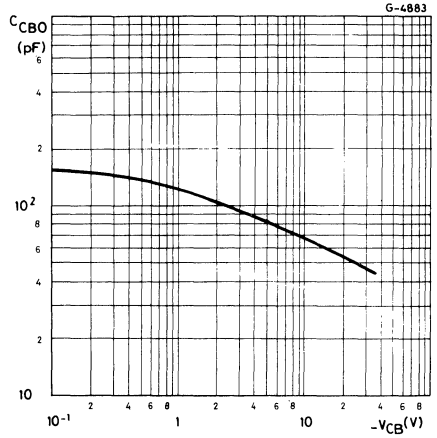

Saturated switching characteristics

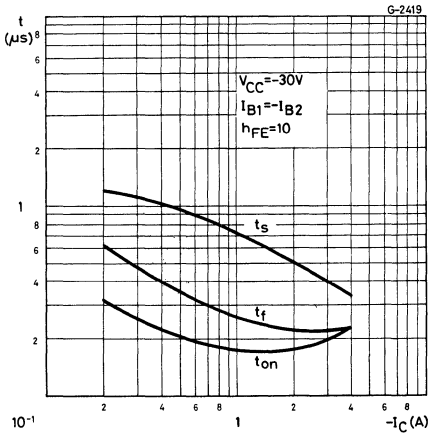

Power rating chart

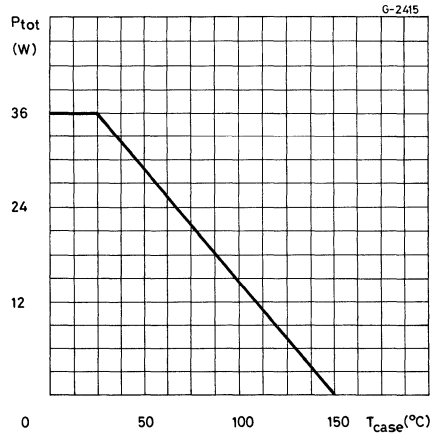

MEDIUM POWER LINEAR AND SWITCHING APPLICATIONS

The BD 533, BD 535 and BD 537 are silicon epitaxial-base NPN power transistors in Jedec TO-220 plastic package, intended for use in medium power linear and switching applications.

The complementary PNP types are the BD 534, BD 536 and BD 538 respectively.

ABSOLUTE MAXIMUM RATINGS

		BD 533	BD 535	BD 537
V_{CBO}	Collector-base voltage ($I_E = 0$)	45V	60V	80V
V_{CES}	Collector-emitter voltage ($V_{BE} = 0$)	45V	60V	80V
V_{CEO}	Collector-emitter voltage ($I_B = 0$)	45V	60V	80V
V_{EBO}	Emitter-base voltage ($I_C = 0$)		5V	
I_C, I_E	Collector and emitter current		8A	
I_B	Base current		1A	
P_{tot}	Total power dissipation at $T_{case} \leq 25^\circ C$		50 W	
T_{stg}	Storage temperature		-65 to 150°C	
T_j	Junction temperature		150°C	

INTERNAL SCHEMATIC DIAGRAM

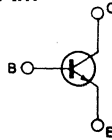

MECHANICAL DATA

Dimensions in mm

Collector connected to tab.

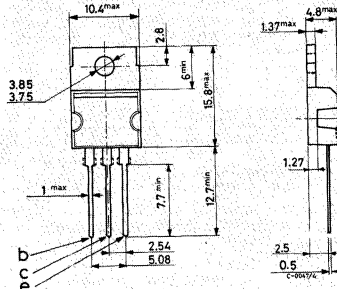

TO-220

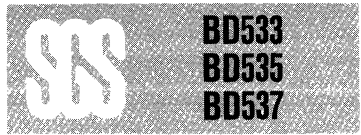

THERMAL DATA

$R_{th\ j-case}$	Thermal resistance junction-case	max	2.5	°C/W
$R_{th\ j-amb}$	Thermal resistance junction-ambient	max	70	°C/W

ELECTRICAL CHARACTERISTICS ($T_{case} = 25^{\circ}C$ unless otherwise specified)

Parameter	Test conditions	Min.	Typ.	Max.	Unit
I_{CBO}	Collector cutoff current ($I_E = 0$) for BD533 $V_{CB} = 45V$ for BD535 $V_{CB} = 60V$ for BD537 $V_{CB} = 80V$		100	100	μA
I_{CES}	Collector cutoff current ($V_{BE} = 0$) for BD533 $V_{CE} = 45V$ for BD535 $V_{CE} = 60V$ for BD537 $V_{CE} = 80V$		100	100	μA
I_{EBO}	Emitter cutoff current ($I_C = 0$) $V_{EB} = 5V$			1	mA
$V_{CEO(sus)}^*$	Collector-emitter sustaining voltage ($I_B = 0$) $I_C = 100mA$ for BD533 for BD535 for BD537	45		80	V
$V_{CE(sat)}^*$	Collector-emitter saturation voltage $I_C = 2A$ $I_B = 0.2A$ $I_C = 6A$ $I_B = 0.6A$		0.8	0.8	V
V_{BE}^*	Base-emitter voltage $I_C = 2A$ $V_{CE} = 2V$			1.5	V
h_{FE}^*	DC current gain $I_C = 10mA$ $V_{CE} = 5V$ for BD533 for BD535 for BD537 $I_C = 500mA$ $V_{CE} = 2V$ $I_C = 2A$ $V_{CE} = 2V$ for BD533 for BD535 for BD537	20			—
f_T	Transition frequency $I_C = 500mA$ $V_{CE} = 1V$	3	12		MHz
$h_{FE\ groups}^{**}$	J K $I_C = 2A$ $V_{CE} = 2V$ $I_C = 3A$ $V_{CE} = 2V$ $I_C = 2A$ $V_{CE} = 2V$ $I_C = 3A$ $V_{CE} = 2V$	30		75	—
		15		100	—
		40			—
		20			—

* Pulsed: pulse duration = 300 μs , duty cycle = 1.5%

** Only on request

Safe operating areas

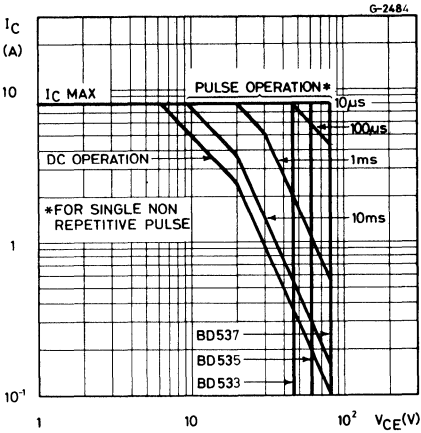

DC current gain

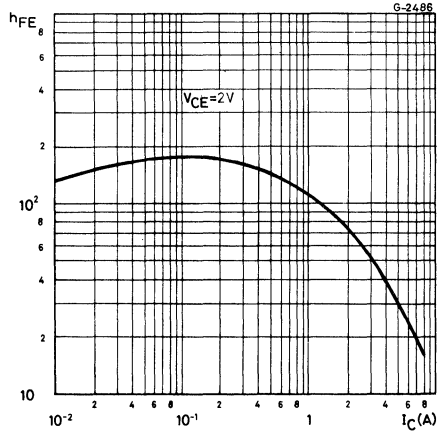

Collector-emitter saturation voltage

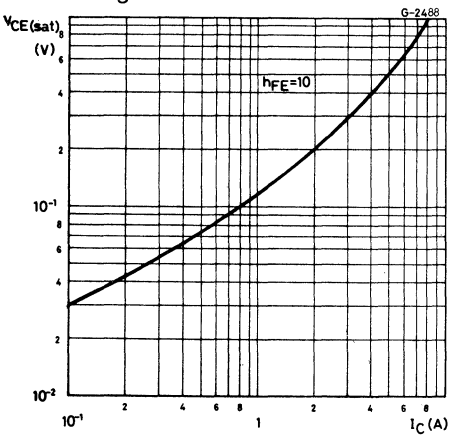

Base-emitter saturation voltage

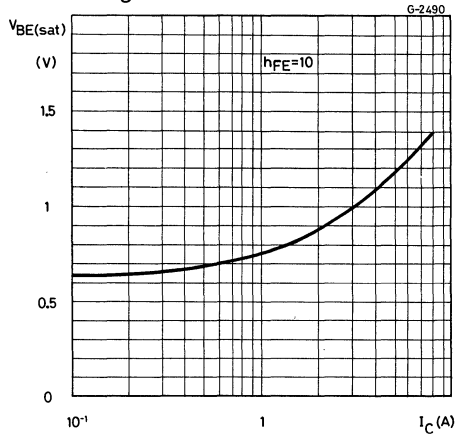

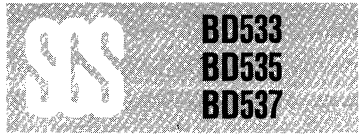

Transition frequency

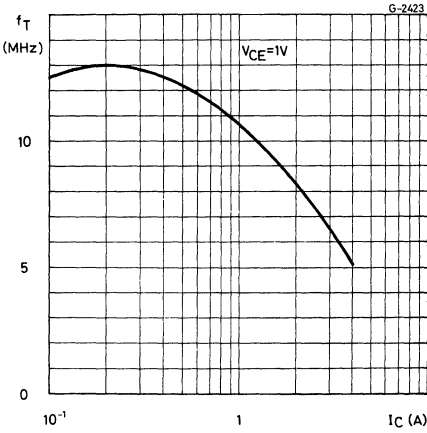

Collector-base capacitance

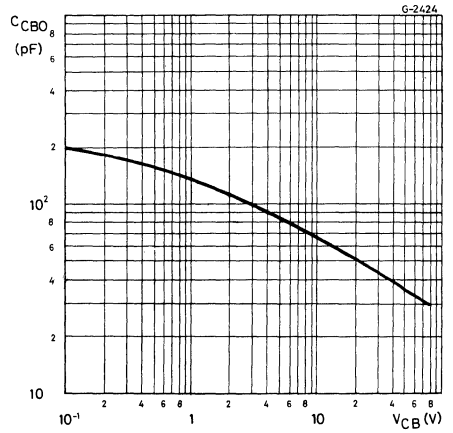

Saturated switching characteristics

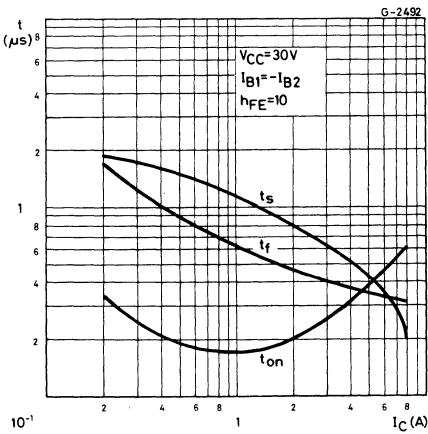

Power rating chart

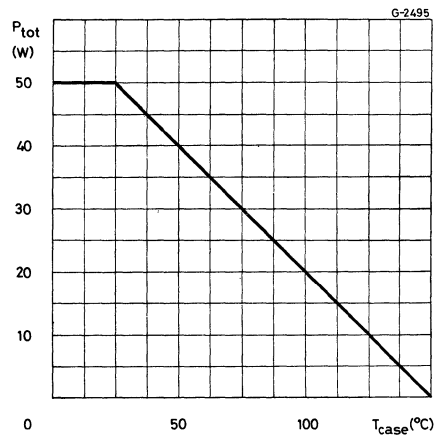

MEDIUM POWER LINEAR AND SWITCHING APPLICATIONS

The BD 534, BD 536 and BD 538 are silicon epitaxial-base PNP power transistors in Jedec TO-220 plastic package, intended for use in medium power linear and switching applications.

The complementary NPN types are the BD 533, BD 535 and BD 537 respectively.

ABSOLUTE MAXIMUM RATINGS

		BD 534	BD 536	BD 538
V_{CBO}	Collector-base voltage ($I_E = 0$)	-45V	-60V	-80V
V_{CES}	Collector-emitter voltage ($V_{BE} = 0$)	-45V	-60V	-80V
V_{CEO}	Collector-emitter voltage ($I_B = 0$)	-45V	-60V	-80V
V_{EBO}	Emitter-base voltage ($I_C = 0$)		-5V	
I_C, I_E	Collector and emitter current		-8A	
I_B	Base current		-1A	
P_{tot}	Total power dissipation at $T_{case} \leq 25^\circ C$		50 W	
T_{stg}	Storage temperature		-65 to $150^\circ C$	
T_j	Junction temperature		$150^\circ C$	

INTERNAL SCHEMATIC DIAGRAM

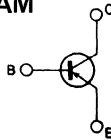

MECHANICAL DATA

Dimensions in mm

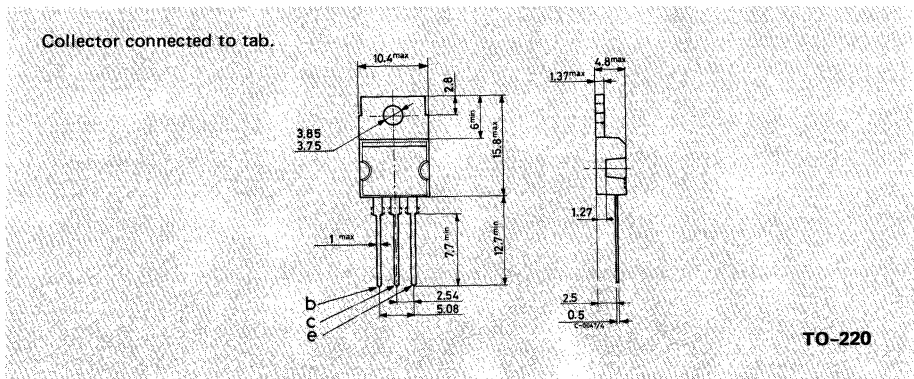



THERMAL DATA

$R_{th\ j-case}$	Thermal resistance junction-case	max	2.5	°C/W
$R_{th\ j-amb}$	Thermal resistance junction-ambient	max	70	°C/W

ELECTRICAL CHARACTERISTICS ($T_{case} = 25^{\circ}C$ unless otherwise specified)

Parameter	Test conditions	Min.	Typ.	Max.	Unit
I_{CBO}	Collector cutoff current ($I_E = 0$)	for BD534 for BD536 for BD538	$V_{CB} = -45V$ $V_{CB} = -60V$ $V_{CB} = -80V$	-100 -100 -100	μA μA μA
I_{CES}	Collector cutoff current ($V_{BE} = 0$)	for BD534 for BD536 for BD538	$V_{CE} = -45V$ $V_{CE} = -60V$ $V_{CE} = -80V$	-100 -100 -100	μA μA μA
I_{EBO}	Emitter cutoff current ($I_C = 0$)	$V_{EB} = -5V$		-1	mA
$V_{CEO(sus)}$ *	Collector-emitter sustaining voltage ($I_B = 0$)	$I_C = -100mA$	for BD 534 for BD 536 for BD 538	-45 -60 -80	V V V
$V_{CE(sat)}$ *	Collector-emitter saturation voltage	$I_C = -2A$ $I_C = -6A$	$I_B = -0.2A$ $I_B = -0.6A$	-0.8 -0.8	V V
V_{BE} *	Base-emitter voltage	$I_C = -2A$	$V_{CE} = -2V$	-1.5	V
h_{FE} *	DC current gain	$I_C = -10mA$ $I_C = -500mA$ $I_C = -2A$	$V_{CE} = -5V$ for BD 534 for BD 536 for BD 538 $V_{CE} = -2V$ $V_{CE} = -2V$ for BD 534 for BD 536 for BD 538	20 20 15 40 25 25 15	— — — — — — —
f_T	Transition frequency	$I_C = -500mA$	$V_{CE} = -1V$	3 16	MHz
h_{FE} groups**:	J K	$I_C = -2A$ $I_C = -3A$ $I_C = -2A$ $I_C = -3A$	$V_{CE} = -2V$ $V_{CE} = -2V$ $V_{CE} = -2V$ $V_{CE} = -2V$	30 15 40 20	75 — 100 —

* Pulsed: pulse duration = 300 μs , duty cycle = 1.5%

** Only on request

Safe operating areas

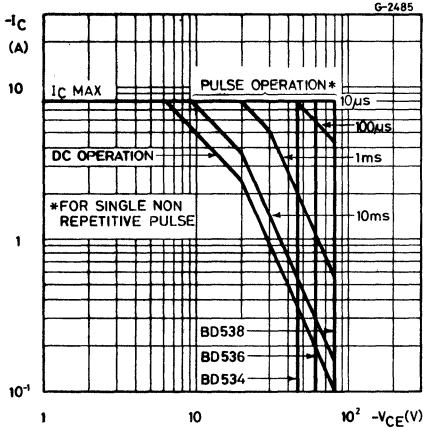

DC current gain

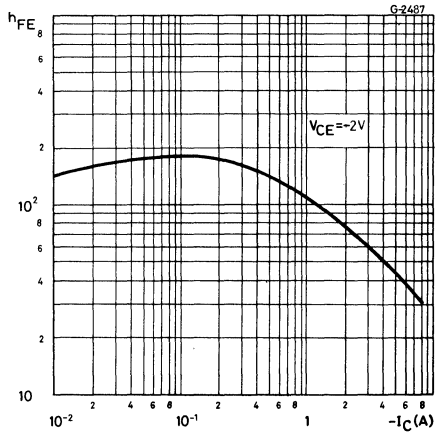

Collector-emitter saturation voltage

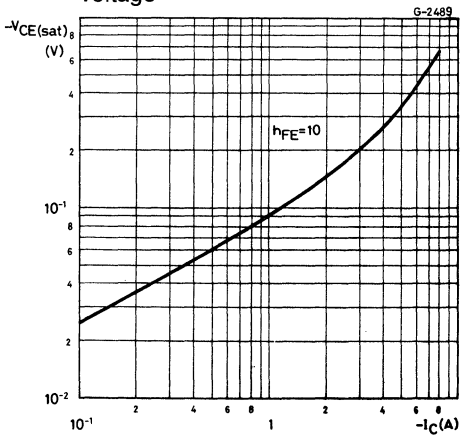

Base-emitter saturation voltage

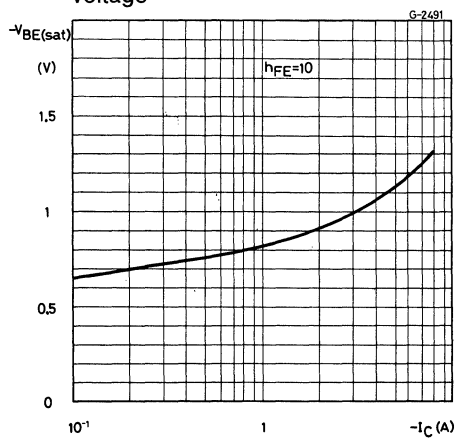



Transition frequency

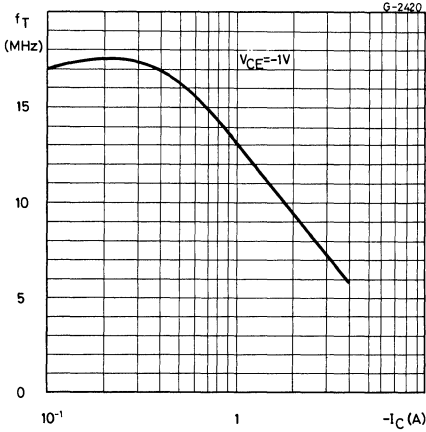

Collector-base capacitance

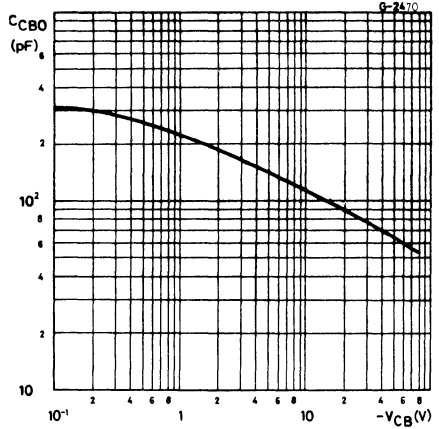

Saturated switching characteristics

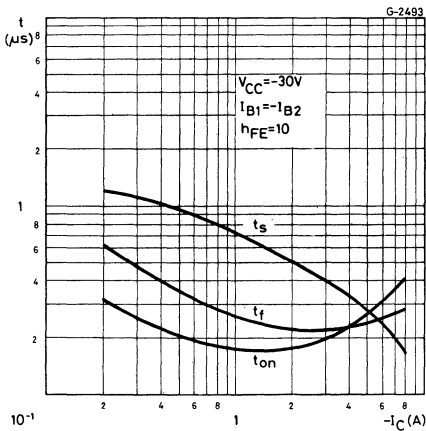

Power rating chart

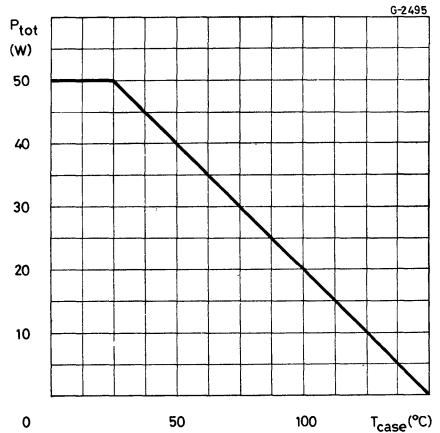



EPITAXIAL-BASE NPN

MEDIUM POWER DARLINGTONS

The BD 675A, BD 677, BD 677A, BD 679, BD 679A and BD 681 are silicon epitaxial-base NPN power transistors in monolithic Darlington configuration and are mounted in Jedec TO-126 plastic package. They are intended for use in medium power linear and switching applications. The complementary PNP types are the BD 676A, BD 678, BD 678A, BD 680, BD 680A and BD 682 respectively.

ABSOLUTE MAXIMUM RATINGS

		BD675A	BD677 BD677A	BD679 BD679A	BD681
V_{CBO}	Collector-base voltage ($I_E = 0$)	45V	60V	80V	100V
V_{CEO}	Collector-emitter voltage ($I_B = 0$)	45V	60V	80V	100V
V_{EBO}	Emitter-base voltage ($I_C = 0$)			5V	
I_C	Collector current			4A	
I_{CM}	Collector peak current (repetitive)			6A	
I_B	Base current			100mA	
P_{tot}	Total power dissipation at $T_{case} \leq 25^\circ C$			40W	
T_{stg}	Storage temperature			-65 to 150°C	
T_j	Junction temperature			150 °C	

INTERNAL SCHEMATIC DIAGRAM

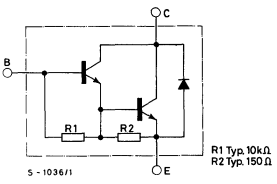

MECHANICAL DATA

Dimensions in mm

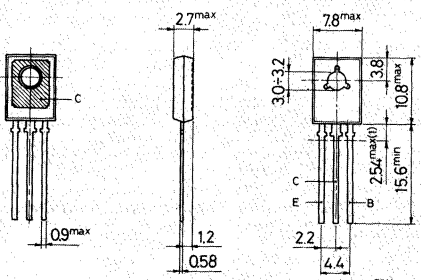

(1) Within this region the cross-section of the leads is uncontrolled

TO-126 (SOT-32)



THERMAL DATA

$R_{th\ j-case}$	Thermal resistance junction-case	max	3.12	°C/W
$R_{th\ j-amb}$	Thermal resistance junction-ambient	max	100	°C/W

ELECTRICAL CHARACTERISTICS ($T_{case} = 25^{\circ}C$ unless otherwise specified)

Parameter	Test conditions	Min. Typ. Max.	Unit
I_{CBO}	Collector cutoff current ($I_E = 0$)	for BD675A $V_{CB} = 45V$ for BD677/677A $V_{CB} = 60V$ for BD679/679A $V_{CB} = 80V$ for BD681 $V_{CB} = 100V$	200 100 200 200 μA μA μA μA
I_{CEO}	Collector cutoff current ($I_B = 0$)	for BD675A $V_{CE} = 22V$ for BD677/677A $V_{CE} = 30V$ for BD679/679A $V_{CE} = 40V$ for BD681 $V_{CE} = 50V$	500 100 500 500 μA μA μA μA
I_{EBO}	Emitter cutoff current ($I_C = 0$)	$V_{EB} = 5 V$	2 mA
$V_{CEO(sus)}^*$	Collector-emitter sustaining voltage ($I_B = 0$)	$I_C = 50 mA$ for BD675A for BD677/677A for BD679/679A for BD681	45 60 80 100 V V V V
$V_{CE(sat)}^*$	Collector-emitter saturation voltage	for BD677/679/681 $I_C = 4 A$ $I_B = 40 mA$ for BD675A/677A/679A $I_C = 2A$ $I_B = 8mA$	2.7 2.8 V V
V_{BE}^*	Base-emitter voltage	for BD677/679/681 $I_C = 1.5A$ $V_{CE} = 3V$ for BD675A/677A/679A $I_C = 2A$ $V_{CE} = 3V$	2.5 2.5 V V
h_{FE}^*	DC current gain	for BD677/679/681 $I_C = 4 A$ $V_{CE} = 3V$ for BD675A/677A/679A $I_C = 2A$ $V_{CE} = 3V$	110 750 — —
h_{fe}	Small signal current gain	$I_C = 1.5A$ $V_{CE} = 3V$ $f = 1 MHz$	1 —

* Pulsed: pulse duration = 300 μs , duty cycle = 1.5%

Safe operating areas

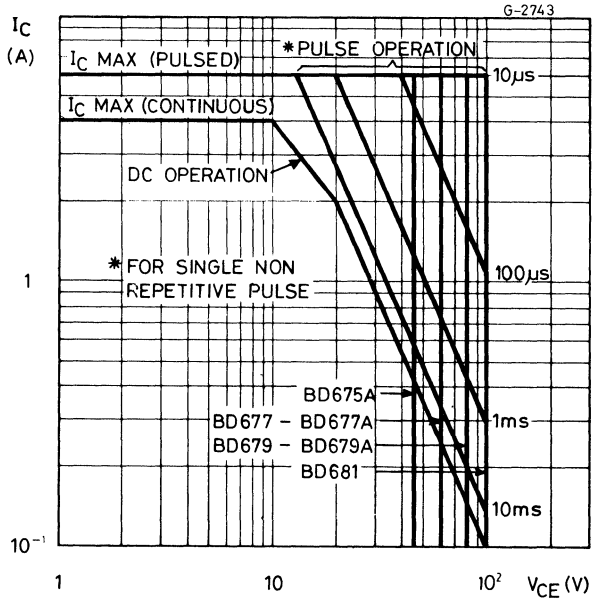

DC current gain

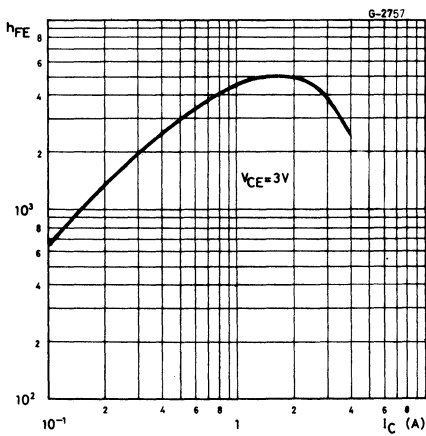

DC transconductance

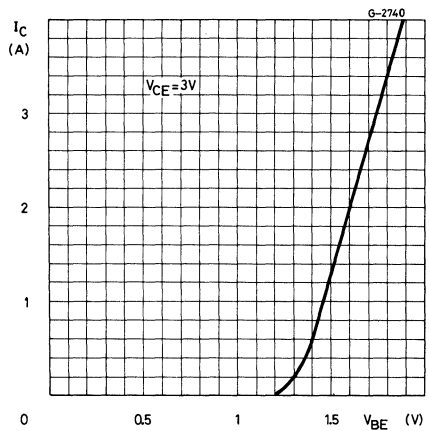



Collector-emitter saturation voltage

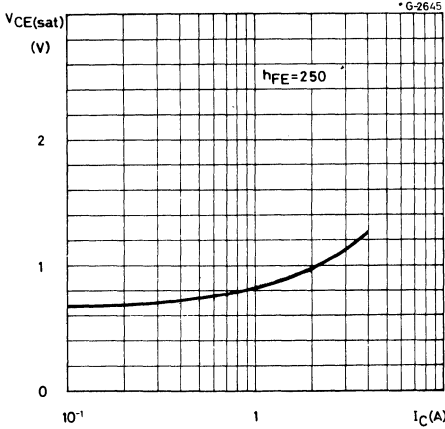

Collector-emitter saturation voltage

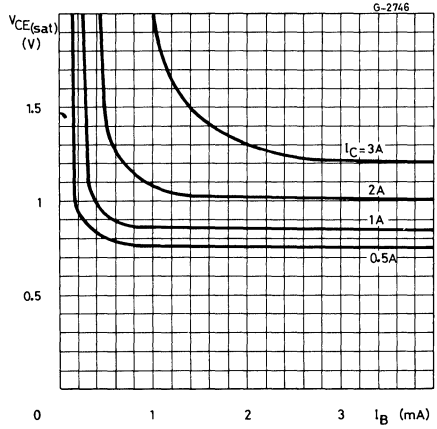

Small signal current gain

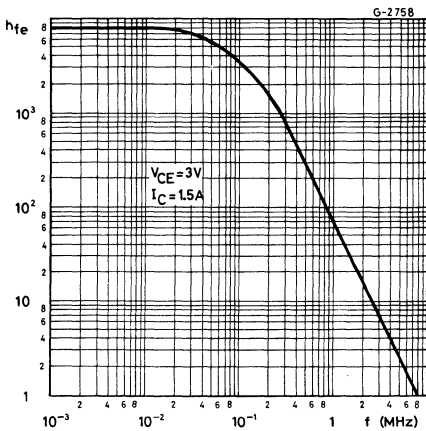

Saturated switching characteristics

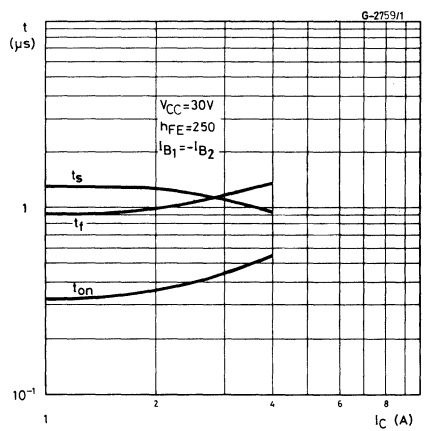



BD676A
BD678/A
BD680/A
BD682

EPITAXIAL-BASE PNP

MEDIUM POWER DARLINGTONS

The BD 676A, BD 678, BD 678A, BD 680, BD 680A and BD 682 are silicon epitaxial-base PNP power transistors in monolithic Darlington configuration and are mounted in Jedec TO-126 plastic package. They are intended for use in medium power linear and switching applications. The complementary NPN types are the BD 675A, BD 677, BD 677A, BD 679, BD 679A and BD 681 respectively.

ABSOLUTE MAXIMUM RATINGS

		BD676A	BD678 BD678A	BD680 BD680A	BD682
V_{CBO}	Collector-base voltage ($I_E = 0$)	-45V	-60V	-80V	-100V
V_{CEO}	Collector-emitter voltage ($I_B = 0$)	-45V	-60V	-80V	-100V
V_{EBO}	Emitter-base voltage ($I_C = 0$)			-5V	
I_C	Collector current			-4A	
I_{CM}	Collector peak current (repetitive)			-6A	
I_B	Base current			-100mA	
P_{tot}	Total power dissipation at $T_{case} \leq 25^\circ C$			40W	
T_{stg}	Storage temperature			-65 to 150°C	
T_j	Junction temperature			150 °C	

INTERNAL SCHEMATIC DIAGRAM

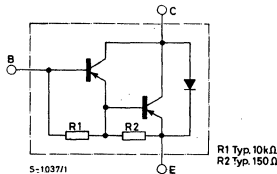

MECHANICAL DATA

Dimensions in mm

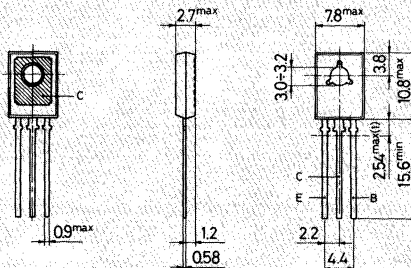

(1) Within this region the cross-section of the leads is uncontrolled

TO-126 (SOT-32)



THERMAL DATA

$R_{th\ j-case}$	Thermal resistance junction-case	max	3.12	°C/W
$R_{th\ j-amb}$	Thermal resistance junction-ambient	max	100	°C/W

ELECTRICAL CHARACTERISTICS ($T_{case} = 25^{\circ}C$ unless otherwise specified)

Parameter	Test conditions	Min.	Typ.	Max.	Unit
I_{CBO}	Collector cutoff current ($I_E = 0$)	for BD676A for BD678/678A for BD680/680A for BD682	$V_{CB} = -45V$ $V_{CB} = -60V$ $V_{CB} = -80V$ $V_{CB} = -100V$	-200 -100 -200 -200	μA μA μA μA
I_{CEO}	Collector cutoff current ($I_B = 0$)	for BD676A for BD678/678A for BD680/680A for BD682	$V_{CE} = -22V$ $V_{CE} = -30V$ $V_{CE} = -40V$ $V_{CE} = -50V$	-500 -100 -500 -500	μA μA μA μA
I_{EBO}	Emitter cutoff current ($I_C = 0$)	$V_{EB} = -5 V$		-2	mA
$V_{CEO(sus)}^*$	Collector-emitter sustaining voltage ($I_B = 0$)	$I_C = -50 mA$ for BD676A for BD678/678A for BD680/680A for BD682		-45 -60 -80 -100	V V V V
$V_{CE(sat)}^*$	Collector-emitter saturation voltage	for BD678/680/682 $I_C = -4A$ $I_B = -40mA$ for BD676A/678A/680A $I_C = -2A$ $I_B = -8mA$		-2.7 -2.8	V V
V_{BE}^*	Base-emitter voltage	for BD678/680/682 $I_C = -1.5A$ $V_{CE} = -3V$ for BD676A/678A/680A $I_C = -2A$ $V_{CE} = -3V$		-2.5 -2.5	V V
h_{FE}^*	DC current gain	for BD678/680/682 $I_C = -4A$ $V_{CE} = -3V$ for BD676A/678A/680A $I_C = -2A$ $V_{CE} = -3V$		110 750	— —
h_{fe}	Small signal current gain	$I_C = -1.5A$ $V_{CE} = -3V$ $f = 1 MHz$		1	—

* Pulsed: pulse duration = 300 μs , duty cycle = 1.5%

Safe operating areas

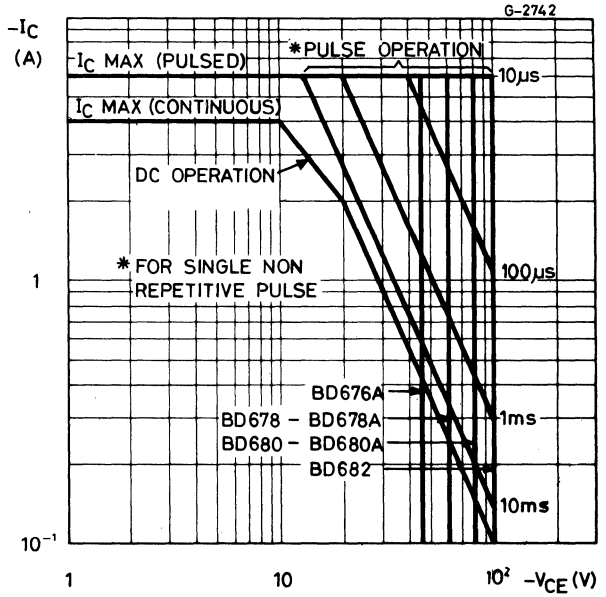

DC current gain

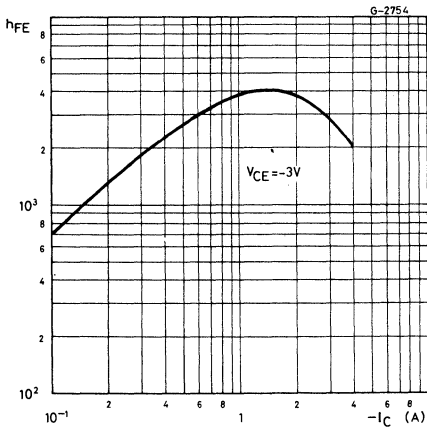

DC transconductance

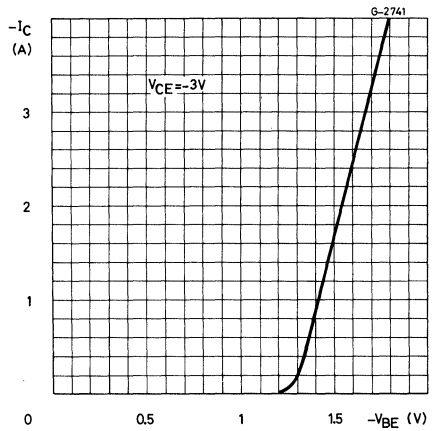



Collector-emitter saturation voltage

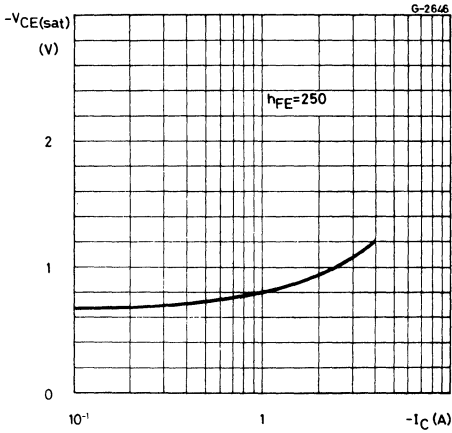

Collector-emitter saturation voltage

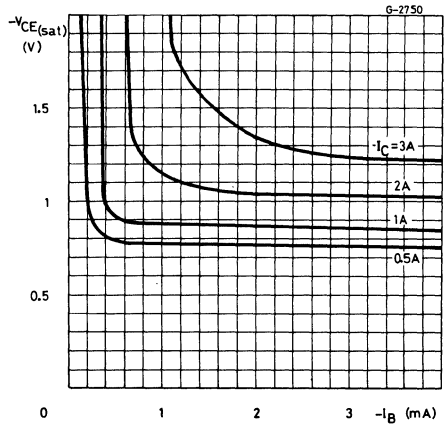

Small signal current gain

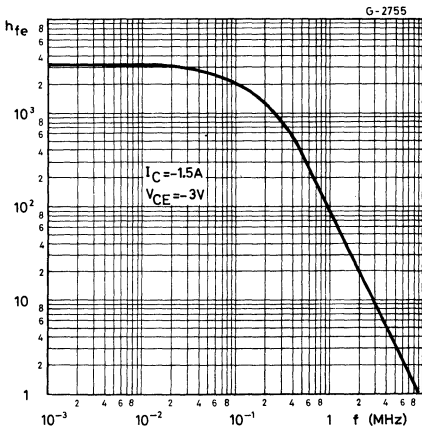

Saturated switching characteristics

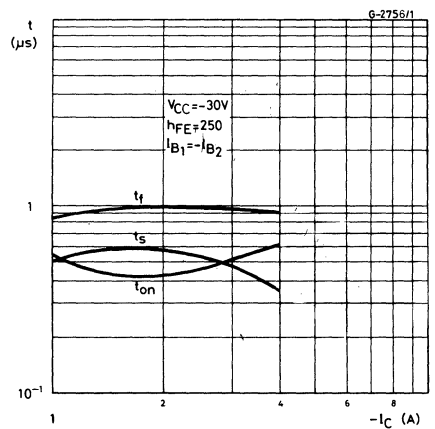

POWER LINEAR AND SWITCHING APPLICATIONS

The BD705, BD707, BD709 and BD711 are silicon epitaxial-base NPN power transistors in Jedec TO-220 plastic package intended for use in power linear and switching applications.

The complementary PNP types are the BD706, BD708, BD710 and BD712 respectively.

ABSOLUTE MAXIMUM RATINGS

		BD705	BD707	BD709	BD711
V_{CBO}	Collector-base voltage ($I_E = 0$)	45V	60V	80V	100V
V_{CES}	Collector-emitter voltage ($V_{BE} = 0$)	45V	60V	80V	100V
V_{CEO}	Collector-emitter voltage ($I_B = 0$)	45V	60V	80V	100V
V_{EBO}	Emitter-base voltage ($I_C = 0$)		5V		
I_C	Collector current		12A		
I_B	Base current		5A		
P_{tot}	Total power dissipation at $T_{case} \leq 25^\circ C$		75W		
T_{stg}	Storage temperature		-65 to 150°C		
T_j	Junction temperature		150°C		

INTERNAL SCHEMATIC DIAGRAM

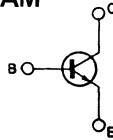

MECHANICAL DATA

Dimensions in mm

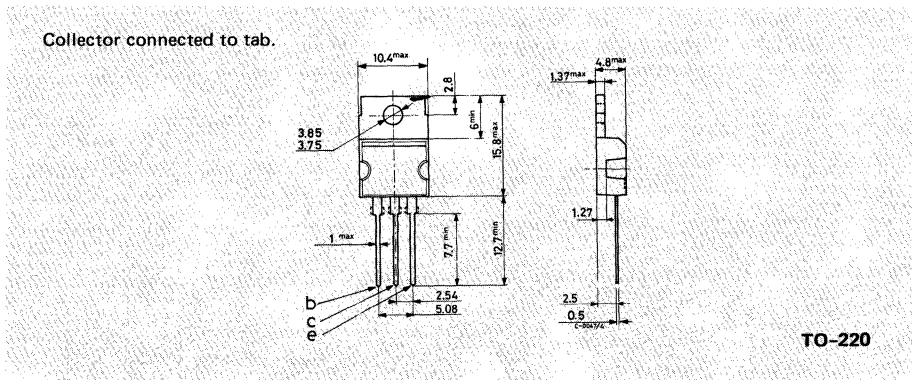



THERMAL DATA

$R_{th\ j-case}$	Thermal resistance junction-case	max	1.67	°C/W
$R_{th\ j-amb}$	Thermal resistance junction-ambient	max	70	°C/W

ELECTRICAL CHARACTERISTICS ($T_{case} = 25^{\circ}C$ unless otherwise specified)

Parameter	Test conditions	Min.	Typ.	Max.	Unit	
I_{CBO} Collector cutoff current ($I_E = 0$)	for BD705	$V_{CB} = 45\ V$		100	μA	
	for BD707	$V_{CB} = 60\ V$		100	μA	
	for BD709	$V_{CB} = 80\ V$		100	μA	
	for BD711	$V_{CB} = 100\ V$		100	μA	
	$T_{case} = 150^{\circ}C$					
	for BD705	$V_{CB} = 45\ V$			1	mA
I_{CEO} Collector cutoff current ($I_B = 0$)	for BD705	$V_{CE} = 22\ V$		1	mA	
	for BD707	$V_{CE} = 30\ V$		1	mA	
	for BD709	$V_{CE} = 40\ V$		1	mA	
	for BD711	$V_{CE} = 50\ V$		1	mA	
I_{EBO} Emitter cutoff current ($I_C = 0$)	$V_{EB} = 5\ V$			1	mA	
$V_{CEO(sus)}^*$ Collector-emitter sustaining voltage ($I_B = 0$)	$I_C = 100\ mA$	for BD705	45		V	
		for BD707	60		V	
		for BD709	80		V	
		for BD711	100		V	
$V_{CE(sat)}^*$ Collector-emitter saturation voltage	$I_C = 4\ A$	$I_B = 0.4\ A$		1	V	
V_{CEK}^* Knee voltage	$I_C = 3\ A$	$I_B = **$	0.4		V	
V_{BE}^* Base-emitter voltage	$I_C = 4\ A$	$V_{CE} = 4\ V$		1.5	V	



ELECTRICAL CHARACTERISTICS (continued)

Parameter	Test conditions	Min.	Typ.	Max.	Unit
h_{FE}^* DC current gain	$I_C = 0.5A$ $V_{CE} = 2V$	40	120	400	—
	$I_C = 2A$ $V_{CE} = 2V$ for BD705 for BD707 for BD709	30			—
		30			—
		30			—
	$I_C = 4A$ $V_{CE} = 4V$ for BD705 for BD707 for BD709 for BD711	20	30	150	—
		15		150	—
15			150	—	
15			150	—	
$I_C = 10A$ $V_{CE} = 4V$ for BD705 for BD707 for BD709 for BD711	5	10		—	
	5	10		—	
			8	—	
			8	—	
f_T Transition frequency	$I_C = 300mA$ $V_{CE} = 3V$	3			MHz

* Pulsed: pulse duration = 300 μs , duty cycle = 1.5%

** Value for which $I_C = 3.3 A$ at $V_{CE} = 2 V$

Safe operating areas

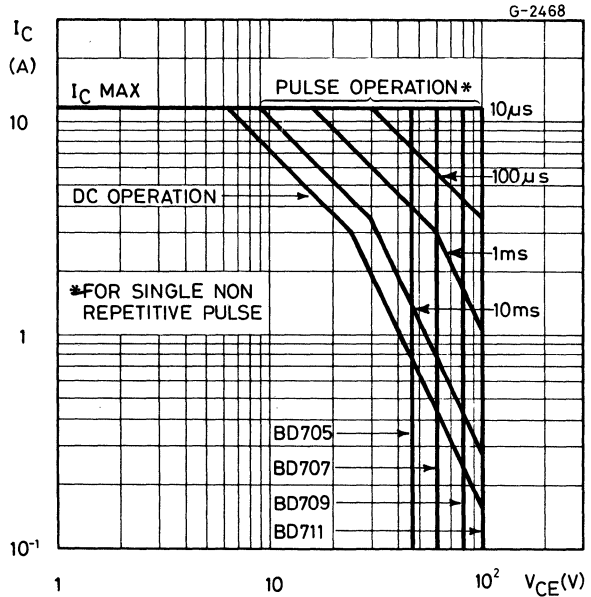



DC current gain

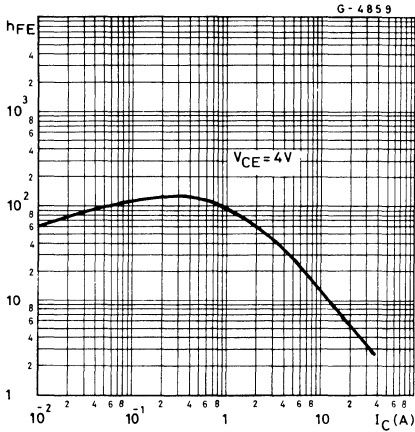

DC transconductance

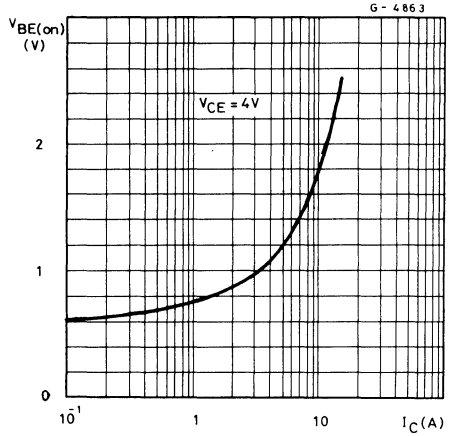

Collector-emitter saturation voltage

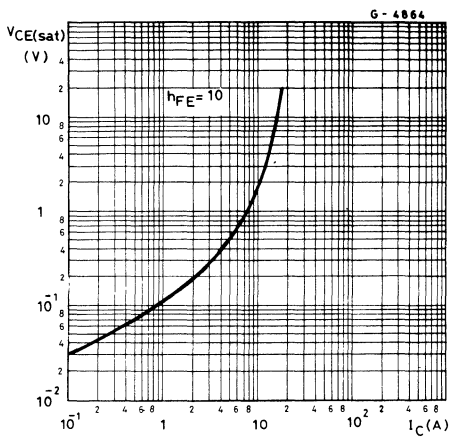

Transition frequency

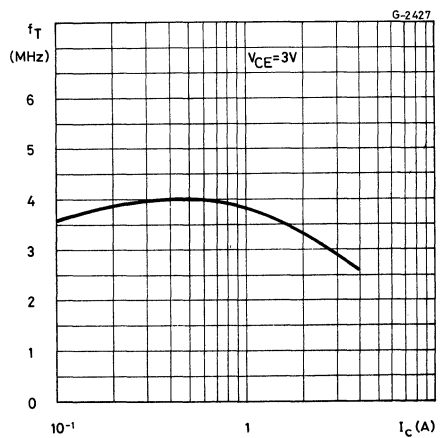



BD705
BD707
BD709
BD711

Collector-base capacitance

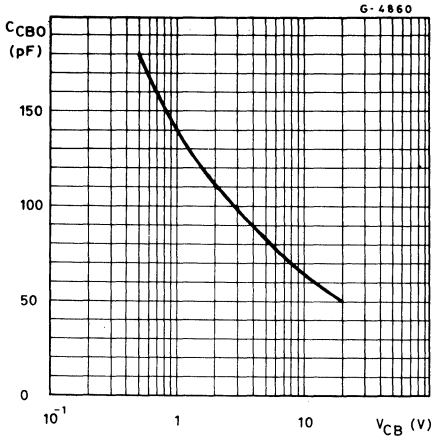

Saturated switching characteristics

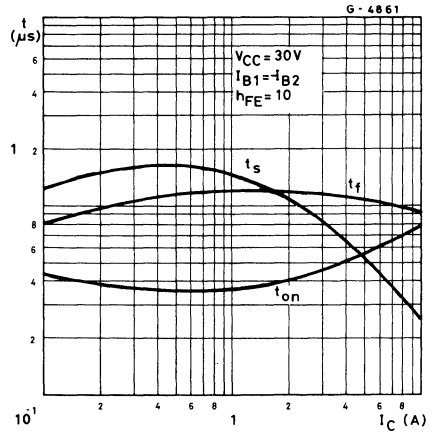

Power rating chart

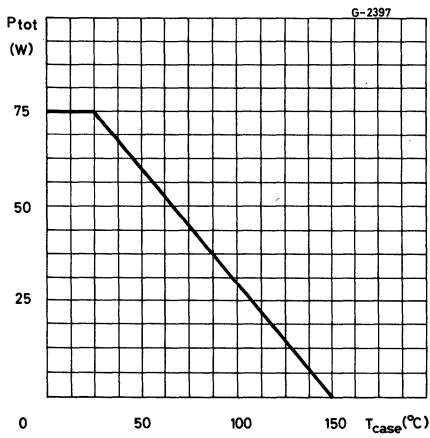

EPITAXIAL-BASE PNP



POWER LINEAR AND SWITCHING APPLICATIONS

The BD706, BD708, BD710 and BD712 are silicon epitaxial-base PNP power transistors in Jedec TO-220 plastic package, intended for use in power linear and switching applications.

The complementary NPN types are the BD705, BD707, BD709 and BD711 respectively.

ABSOLUTE MAXIMUM RATINGS

		BD706	BD708	BD710	BD712
V_{CBO}	Collector-base voltage ($I_E = 0$)	-45V	-60V	-80V	-100V
V_{CES}	Collector-emitter voltage ($V_{BE} = 0$)	-45V	-60V	-80V	-100V
V_{CEO}	Collector-emitter voltage ($I_B = 0$)	-45V	-60V	-80V	-100V
V_{EBO}	Emitter-base voltage ($I_C = 0$)			-5V	
I_C	Collector current			-12A	
I_B	Base current			-5A	
P_{tot}	Total power dissipation at $T_{case} \leq 25^\circ C$			75W	
T_{stg}	Storage temperature			-65 to 150°C	
T_j	Junction temperature			150°C	

INTERNAL SCHEMATIC DIAGRAM

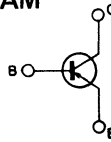

MECHANICAL DATA

Dimensions in mm

Collector connected to tab.

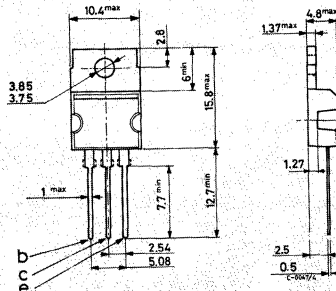

TO-220



THERMAL DATA

$R_{th\ j-case}$	Thermal resistance junction-case	max	1.67	°C/W
$R_{th\ j-amb}$	Thermal resistance junction-ambient	max	70	°C/W

ELECTRICAL CHARACTERISTICS ($T_{case} = 25^{\circ}C$ unless otherwise specified)

Parameter	Test conditions	Min.	Typ.	Max.	Unit	
I_{CBO} Collector cutoff current ($I_E = 0$)	for BD706	$V_{CB} = -45\ V$		-100	μA	
	for BD708	$V_{CB} = -60\ V$		-100	μA	
	for BD710	$V_{CB} = -80\ V$		-100	μA	
	for BD712	$V_{CB} = -100\ V$		-100	μA	
	$T_{case} = 150^{\circ}C$					
	for BD706	$V_{CB} = -45\ V$			-1	mA
for BD708	$V_{CB} = -60\ V$			-1	mA	
for BD710	$V_{CB} = -80\ V$			-1	mA	
for BD712	$V_{CB} = -100\ V$			-1	mA	
I_{CEO} Collector cutoff current ($I_B = 0$)	for BD706	$V_{CE} = -22\ V$		-1	mA	
	for BD708	$V_{CE} = -30\ V$		-1	mA	
	for BD710	$V_{CE} = -40\ V$		-1	mA	
	for BD712	$V_{CE} = -50\ V$		-1	mA	
I_{EBO} Emitter cutoff current ($I_C = 0$)	$V_{EB} = -5\ V$			-1	mA	
$V_{CEO(sus)}^*$ Collector-emitter sustaining voltage ($I_B = 0$)	$I_C = -100\ mA$	for BD706	-45		V	
		for BD708	-60		V	
		for BD710	-80		V	
		for BD712	-100		V	
$V_{CE(sat)}^*$ Collector-emitter saturation voltage	$I_C = -4\ A$	$I_B = -0.4\ A$		-1	V	
V_{CEK}^* Knee voltage	$I_C = -3\ A$	$I_B = **$		-0.4	V	
V_{BE}^* Base-emitter voltage	$I_C = -4\ A$	$V_{CE} = -4\ V$		-1.5	V	



ELECTRICAL CHARACTERISTICS (continued)

Parameter	Test conditions	Min.	Typ.	Max.	Unit
h_{FE}^* DC current gain	$I_C = -0.5A$ $V_{CE} = -2V$ $I_C = -2A$ $V_{CE} = -2V$ for BD706 for BD708 for BD710	40	120	400	—
		30			—
		30			—
	$I_C = -4A$ $V_{CE} = -4V$ for BD706 for BD708 for BD710 for BD712	20	30	150	—
		15		150	—
15			150	—	
$I_C = -10A$ $V_{CE} = -4V$ for BD706 for BD708 for BD710 for BD712	15		150	—	
	5	12		—	
	5	12		—	
				8	—
				8	—
f_T Transition frequency	$I_C = -300mA$ $V_{CE} = -3V$	3			MHZ

* Pulsed: pulse duration = 300 μs , duty cycle = 1.5%

** Value for which $I_C = -3.3 A$ at $V_{CE} = -2 V$

Safe operating areas

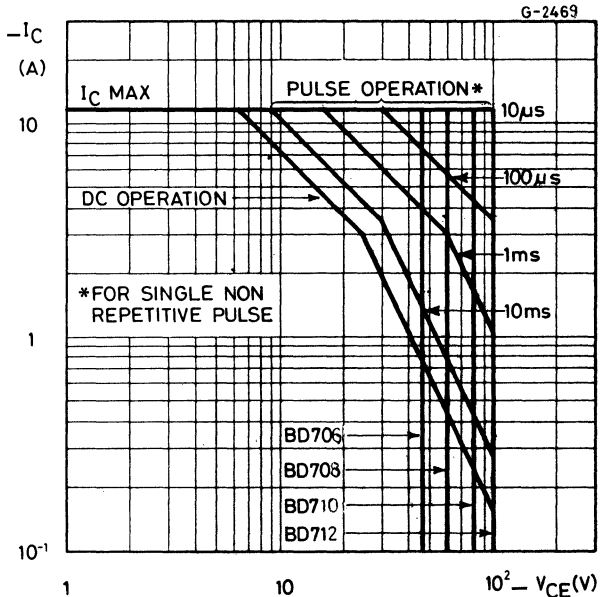

DC current gain

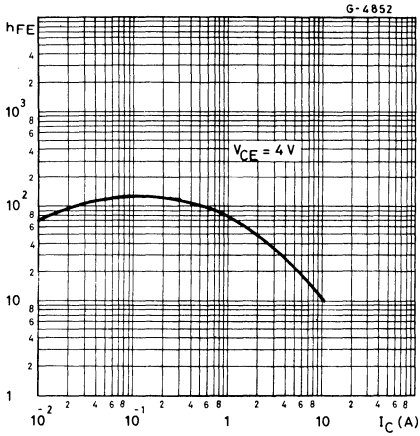

DC transconductance

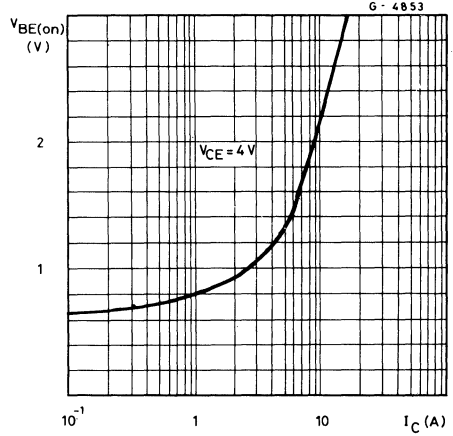

Collector-emitter saturation voltage

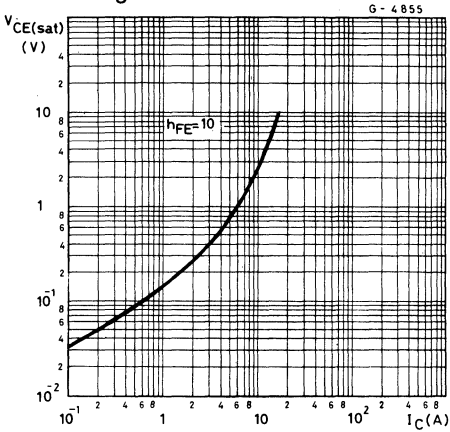

Transition frequency

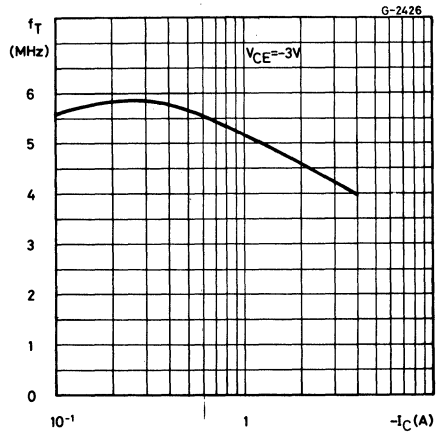

Collector-base capacitance

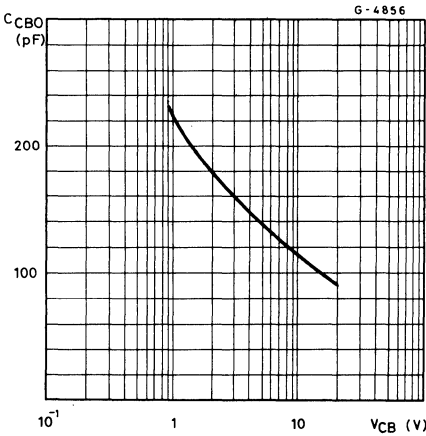

Saturated switching characteristics

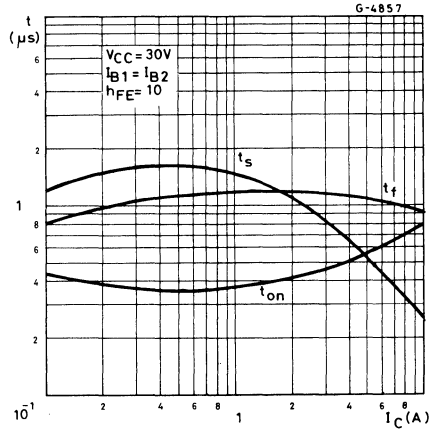

Power rating chart

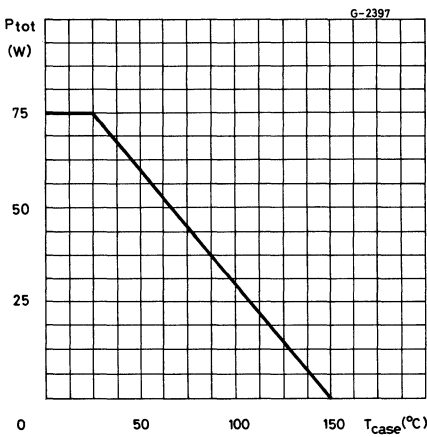

POWER LINEAR AND SWITCHING APPLICATIONS

The BD 905, BD 907, BD 909, BD 911 are silicon epitaxial-base NPN power transistors in Jedec TO-220 plastic package. They are intended for use in power linear and switching applications.

The complementary PNP types are the BD 906, BD 908, BD 910 and BD 912 respectively.

ABSOLUTE MAXIMUM RATINGS

		BD905	BD907	BD909	BD911
V_{CBO}	Collector-base voltage ($I_E = 0$)	45V	60V	80V	100V
V_{CEO}	Collector-emitter voltage ($I_B = 0$)	45V	60V	80V	100V
V_{EBO}	Emitter-base voltage ($I_C = 0$)			5V	
I_E, I_C	Emitter and collector current			15A	
I_B	Base current			5A	
P_{tot}	Total power dissipation at $T_{case} \leq 25^\circ C$			90W	
T_{stg}	Storage temperature			-65 to 150°C	
T_j	Junction temperature			150°C	

INTERNAL SCHEMATIC DIAGRAM

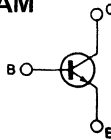

MECHANICAL DATA

Dimensions in mm

Collector connected to tab.

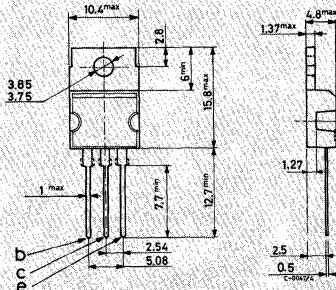

TO-220



THERMAL DATA

$R_{th\ j-case}$	Thermal resistance junction-case	max	1.4	°C/W
------------------	----------------------------------	-----	-----	------

ELECTRICAL CHARACTERISTICS ($T_{case} = 25^{\circ}C$ unless otherwise specified)

Parameter	Test conditions	Min.	Typ.	Max.	Unit
I_{CBO} Collector cutoff current ($I_E = 0$)	for BD905	$V_{CB} = 45V$		500	μA
	for BD907	$V_{CB} = 60V$		500	μA
	for BD909	$V_{CB} = 80V$		500	μA
	for BD911	$V_{CB} = 100V$		500	μA
	$T_{case} = 150^{\circ}C$				
	for BD905	$V_{CB} = 45V$		5	mA
for BD907	$V_{CB} = 60V$		5	mA	
for BD909	$V_{CB} = 80V$		5	mA	
for BD911	$V_{CB} = 100V$		5	mA	
I_{CEO} Collector cutoff current ($I_B = 0$)	for BD905	$V_{CE} = 30V$		1	mA
	for BD907	$V_{CE} = 30V$		1	mA
	for BD909	$V_{CE} = 40V$		1	mA
	for BD911	$V_{CE} = 50V$		1	mA
I_{EBO} Emitter cutoff current ($I_C = 0$)	$V_{EB} = 5V$			1	mA
$V_{CEO(sus)}$ * Collector-emitter sustaining voltage ($I_B = 0$)	$I_C = 100mA$	for BD905	45		V
		for BD907	60		V
		for BD909	80		V
		for BD911	100		V
$V_{CE(sat)}$ * Collector-emitter saturation voltage	$I_C = 5A$	$I_B = 0.5A$		1	V
	$I_C = 10A$	$I_B = 2.5A$		3	V
$V_{BE(sat)}$ * Base-emitter saturation voltage	$I_C = 10A$	$I_B = 2.5A$		2.5	V
V_{BE} * Base-emitter voltage	$I_C = 5A$	$V_{CE} = 4V$		1.5	V
h_{FE} * DC current gain	$I_C = 0.5A$	$V_{CE} = 4V$	40	250	—
	$I_C = 5A$	$V_{CE} = 4V$	15	150	—
	$I_C = 10A$	$V_{CE} = 4V$	5	—	—
f_T Transition frequency	$I_C = 0.5A$	$V_{CE} = 4V$	3		MHz

* Pulsed: pulse duration = 300 μs , duty cycle = 1.5%



BD905
BD907
BD909
BD911

Safe operating areas

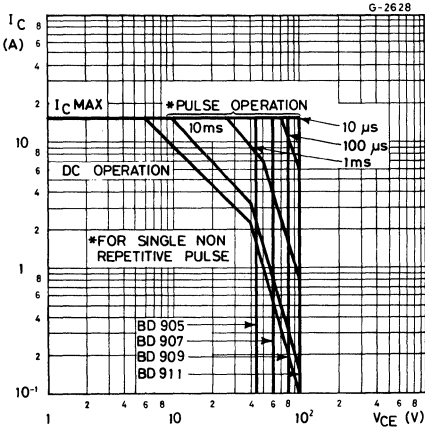

DC current gain

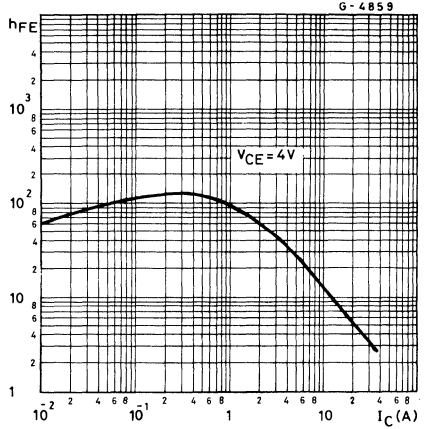

DC transconductance

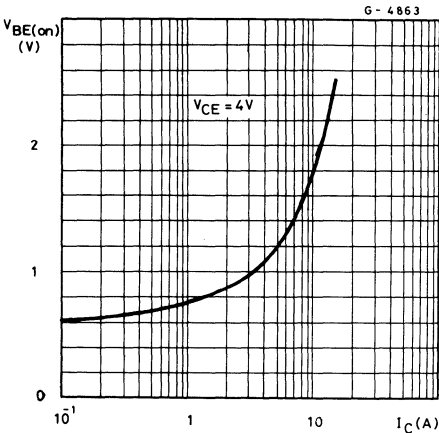

Collector-emitter saturation voltage

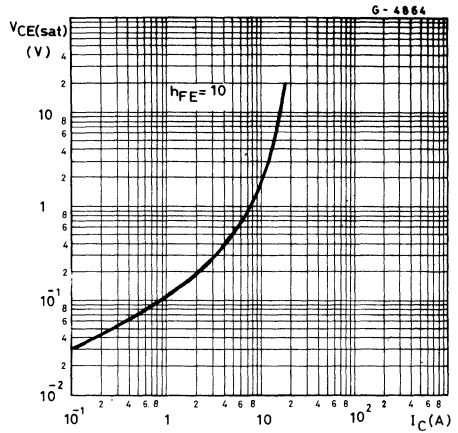



Base-emitter saturation voltage

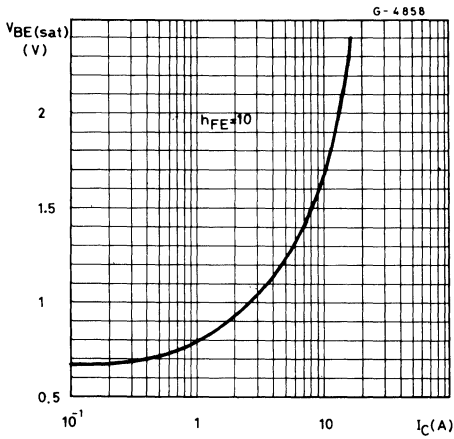

Transition frequency

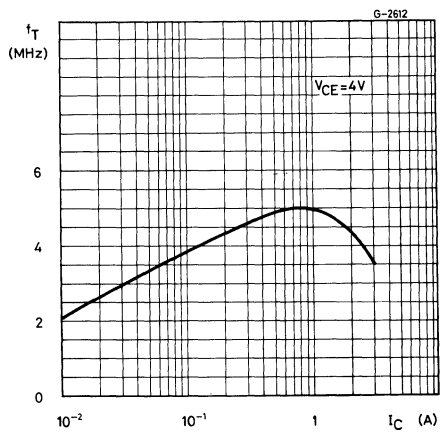

Collector-base capacitance

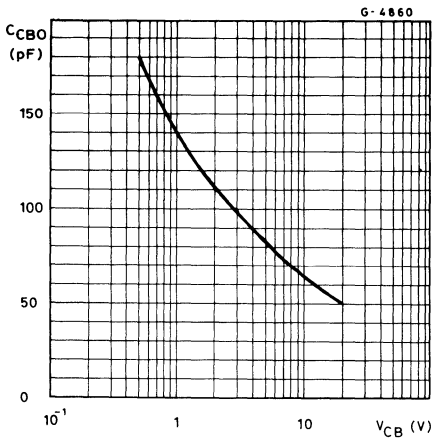

Power rating chart

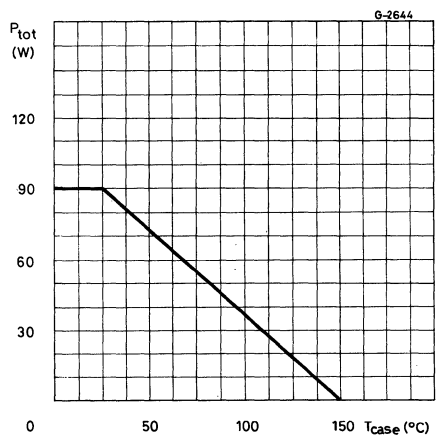



EPITAXIAL-BASE PNP

POWER LINEAR AND SWITCHING APPLICATIONS

The BD 906, BD 908, BD 910 and BD 912 are silicon epitaxial-base PNP power transistors in Jedec TO-220 plastic package.

They are intended for use in power linear and switching applications.

The complementary NPN types are the BD 905, BD 907, BD 909 and BD 911 respectively.

ABSOLUTE MAXIMUM RATINGS

		BD906	BD908	BD910	BD912
V_{CBO}	Collector-base voltage ($I_E = 0$)	-45V	-60V	-80V	-100V
V_{CEO}	Collector-emitter voltage ($I_B = 0$)	-45V	-60V	-80V	-100V
V_{EBO}	Emitter-base voltage ($I_C = 0$)			-5V	
I_E, I_C	Emitter and collector current			-15A	
I_B	Base current			-5A	
P_{tot}	Total power dissipation at $T_{case} \leq 25^\circ C$			90W	
T_{stg}	Storage temperature			-65 to $150^\circ C$	
T_j	Junction temperature			$150^\circ C$	

INTERNAL SCHEMATIC DIAGRAM

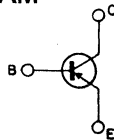

MECHANICAL DATA

Dimensions in mm

Collector connected to tab.

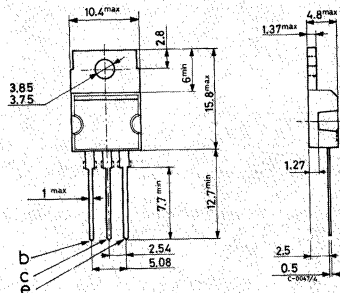

TO-220

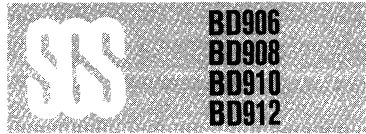

THERMAL DATA

$R_{th\ j-case}$	Thermal resistance junction-case	max	1.4 °C/W
------------------	----------------------------------	-----	----------

ELECTRICAL CHARACTERISTICS ($T_{case} = 25^{\circ}C$ unless otherwise specified)

Parameter	Test conditions	Min.	Typ.	Max.	Unit
I_{CBO} Collector cutoff current ($I_E = 0$)	for BD906 $V_{CB} = -45V$ for BD908 $V_{CB} = -60V$ for BD910 $V_{CB} = -80V$ for BD912 $V_{CB} = -100V$ $T_{case} = 150^{\circ}C$ for BD906 $V_{CB} = -45V$ for BD908 $V_{CB} = -60V$ for BD910 $V_{CB} = -80V$ for BD912 $V_{CB} = -100V$			-500 -500 -500 -500 -5 -5 -5 -5	μA μA μA μA mA mA mA mA
I_{CEO} Collector cutoff current ($I_B = 0$)	for BD906 $V_{CE} = -30V$ for BD908 $V_{CE} = -30V$ for BD910 $V_{CE} = -40V$ for BD912 $V_{CE} = -50V$			-1 -1 -1 -1	mA mA mA mA
I_{EBO} Emitter cutoff current ($I_C = 0$)	$V_{EB} = -5V$			-1	mA
$V_{CEO(sus)}$ * Collector-emitter sustaining voltage ($I_B = 0$)	$I_C = -100mA$ for BD906 for BD908 for BD910 for BD912			-45 -60 -80 -100	V V V V
$V_{CE(sat)}$ * Collector-emitter saturation voltage	$I_C = -5A$ $I_B = -0.5A$ $I_C = -10A$ $I_B = -2.5A$			-1 -3	V V
$V_{BE(sat)}$ * Base-emitter saturation voltage	$I_C = -10A$ $I_B = -2.5A$			-2.5	V
V_{BE} * Base-emitter voltage	$I_C = -5A$ $V_{CE} = -4V$			-1.5	V
h_{FE} * DC current gain	$I_C = -0.5A$ $V_{CE} = -4V$ $I_C = -5A$ $V_{CE} = -4V$ $I_C = -10A$ $V_{CE} = -4V$			40 15 5	250 150 —
f_T Transition frequency	$I_C = -0.5A$ $V_{CE} = -4V$			3	MHz

* Pulsed: pulse duration = 300 μs , duty cycle = 1.5%



Safe operating areas

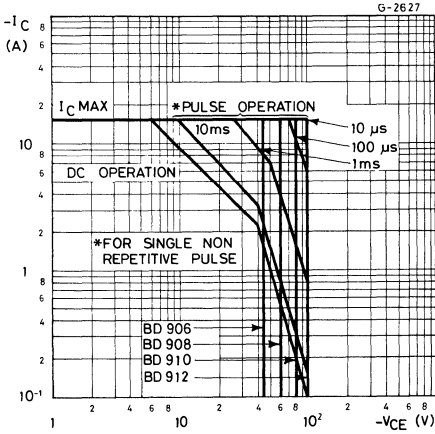

DC current gain

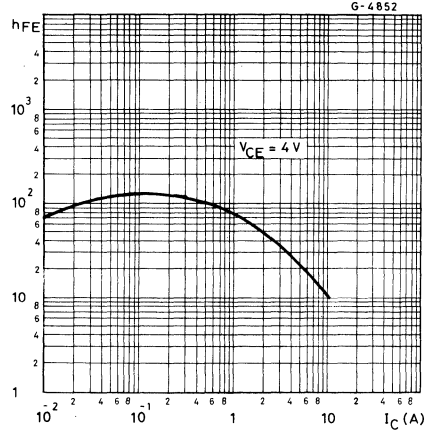

DC transconductance

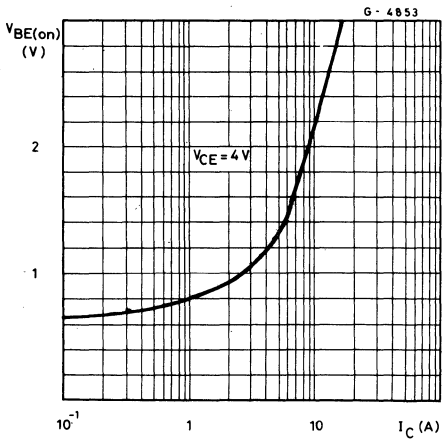

Collector-emitter saturation voltage

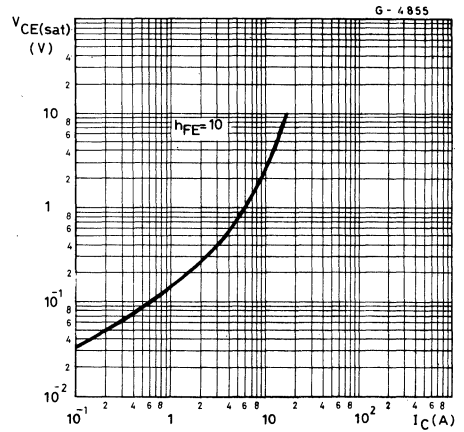



Base-emitter saturation voltage

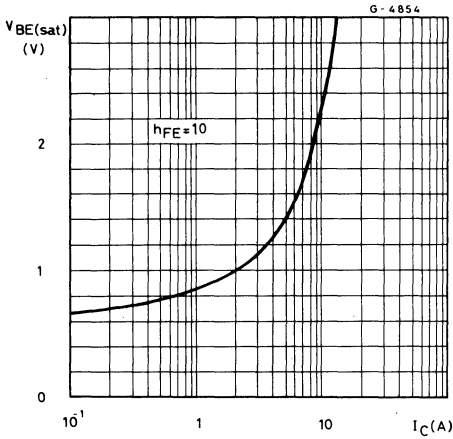

Transition frequency

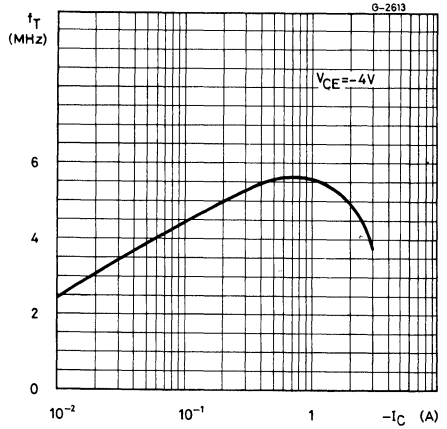

Collector-base capacitance

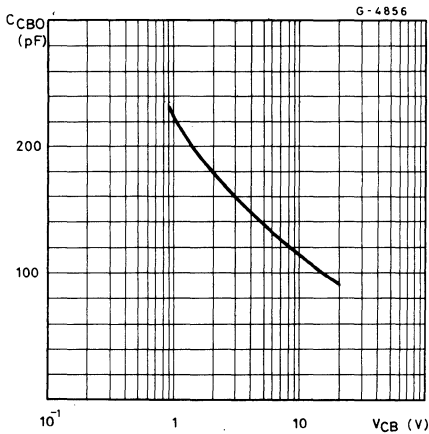

Power rating chart

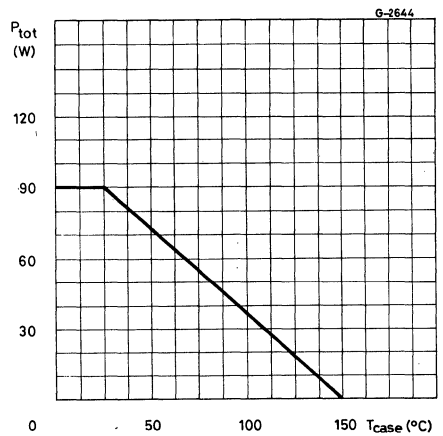

POWER DARLINGTONS

The BDV65, BDV65A, BDV65B, are silicon epitaxial-base NPN transistors in monolithic Darlington configuration and are mounted in SOT-93 plastic package. They are intended for use in power linear and switching applications.

The complementary PNP types are BDV64, BDV64A, BDV64B respectively.

ABSOLUTE MAXIMUM RATINGS

		* PNP NPN	BDV64 BDV65	BDV64A BDV65A	BDV64B BDV65B
V_{CBO}	Collector-base voltage ($I_E = 0$)		60V	80V	100V
V_{CEO}	Collector-emitter voltage ($I_B = 0$)		60V	80V	100V
V_{EBO}	Emitter-base voltage ($I_C = 0$)			5V	
I_C	Collector current			12A	
I_{CM}	Collector peak current (repetitive)			20A	
I_B	Base current			0.5A	
P_{tot}	Total power dissipation at $T_{case} \leq 25^\circ C$			125W	
T_{stg}	Storage temperature			-65 to 150°C	
T_j	Junction temperature			150°C	

* For PNP types voltage and current values are negative

INTERNAL SCHEMATIC DIAGRAMS

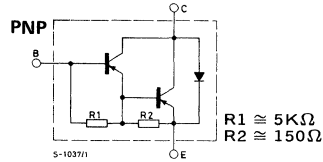
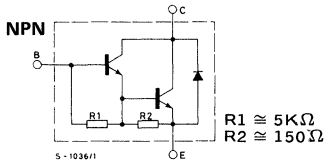

MECHANICAL DATA

Dimensions in mm

Collector connected to tab.

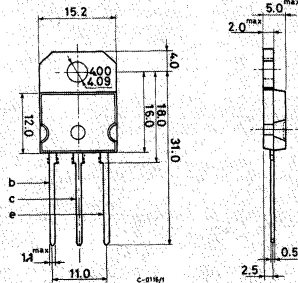

(sim. to TO-218) SOT-93



THERMAL DATA

$R_{th\ j-case}$	Thermal resistance junction-case	max. 1 °C/W
------------------	----------------------------------	-------------

ELECTRICAL CHARACTERISTICS ($T_{case} = 25^{\circ}C$ unless otherwise specified)

Parameter	Test conditions	Min.	Typ.	Max.	Unit
I_{CBO}	Collector cutoff current ($I_E = 0$)	for BDV64/5 for BDV64A/5A for BDV64B/5B $T_{case} = 150^{\circ}C$ for BDV64/65 for BDV64A/5A for BDV64B/5B	$V_{CB} = 60V$ $V_{CB} = 80V$ $V_{CB} = 100V$ $V_{CB} = 30V$ $V_{CB} = 40V$ $V_{CB} = 50V$	400 400 400 2 2 2	μA μA μA mA mA mA
I_{CEO}	Collector cutoff current ($I_B = 0$)	for BDV64/65 for BDV64A/5A for BDV64B/5B	$V_{CE} = 30V$ $V_{CE} = 40V$ $V_{CE} = 50V$	1 1 1	mA mA mA
I_{EBO}	Emitter cutoff current ($I_C = 0$)	$V_{EBO} = 5V$		5	mA
$V_{CEO(sus)}^*$	Collector-emitter sustaining voltage ($I_B = 0$)	$I_C = 30mA$	for BDV64/65 for BDV64A/5A for BDV64B/5B	60 80 100	V V V
$V_{CE(sat)}^*$	Collector-emitter saturation voltage	$I_C = 5A$	$I_B = 20mA$	2	V
V_{BE}^*	Base-emitter voltage	$I_C = 5A$	$V_{CE} = 4V$	2.5	V
h_{FE}^*	DC current gain	$I_C = 1A$ $I_C = 5A$ $I_C = 10A$	$V_{CE} = 4V$ $V_{CE} = 4V$ $V_{CE} = 4V$	2500 1000 500	— — —
V_F	Parallel diode forward voltage	$I_F = 5A$		1.2	V

ELECTRICAL CHARACTERISTICS (continued)

Parameter	Test conditions	Min.	Typ.	Max.	Unit
h_{fe}	Small signal current gain $I_C = 5A$ $f = 1\text{ MHz}$		60		—
C_{CBO}	Collector-base capacitance $V_{CB} = 10V$ $f = 1\text{ MHz}$		100		pF
t_{on}	Turn-on time $I_C = 5A$		0.5		μs
t_s	Storage time $I_{B2} = 20A$	$I_{B1} = 20mA$	1.1	**	μs
		$V_{CC} = 16V$	1.3		μs
t_f	Fall time $I_{B2} = 20A$	$V_{CC} = 16V$	2.5	**	μs
			1.0		μs

* Pulsed: pulse duration = 300 μs duty cycle = 1.5%

** For PNP types

For PNP types voltage and current values are negative

Safe operating areas

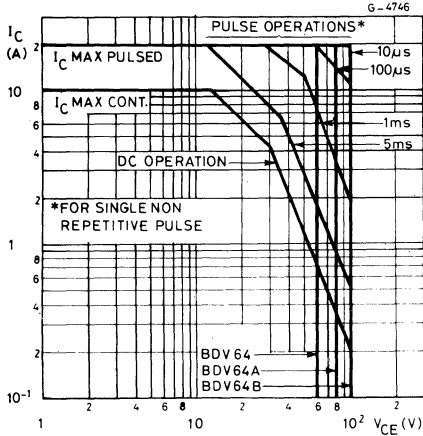

Safe operating areas

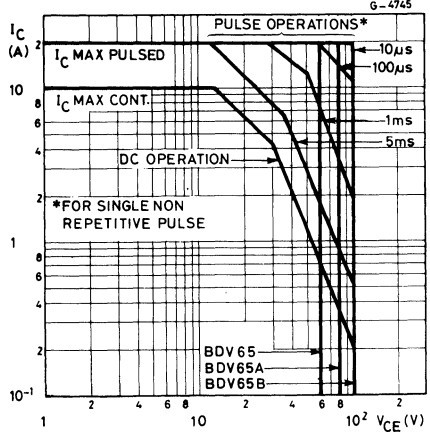



DC current gain (BDV64 series)

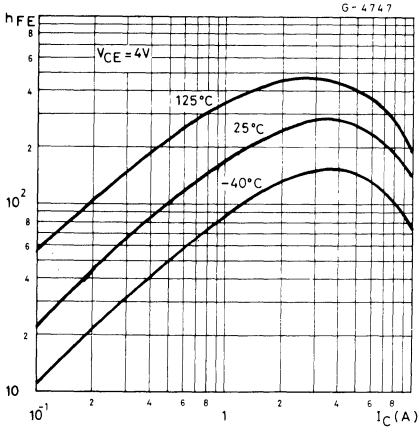

DC transconductance (BDV64 series)

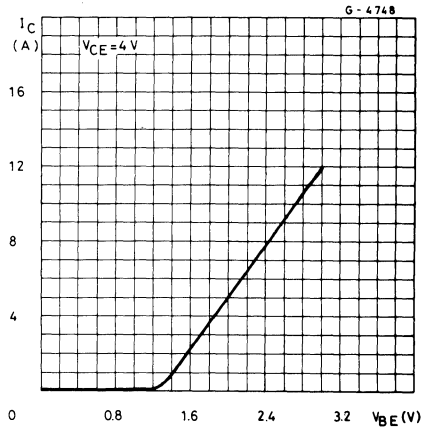

Collector-emitter saturation voltage (BDV64 series)

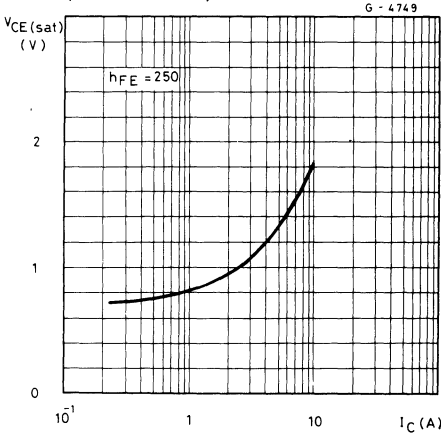

Collector-emitter saturation voltage (BDV64 series)

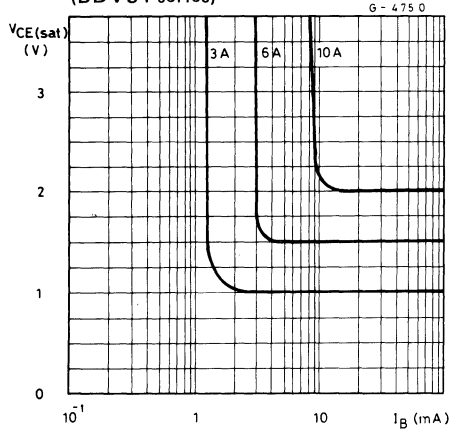

DC current gain (BDV65 series)

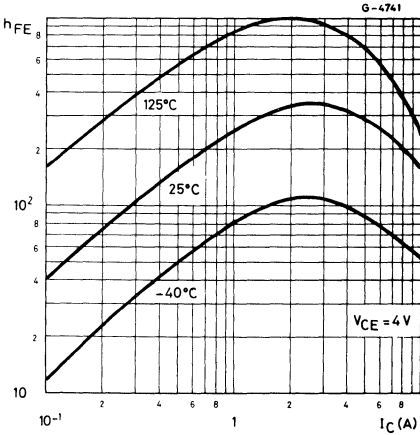

DC transconductance (BDV65 series)

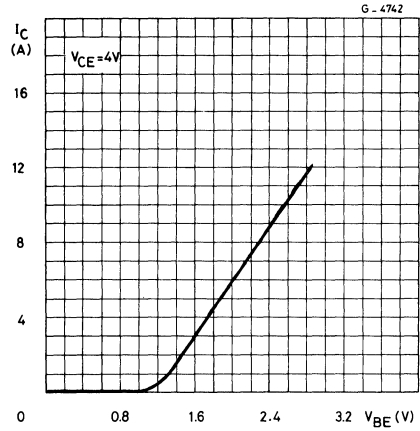

Collector-emitter saturation voltage (BDV65 series)

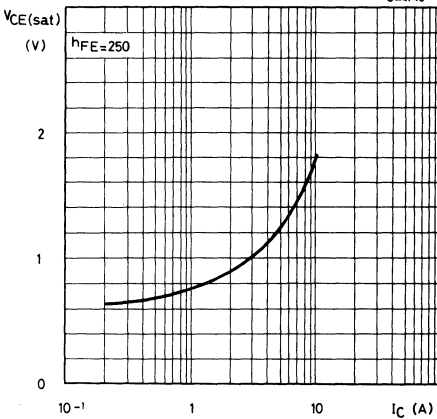

Collector-emitter saturation voltage (BDV65 series)

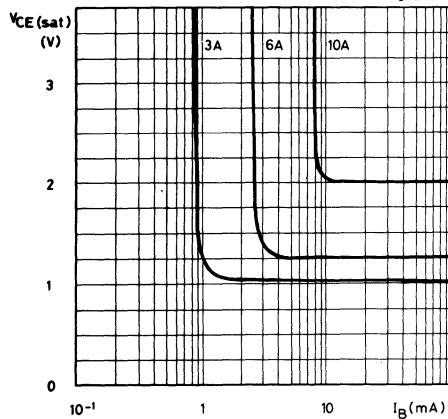

EPITAXIAL-BASE NPN

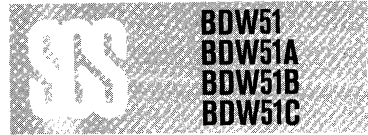

POWER LINEAR AND SWITCHING APPLICATIONS

The BDW 51, BDW 51A, BDW 51B and BDW 51C are silicon epitaxial-base NPN power transistors in Jedec TO-3 metal case. They are intended for use in power linear and switching applications.

The complementary PNP types are the BDW 52, BDW 52A, BDW 52B and BDW 52C respectively.

ABSOLUTE MAXIMUM RATINGS

		BDW51	BDW51A	BDW51B	BDW51C
V_{CBO}	Collector-base voltage ($I_E = 0$)	45V	60V	80V	100V
V_{CES}	Collector-emitter voltage ($V_{BE} = 0$)	45V	60V	80V	100V
V_{CEO}	Collector-emitter voltage ($I_B = 0$)	45V	60V	80V	100V
V_{EBO}	Emitter-base voltage ($I_C = 0$)		5V		
I_C	Collector current		15A		
I_{CM}	Collector peak current (repetitive)		20A		
I_B	Base current		7A		
P_{tot}	Total power dissipation at $T_{case} \leq 25^\circ C$		125W		
T_{stg}	Storage temperature		-65 to 200°C		
T_j	Junction temperature		200 °C		

INTERNAL SCHEMATIC DIAGRAM

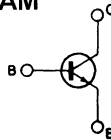

MECHANICAL DATA

Dimensions in mm

Collector connected to case

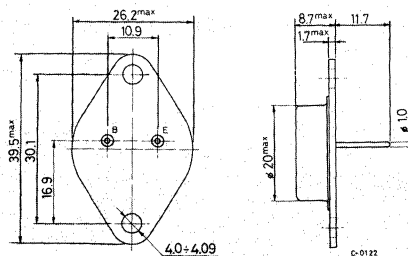

TO-3



THERMAL DATA

$R_{th\ j-case}$	Thermal resistance junction-case	max	1.4	$^{\circ}C/W$
------------------	----------------------------------	-----	-----	---------------

ELECTRICAL CHARACTERISTICS ($T_{case} = 25^{\circ}C$ unless otherwise specified)

Parameter	Test conditions	Min.	Typ.	Max.	Unit
I_{CBO} Collector cutoff current ($I_E = 0$)	for BDW51 $V_{CB} = 45V$ for BDW51A $V_{CB} = 60V$ for BDW51B $V_{CB} = 80V$ for BDW51C $V_{CB} = 100V$ $T_{case} = 150^{\circ}C$ for BDW51 $V_{CB} = 45V$ for BDW51A $V_{CB} = 60V$ for BDW51B $V_{CB} = 80V$ for BDW51C $V_{CB} = 100V$			500 500 500 500 5 5 5 5	μA μA μA μA mA mA mA mA
I_{CEO} Collector cutoff current ($I_B = 0$)	for BDW51 $V_{CE} = 22V$ for BDW51A $V_{CE} = 30V$ for BDW51B $V_{CE} = 40V$ for BDW51C $V_{CE} = 50V$			1 1 1 1	mA mA mA mA
I_{EBO} Emitter cutoff current ($I_C = 0$)	$V_{EB} = 5V$			2	mA
$V_{CEO(sus)}^*$ Collector-emitter sustaining voltage ($I_B = 0$)	$I_C = 100\text{ mA}$ for BDW51 for BDW51A for BDW51B for BDW51C			45 60 80 100	V V V V
$V_{CE(sat)}^*$ Collector-emitter saturation voltage	$I_C = 5A$ $I_B = 0.5A$ $I_C = 10A$ $I_B = 2.5A$			1 3	V V
$V_{BE(sat)}^*$ Base-emitter saturation voltage	$I_C = 10A$ $I_B = 2.5A$			2.5	V
V_{BE}^* Base-emitter voltage	$I_C = 5A$ $V_{CE} = 4V$			1.5	V
h_{FE}^* DC current gain	$I_C = 5A$ $V_{CE} = 4V$ $I_C = 10A$ $V_{CE} = 4V$			20 5	— —
f_T Transition frequency	$I_C = 0.5A$ $V_{CE} = 4V$			3	MHz

* Pulsed: pulse duration = 300 μs , duty cycle = 1.5%

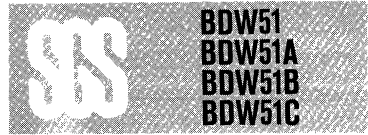

Safe operating areas
(for **BDW51** and **BDW51A**)

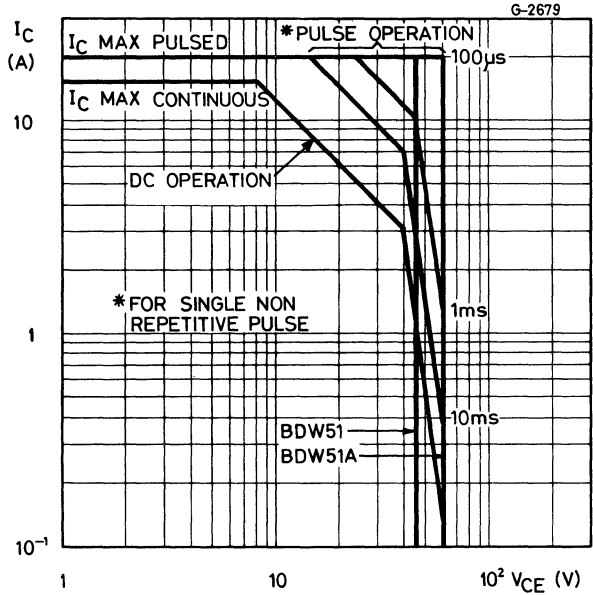

Safe operating areas
(for **BDW51B** and **BDW51C**)

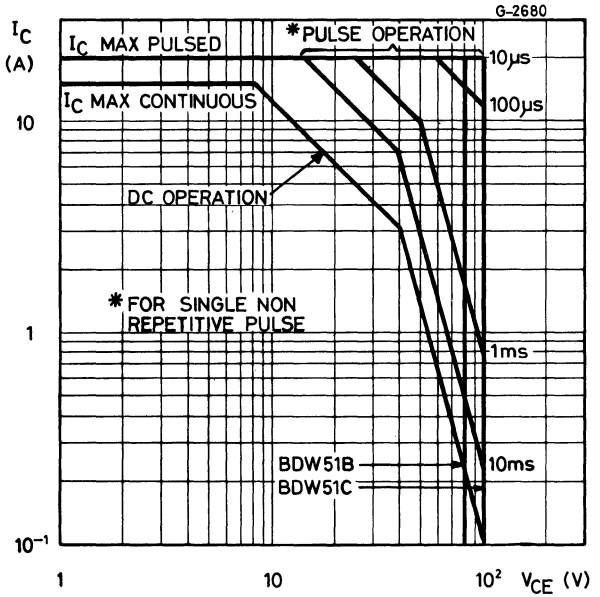

DC current gain

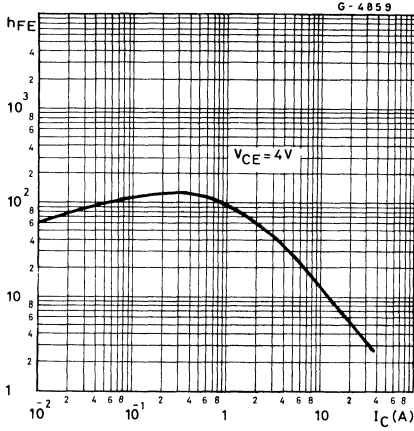

DC transconductance

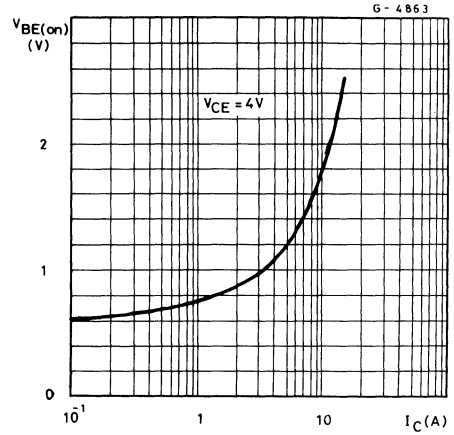

Collector-emitter saturation voltage

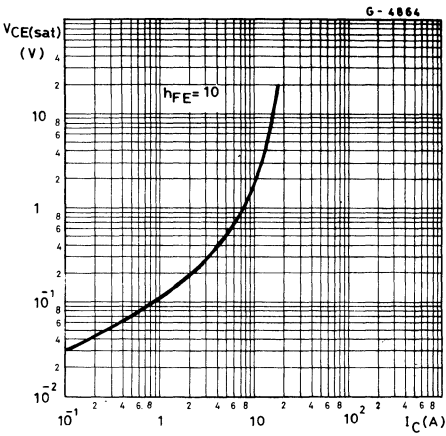

Base-emitter saturation voltage

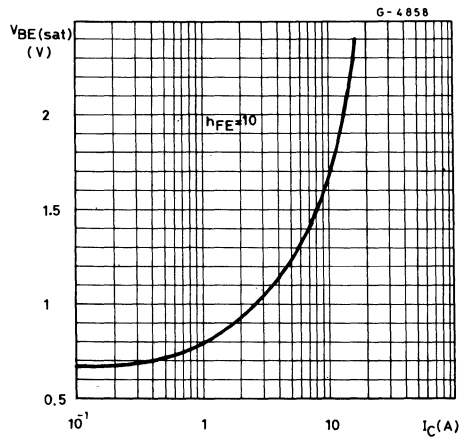

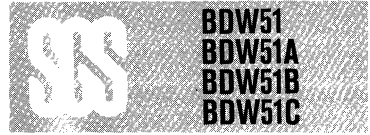

Collector-base capacitance

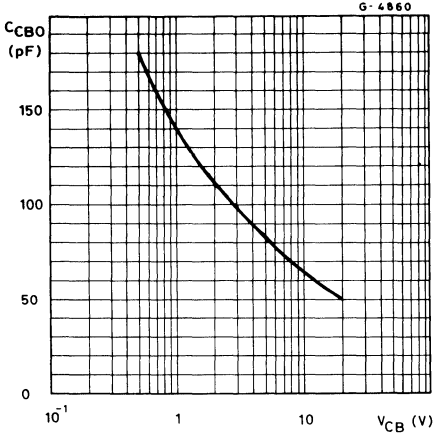

Transition frequency

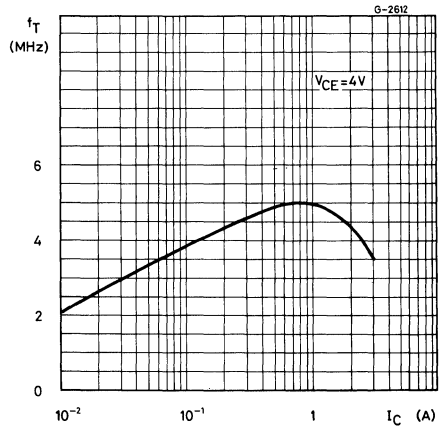

Saturated switching characteristics

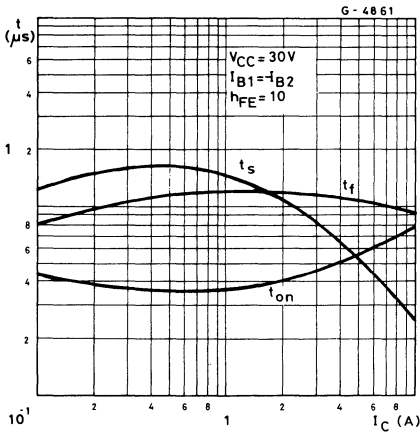

Power rating chart

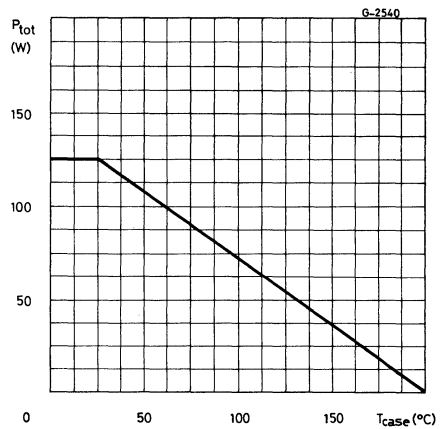

POWER LINEAR AND SWITCHING APPLICATIONS

The BDW 52, BDW 52A, BDW 52B and BDW 52C are silicon epitaxial-base PNP power transistors in Jedec TO-3 metal case. They are intended for use in power linear and switching applications.

The complementary NPN types are the BDW 51, BDW 51A, BDW 51B and BDW 51C respectively.

ABSOLUTE MAXIMUM RATINGS

		BDW52	BDW52A	BDW52B	BDW52C
V_{CBO}	Collector-base voltage ($I_E = 0$)	-45V	-60V	-80V	-100V
V_{CES}	Collector-emitter voltage ($V_{BE} = 0$)	-45V	-60V	-80V	-100V
V_{CEO}	Collector-emitter voltage ($I_B = 0$)	-45V	-60V	-80V	-100V
V_{EBO}	Emitter-base voltage ($I_C = 0$)			-5V	
I_C	Collector current			-15A	
I_{CM}	Collector peak current			-20A	
I_B	Base current			-7A	
P_{tot}	Total power dissipation at $T_{case} \leq 25^\circ C$			125W	
T_{stg}	Storage temperature			-65 to 200°C	
T_j	Junction temperature			200°C	

INTERNAL SCHEMATIC DIAGRAM

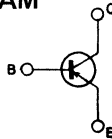

MECHANICAL DATA

Dimensions in mm

Collector connected to case

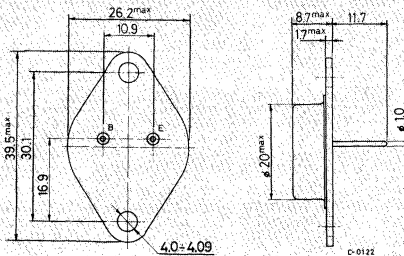

TO-3

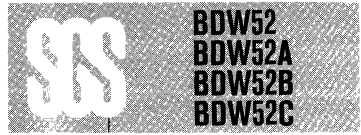

THERMAL DATA

$R_{th\ j-case}$	Thermal resistance junction-case	max	1.4 °C/W
------------------	----------------------------------	-----	----------

ELECTRICAL CHARACTERISTICS ($T_{case} = 25^{\circ}C$ unless otherwise specified)

Parameter	Test conditions	Min.	Typ.	Max.	Unit
I_{CBO} Collector cutoff current ($I_E = 0$)	for BDW52	$V_{CB} = -45V$		-500	μA
	for BDW52A	$V_{CB} = -60V$		-500	μA
	for BDW52B	$V_{CB} = -80V$		-500	μA
	for BDW52C	$V_{CB} = -100V$		-500	μA
	$T_{case} = 150^{\circ}C$				
	for BDW52	$V_{CB} = -45V$		-5	mA
	for BDW52A	$V_{CB} = -60V$		-5	mA
	for BDW52B	$V_{CB} = -80V$		-5	mA
for BDW52C	$V_{CB} = -100V$		-5	mA	
I_{CEO} Collector cutoff current ($I_B = 0$)	for BDW52	$V_{CE} = -22V$		-1	mA
	for BDW52A	$V_{CE} = -30V$		-1	mA
	for BDW52B	$V_{CE} = -40V$		-1	mA
	for BDW52C	$V_{CE} = -50V$		-1	mA
I_{EBO} Emitter cutoff current ($I_C = 0$)	$V_{EB} = -5 V$			-2	mA
$V_{CEO(sus)*}$ Collector-emitter sustaining voltage ($I_B = 0$)	$I_C = -100 mA$	for BDW52		-45	V
		for BDW52A		-60	V
		for BDW52B		-80	V
		for BDW52C		-100	V
$V_{CE(sat)*}$ Collector-emitter saturation voltage	$I_C = -5A$	$I_B = -0.5A$		-1	V
	$I_C = -10A$	$I_B = -2.5A$		-3	V
$V_{BE(sat)*}$ Base-emitter saturation voltage	$I_C = -10A$	$I_B = -2.5A$		-2.5	V
V_{BE*} Base-emitter voltage	$I_C = -5A$	$V_{CE} = -4V$		-1.5	V
h_{FE*} DC current gain	$I_C = -5A$	$V_{CE} = -4V$	20	150	—
	$I_C = -10A$	$V_{CE} = -4V$	5	—	—
f_T Transition frequency	$I_C = -0.5A$	$V_{CE} = -4V$	3		MHz

* Pulsed: pulse duration = 300 μs , duty cycle = 1.5%

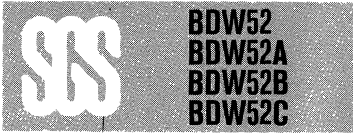

Safe operating areas
(for **BDW52** and **BDW52A**)

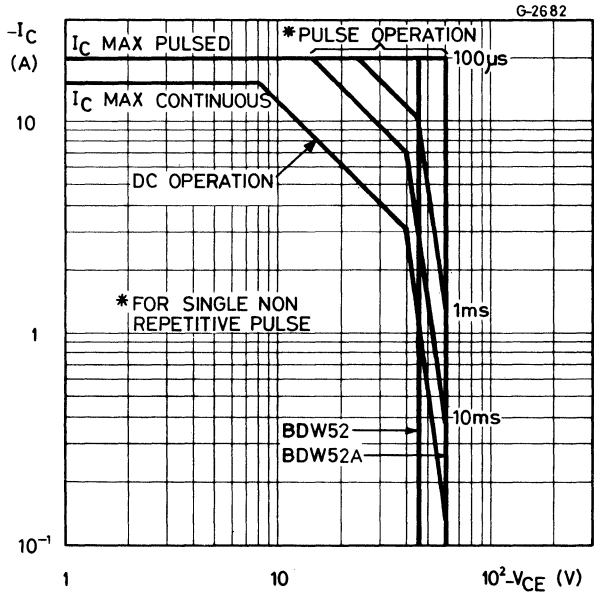

Safe operating areas
(for **BDW52B** and **BDW52C**)

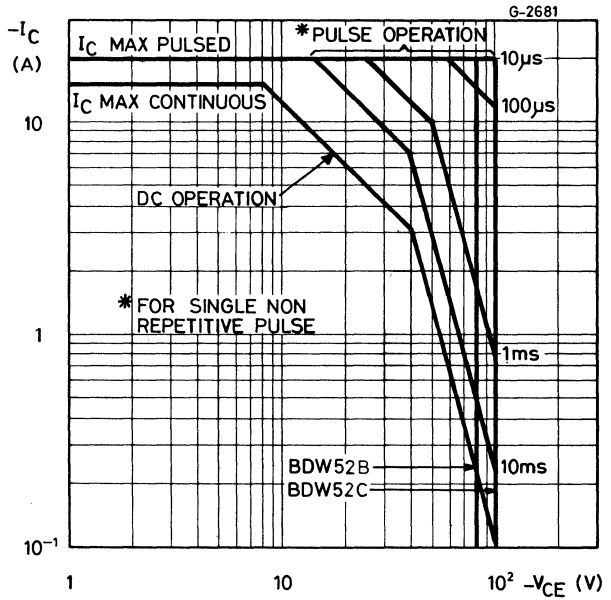

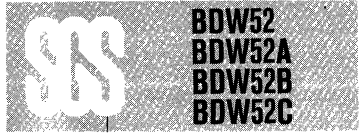

DC current gain

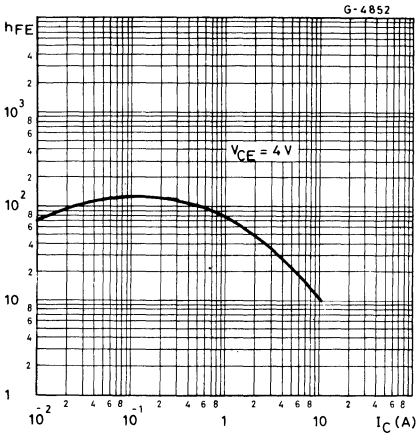

DC transconductance

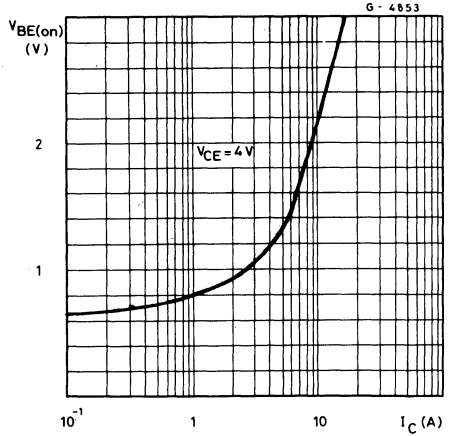

Collector-emitter saturation voltage

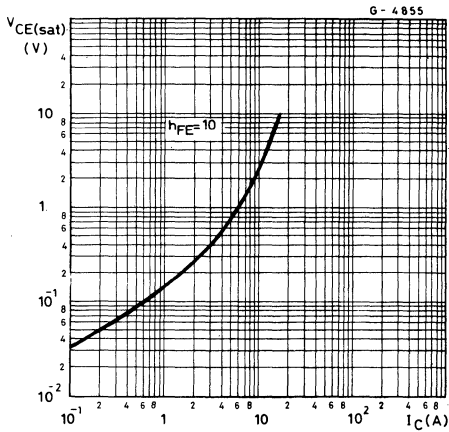

Base-emitter saturation voltage

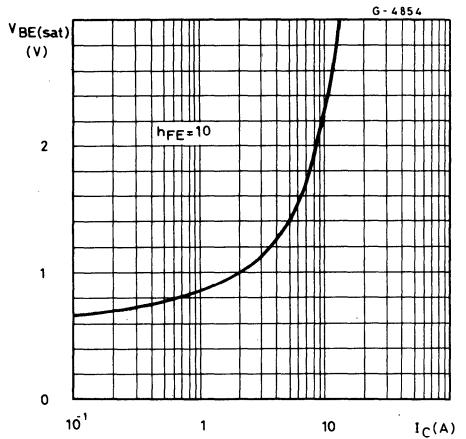

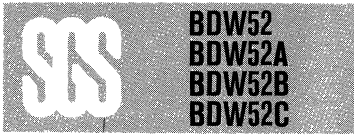

Collector-base capacitance

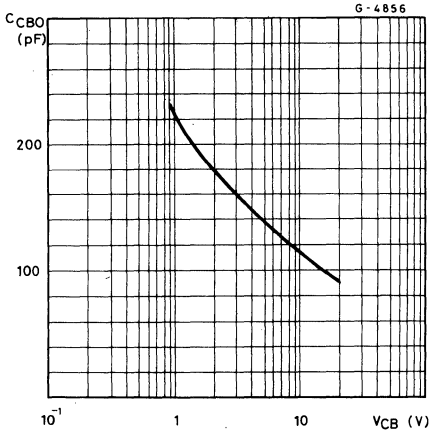

Transition frequency

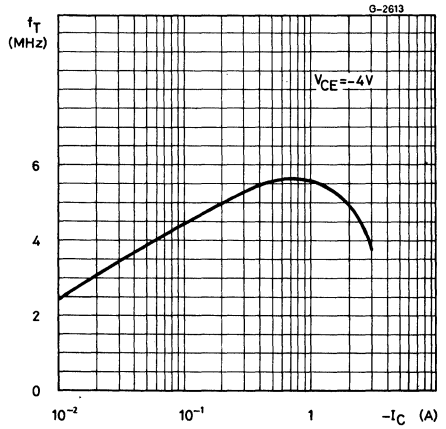

Saturated switching characteristics

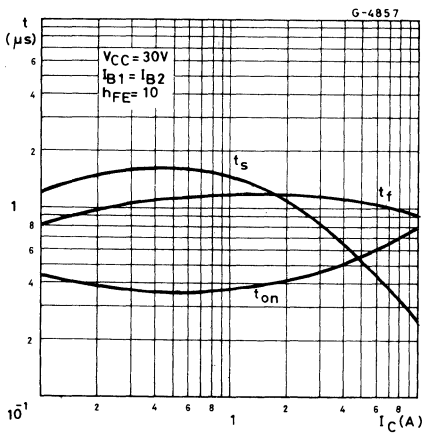

Power rating chart

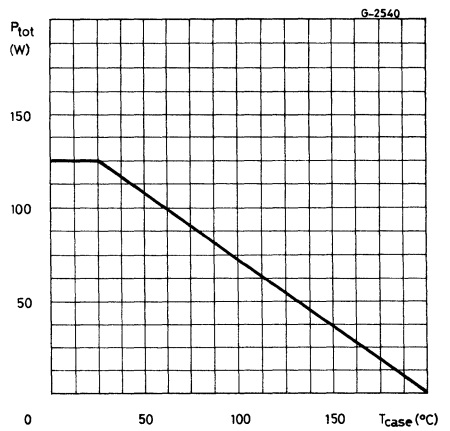

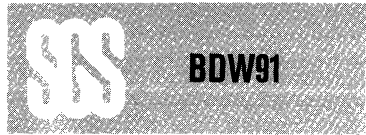

EPITAXIAL-BASE NPN

MEDIUM POWER DARLINGTON

The BDW 91 is a silicon epitaxial base NPN transistor in monolithic Darlington configuration mounted in Jedec TO-39 metal case. It is intended for use in switching and linear applications. The complementary PNP type is the BDW92.

ABSOLUTE MAXIMUM RATINGS

V_{CBO}	Collector-base voltage ($I_E = 0$)	180	V
V_{CEO}	Collector-emitter voltage ($I_B = 0$)	180	V
V_{EBO}	Emitter-base voltage ($I_C = 0$)	6	V
I_C	Collector current	4	A
I_B	Base current	100	mA
P_{tot}	Total power dissipation at $T_{case} \leq 25^\circ C$ $T_{amb} \leq 25^\circ C$	10	W
		1	W
T_{stg}	Storage temperature	-65 to 200	$^\circ C$
T_j	Junction temperature	200	$^\circ C$

INTERNAL SCHEMATIC DIAGRAM

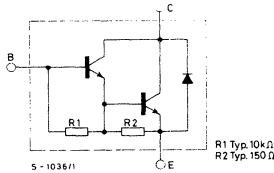

MECHANICAL DATA

Dimensions in mm

Collector connected to case

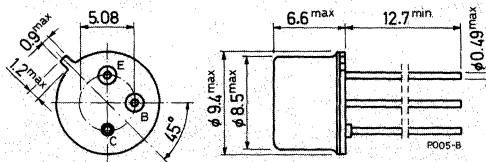

TO-39

**BDW91****THERMAL DATA**

$R_{th\ j-case}$	Thermal resistance junction-case	max	17.5	°C/W
$R_{th\ j-amb}$	Thermal resistance junction-ambient	max	175	°C/W

ELECTRICAL CHARACTERISTICS ($T_{case} = 25^{\circ}C$ unless otherwise specified)

Parameter	Test conditions	Min.	Typ.	Max.	Unit	
I_{CBO}	Collector cutoff current ($I_E = 0$)	$V_{CB} = 180V$		50	μA	
I_{CEO}	Collector cutoff current ($I_B = 0$)	$V_{CE} = 90V$		50	μA	
I_{EBO}	Emitter cutoff current ($I_C = 0$)	$V_{BE} = 6V$		0.4	2	mA
$V_{CEO(sus)}$	*Collector-emitter sustaining voltage	$I_C = 50\text{ mA}$		180	V	
$V_{CE(sat)}$	*Collector-emitter saturation voltage	$I_C = 2A$	$I_B = 4mA$	2	V	
V_{BE}	*Base-emitter voltage	$I_C = 2A$	$V_{CE} = 2V$	2.5	V	
h_{FE}	*DC current gain	$I_C = 2A$	$V_{CE} = 5V$	1000 3000	—	
		$I_C = 50mA$	$V_{CE} = 5V$	150 300	—	
V_F	*Parallel diode forward voltage	$I_F = 2A$		2.5	V	
h_{fe}	Small signal current gain	$I_C = 0.5A$	$V_{CE} = 2V$	20	—	
		$f = 1MHz$				

* Pulsed: pulse duration = 300 μ sec, duty cycle = 1%

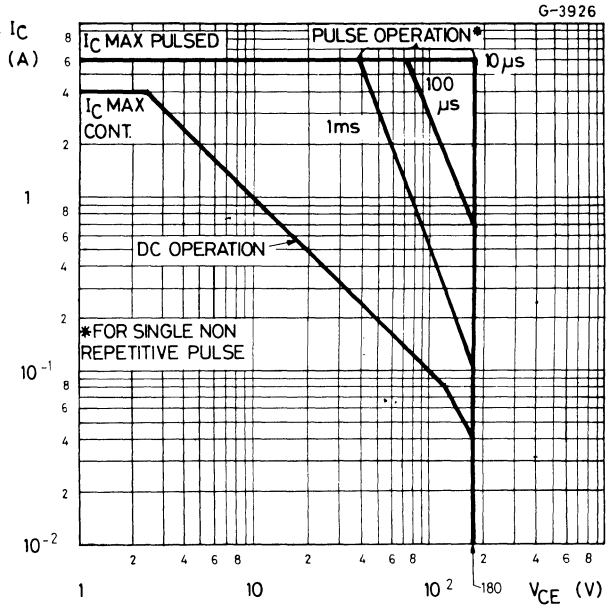
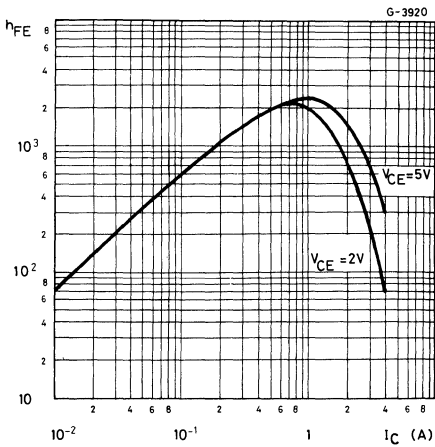
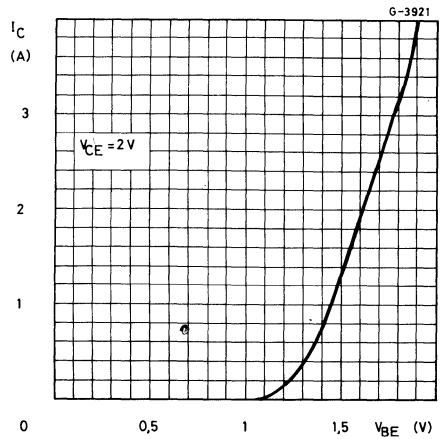
Safe operating areas

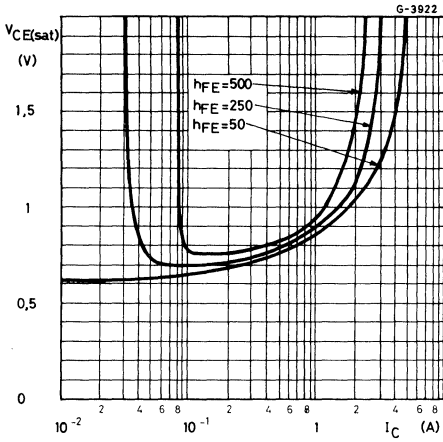
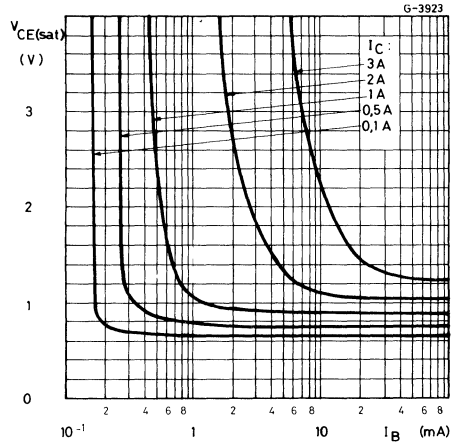
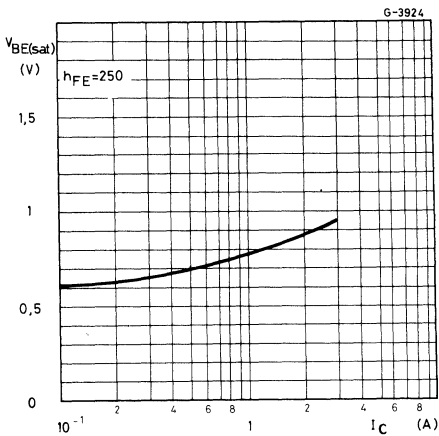
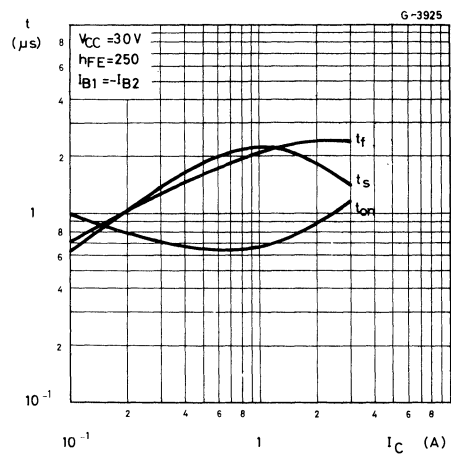
DC current gain

DC transconductance

Collector-emitter saturation voltage

Collector-emitter saturation voltage

Base-emitter saturation voltage

Saturated switching characteristics



EPITAXIAL-BASE PNP

MEDIUM POWER DARLINGTON

The BDW 92 is a silicon epitaxial base PNP transistor in monolithic Darlington configuration mounted in Jedec TO-39 metal case. It is intended for use in switching and linear applications.

The complementary NPN type is the BDW91.

ABSOLUTE MAXIMUM RATINGS

V_{CBO}	Collector-base voltage ($I_E = 0$)	-180	V
V_{CEO}	Collector-emitter voltage ($I_B = 0$)	-180	V
V_{EBO}	Emitter-base voltage ($I_C = 0$)	-6	V
I_C	Collector current	-4	A
I_B	Base current	-100	mA
P_{tot}	Total power dissipation at $T_{case} \leq 25^\circ C$ $T_{amb} \leq 25^\circ C$	10	W
		1	W
T_{stg}	Storage temperature	-65 to 200	$^\circ C$
T_j	Junction temperature	200	$^\circ C$

INTERNAL SCHEMATIC DIAGRAM

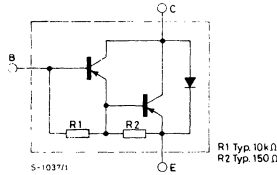

MECHANICAL DATA

Dimensions in mm

Collector connected to case

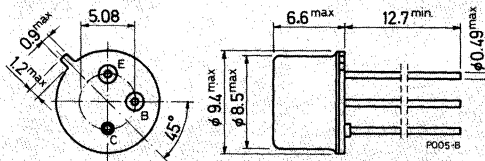

TO-39

**BDW92****THERMAL DATA**

$R_{th\ j-case}$	Thermal resistance junction-case	max	17.5	°C/W
$R_{th\ j-amb}$	Thermal resistance junction-ambient	max	175	°C/W

ELECTRICAL CHARACTERISTICS ($T_{case} = 25^{\circ}C$ unless otherwise specified)

Parameter	Test conditions	Min.	Typ.	Max.	Unit
I_{CBO}	Collector cutoff current ($I_E = 0$)			-50	μA
I_{CEO}	Collector cutoff current ($I_B = 0$)			-50	μA
I_{EBO}	Emitter cutoff current ($I_C = 0$)	-0.4		-2	mA
$V_{CEO(sus)}$	*Collector-emitter sustaining voltage	-180			V
$V_{CE(sat)}$	*Collector-emitter saturation voltage	$I_C = -2A$	$I_B = -4mA$	-2	V
V_{BE}	*Base-emitter voltage	$I_C = -2A$	$V_{CE} = -2V$	-2.5	V
h_{FE}	DC current gain	$I_C = -2A$ $I_C = -50mA$	$V_{CE} = -5V$ $V_{CE} = -5V$	1000 3000 150 300	— —
V_F	*Parallel diode forward voltage	$I_F = -2A$		-2.5	V
h_{fe}	Small signal current gain	$I_C = -0.5A$ $f = 1MHz$	$V_{CE} = -2V$	20	—

* Pulsed: pulse duration = 300 μs , duty cycle = 1%

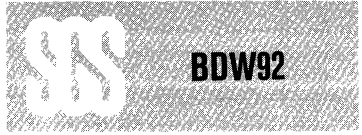

Safe operating areas

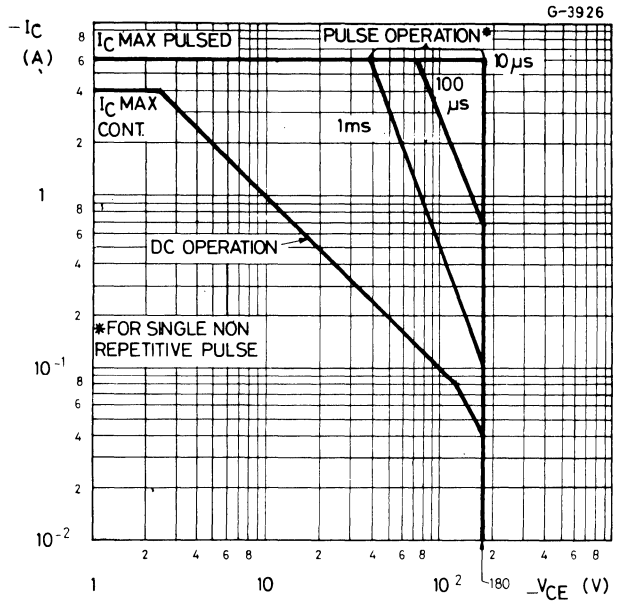

DC current gain

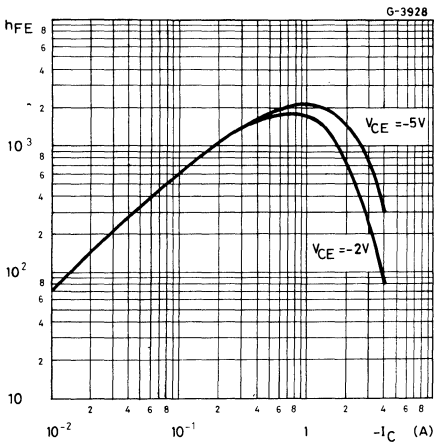

DC transconductance

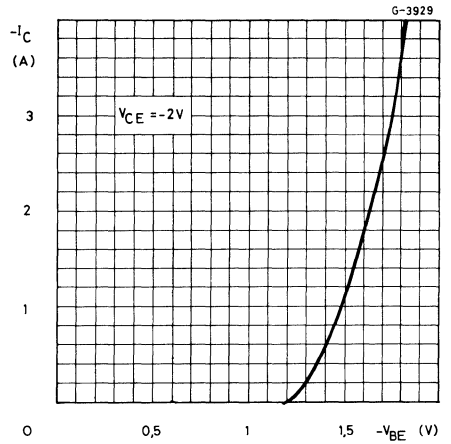

Collector-emitter saturation voltage

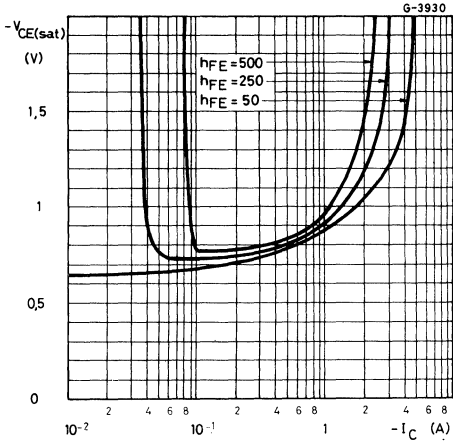

Collector-emitter saturation voltage

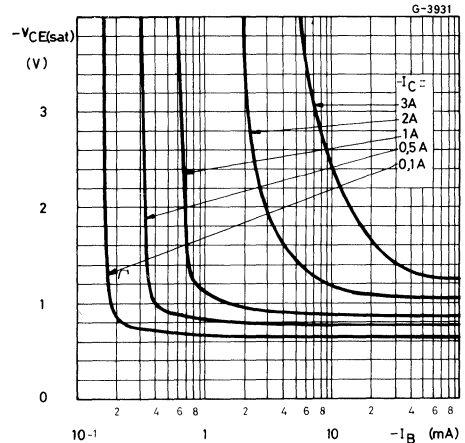

Base-emitter saturation voltage

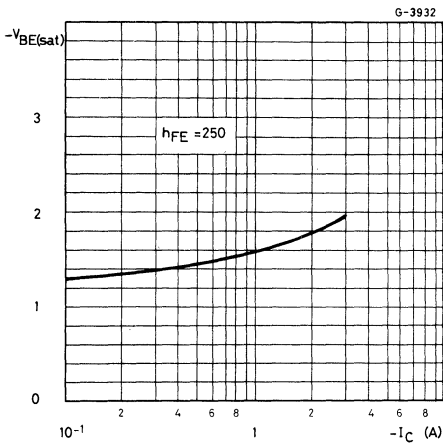

Saturated switching characteristics

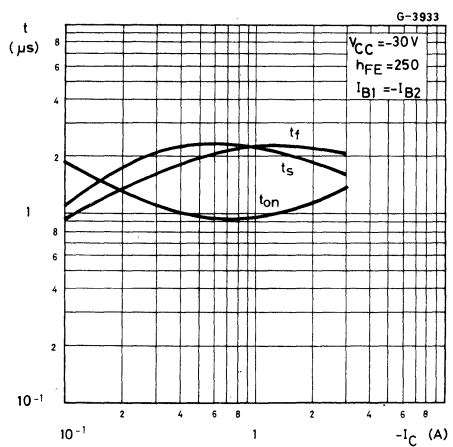

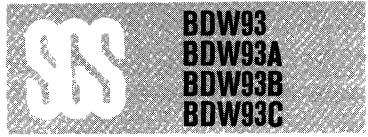

EPITAXIAL-BASE NPN

POWER DARLINGTONS

The BDW 93, BDW 93A, BDW 93B and BDW 93C are silicon epitaxial-base NPN transistors in monolithic Darlington configuration and are mounted in Jedec TO-220 plastic package. They are intended for use in power linear and switching applications. The complementary PNP types are the BDW 94, BDW 94A, BDW 94B and BDW 94C respectively.

ABSOLUTE MAXIMUM RATINGS

		BDW93	BDW93A	BDW93B	BDW93C
V_{CBO}	Collector-base voltage ($I_E = 0$)	45V	60V	80V	100V
V_{CEO}	Collector-emitter voltage ($I_B = 0$)	45V	60V	80V	100V
I_C	Collector current			12A	
I_{CM}	Collector peak current			15A	
I_B	Base current			0.2A	
P_{tot}	Total power dissipation at $T_{case} \leq 25^\circ C$			80W	
T_{stg}	Storage temperature			-65 to 150°C	
T_j	Junction temperature			150°C	

INTERNAL SCHEMATIC DIAGRAM

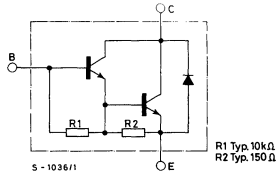

MECHANICAL DATA

Dimensions in mm

Collector connected to tab.

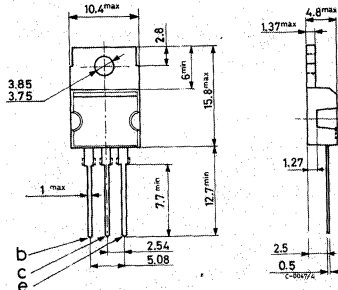

TO-220



THERMAL DATA

$R_{th\ j-case}$	Thermal resistance junction-case	max	1.56	°C/W
------------------	----------------------------------	-----	------	------

ELECTRICAL CHARACTERISTICS ($T_{case} = 25^{\circ}C$ unless otherwise specified)

Parameter	Test conditions	Min.	Typ.	Max.	Unit.	
I_{CBO} Collector cutoff current ($I_E = 0$)	for BDW93	$V_{CB} = 45V$		100	μA	
	for BDW93A	$V_{CB} = 60V$		100	μA	
	for BDW93B	$V_{CB} = 80V$		100	μA	
	for BDW93C	$V_{CB} = 100V$		100	μA	
	$T_{case} = 150^{\circ}C$					
	for BDW93	$V_{CB} = 45V$		5	mA	
	for BDW93A	$V_{CB} = 60V$		5	mA	
	for BDW93B	$V_{CB} = 80V$		5	mA	
for BDW93C	$V_{CB} = 100V$		5	mA		
I_{CEO} Collector cutoff current ($I_B = 0$)	for BDW93	$V_{CE} = 40V$		1	mA	
	for BDW93A	$V_{CE} = 60V$		1	mA	
	for BDW93B	$V_{CE} = 80V$		1	mA	
	for BDW93C	$V_{CE} = 80V$		1	mA	
I_{EBO} Emitter cutoff current ($I_C = 0$)	$V_{EB} = 5V$			2	mA	
$V_{CEO(sus)}$ * Collector-emitter sustaining voltage ($I_B = 0$)	$I_C = 100mA$ for BDW93 for BDW93A for BDW93B for BDW93C		45		V	
			60		V	
			80		V	
			100		V	
$V_{CE(sat)}$ * Collector-emitter saturation voltage	$I_C = 5A$ $I_C = 10A$	$I_B = 20mA$ $I_B = 100mA$		2	V	
				3	V	
$V_{BE(sat)}$ * Base-emitter saturation voltage	$I_C = 5A$ $I_C = 10A$	$I_B = 20mA$ $I_B = 100mA$		2.5	V	
				4	V	
h_{FE} * DC current gain	$I_C = 3A$ $I_C = 5A$ $I_C = 10A$	$V_{CE} = 3V$ $V_{CE} = 3V$ $V_{CE} = 3V$	1000		—	
			750	20000	—	
			100		—	
V_F * Parallel-diode forward voltage	$I_F = 5A$ $I_F = 10A$		1.3	2	V	
			1.8	4	V	
h_{fe} Small signal current gain	$I_C = 1A$ $f = 1\text{ MHz}$	$V_{CE} = 10V$	20		—	

* Pulsed: pulse duration = 300 μs , duty cycle = 1.5%

Safe operating areas
(for **BDW93** and **BDW93A**)

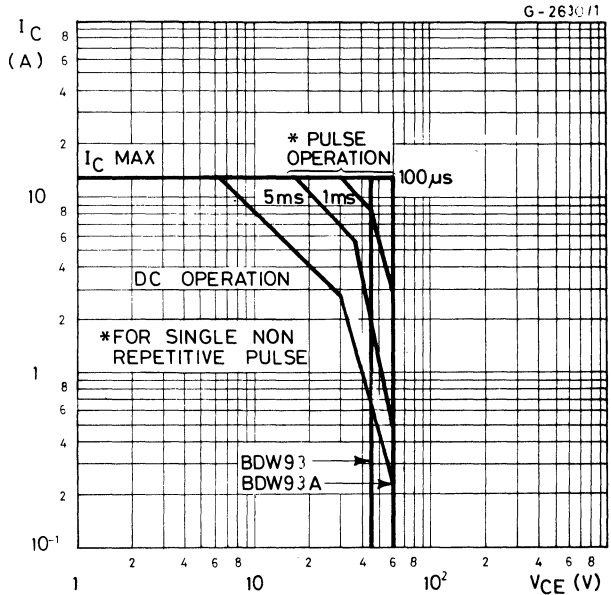

Safe operating areas
(for **BDW93B** and **BDW93C**)

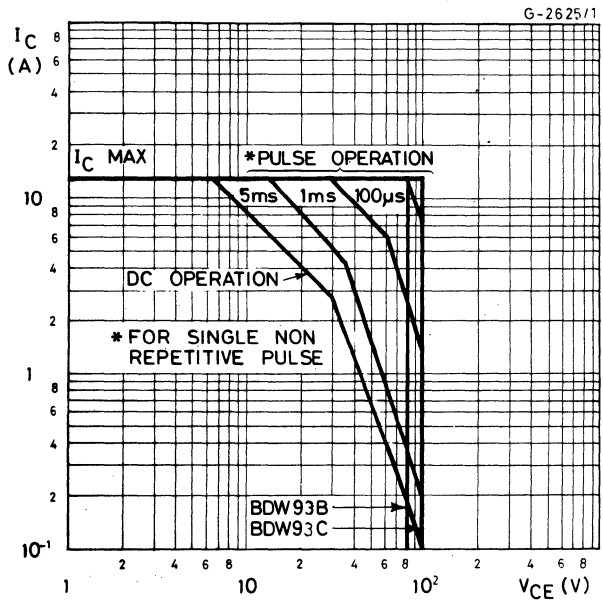

DC current gain

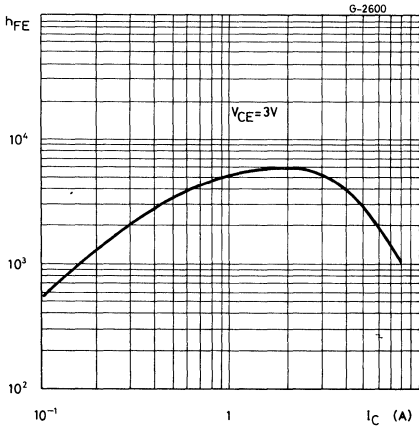

DC transconductance

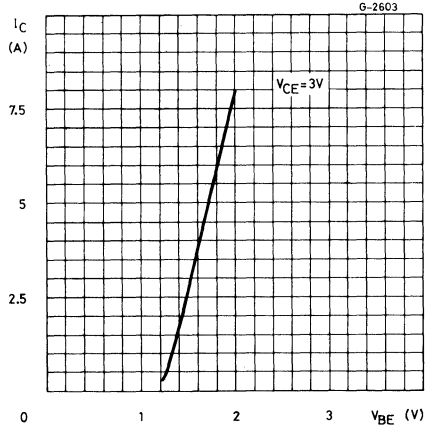

Collector-emitter saturation voltage

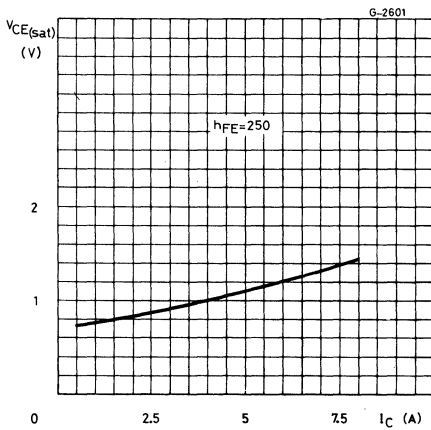

Collector-emitter saturation voltage

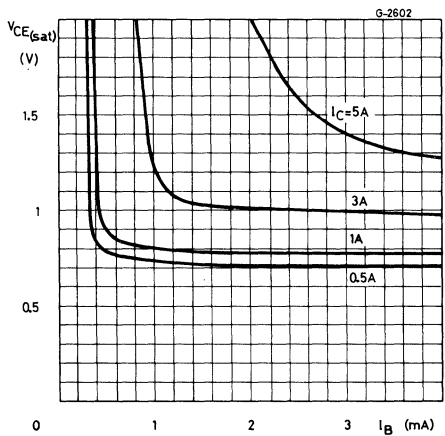

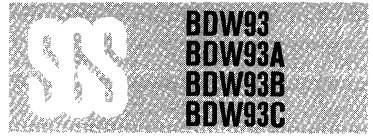

Small signal current gain

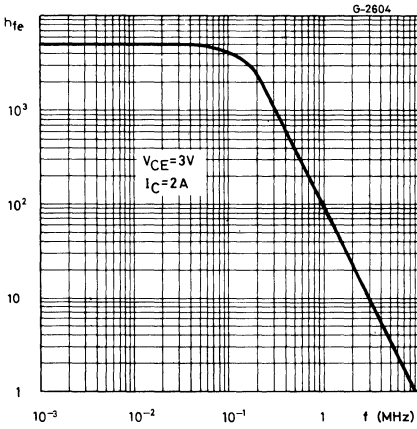

Collector-base capacitance

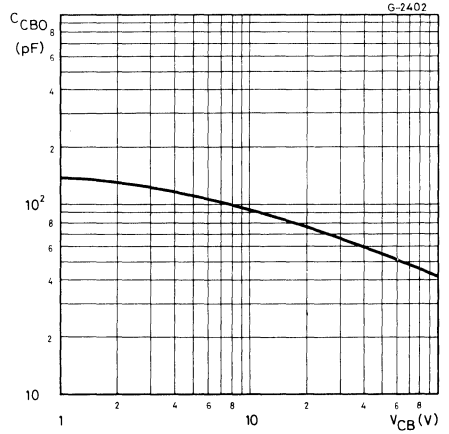

Saturated switching characteristics

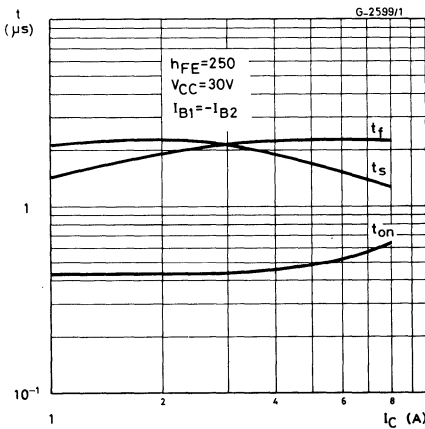

Power rating chart

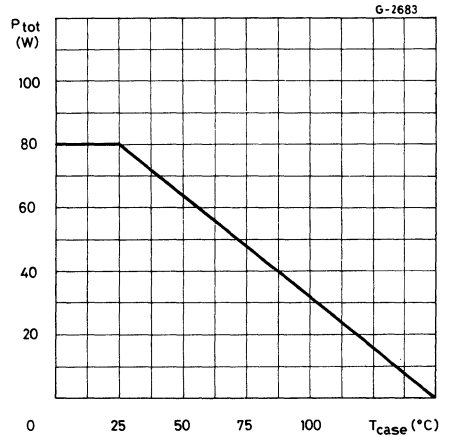

POWER DARLINGTONS

The BDW 94, BDW 94A, BDW 94B and BDW 94C are silicon epitaxial-base PNP transistors in monolithic Darlington configuration and are mounted in Jedec TO-220 plastic package. They are intended for use in power linear and switching applications. The complementary NPN types are the BDW 93, BDW 93A, BDW 93B and BDW 93C respectively.

ABSOLUTE MAXIMUM RATINGS

		BDW94	BDW94A	BDW94B	BDW94C
V_{CBO}	Collector-base voltage ($I_E = 0$)	-45V	-60V	-80V	-100V
V_{CEO}	Collector-emitter voltage ($I_B = 0$)	-45V	-60V	-80V	-100V
I_C	Collector current			-12A	
I_{CM}	Collector peak current			-15A	
I_B	Base current			-0.2A	
P_{tot}	Total power dissipation at $T_{case} \leq 25^\circ C$			80W	
T_{stg}	Storage temperature			-65 to $150^\circ C$	
T_j	Junction temperature			$150^\circ C$	

INTERNAL SCHEMATIC DIAGRAM

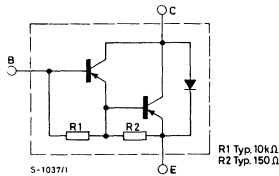

MECHANICAL DATA

Dimensions in mm

Collector connected to tab.

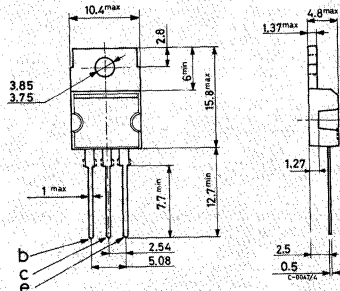

TO-220

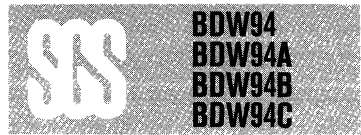

THERMAL DATA

$R_{th\ j-case}$	Thermal resistance junction-case	max	1.56	°C/W
------------------	----------------------------------	-----	------	------

ELECTRICAL CHARACTERISTICS ($T_{case} = 25^{\circ}C$ unless otherwise specified)

Parameter	Test conditions	Min.	Typ.	Max.	Unit
I_{CBO}	Collector cutoff current ($I_E = 0$)	for BDW94 for BDW94A for BDW94B for BDW94C	$V_{CB} = -45V$ $V_{CB} = -60V$ $V_{CB} = -80V$ $V_{CB} = -100V$	-100 -100 -100 -100	μA μA μA μA
		$T_{case} = 150^{\circ}C$ for BDW94 for BDW94A for BDW94B for BDW94C	$V_{CB} = -45V$ $V_{CB} = -60V$ $V_{CB} = -80V$ $V_{CB} = -100V$	-5 -5 -5 -5	mA mA mA mA
I_{CEO}	Collector cutoff current ($I_B = 0$)	for BDW94 for BDW94A for BDW94B for BDW94C	$V_{CE} = -40V$ $V_{CE} = -60V$ $V_{CE} = -80V$ $V_{CE} = -80V$	-1 -1 -1 -1	mA mA mA mA
I_{EBO}	Emitter cutoff current ($I_C = 0$)	$V_{EB} = -5V$		-2	mA
$V_{CEO(sus)}$ *	Collector-emitter sustaining voltage ($I_B = 0$)	$I_C = -100mA$ for BDW94 for BDW94A for BDW94B for BDW94C		-45 -60 -80 -100	V V V V
$V_{CE(sat)}$ *	Collector-emitter saturation voltage	$I_C = -5A$	$I_B = -20mA$	-2	V
		$I_C = -10A$	$I_B = -100mA$	-3	V
$V_{BE(sat)}$ *	Base-emitter saturation voltage	$I_C = -5A$	$I_B = -20mA$	-2.5	V
		$I_C = -10A$	$I_B = -100mA$	-4	V
h_{FE} *	DC current gain	$I_C = -3A$	$V_{CE} = -3V$	1000	—
		$I_C = -5A$	$V_{CE} = -3V$	750	20000
		$I_C = -10A$	$V_{CE} = -3V$	100	—
V_F *	Parallel-diode forward voltage	$I_F = 5A$		1.3	2
		$I_F = 10A$		1.8	4
h_{ie}	Small signal current gain	$I_C = -1A$ $f = 1\text{ MHz}$	$V_{CE} = -10V$	20	—

* Pulsed: pulse duration = 300 μs , duty cycle = 1.5%

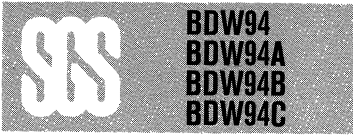

Safe operating areas
(for **BDW94** and **BDW94A**)

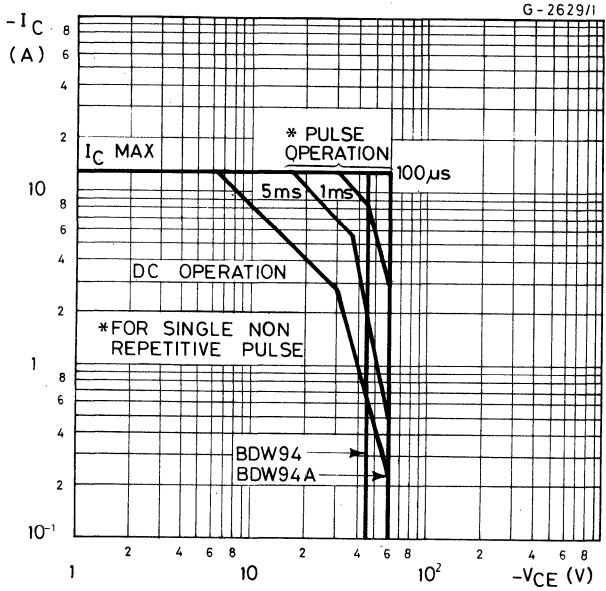

Safe operating areas
(for **BDW94B** and **BDW94C**)

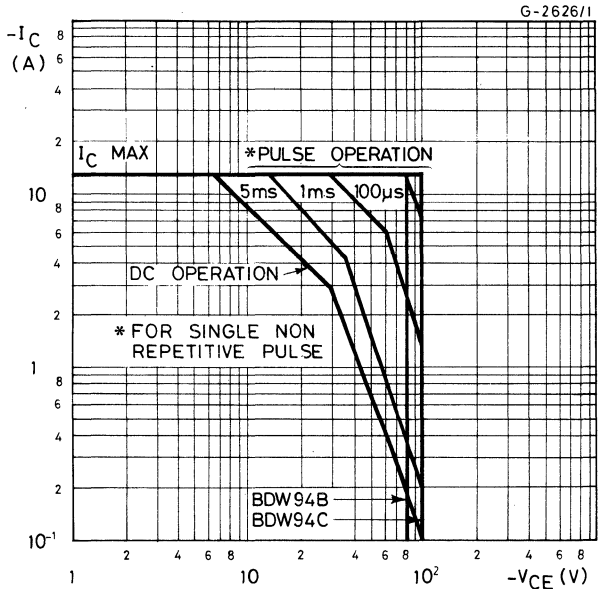

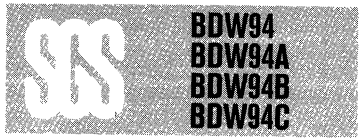

DC current gain

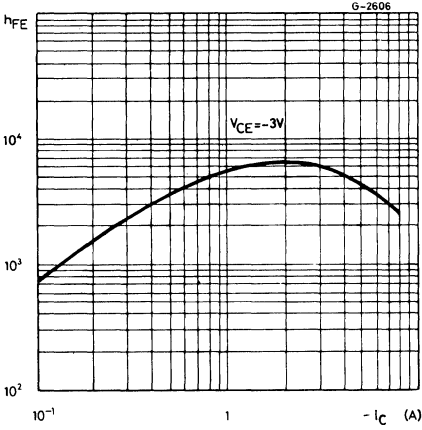

DC transconductance

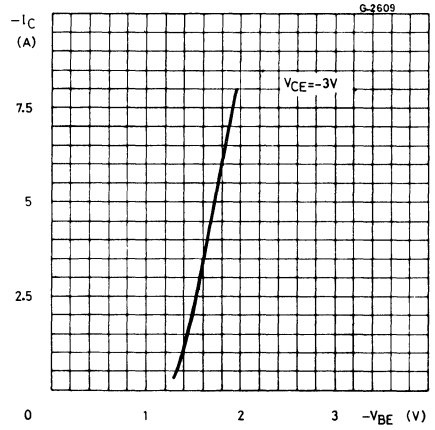

Collector-emitter saturation voltage

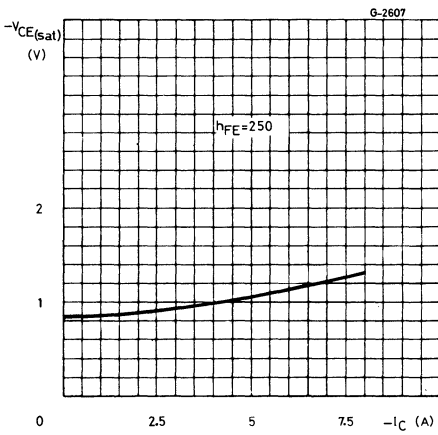

Collector-emitter saturation voltage

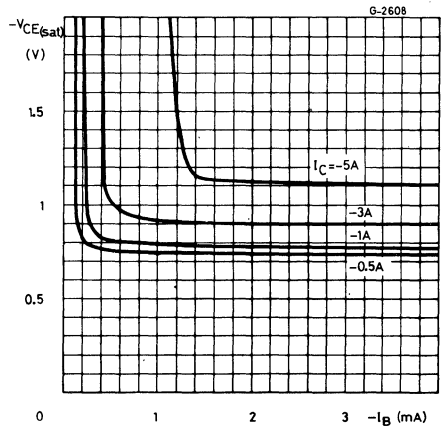

Small signal current gain

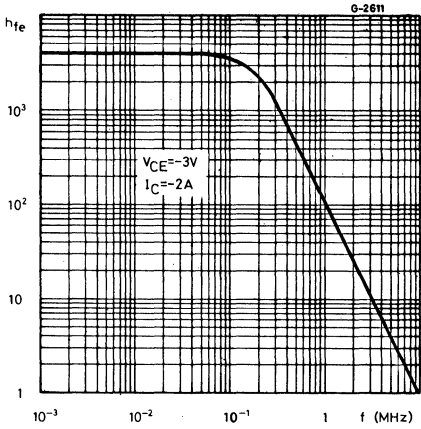

Collector-base capacitance

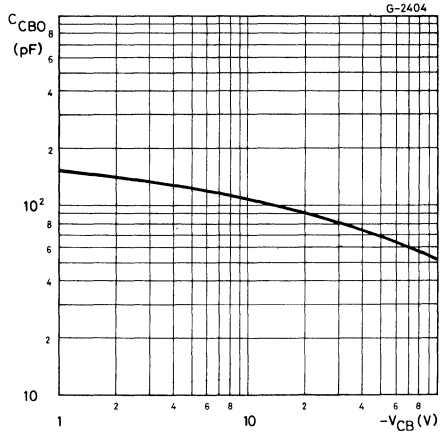

Saturated switching characteristics

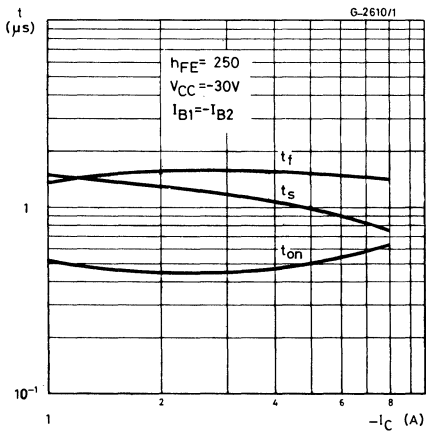

Power rating chart

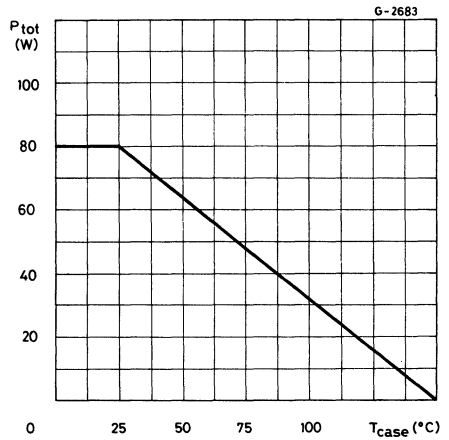

EPITAXIAL-BASE NPN

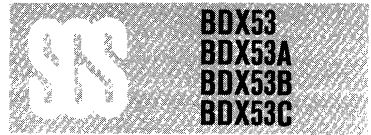

POWER DARLINGTONS

The BDX 53, BDX 53A, BDX 53B and BDX 53C are silicon epitaxial-base NPN transistors in monolithic Darlington configuration and are mounted in Jedec TO-220 plastic package, intended for use in hammer drivers, audio amplifiers and other medium power linear and switching applications.

The complementary PNP types are the BDX 54, BDX 54A, BDX 54B and BDX 54C respectively.

ABSOLUTE MAXIMUM RATINGS

	BDX53	BDX53A	BDX53B	BDX53C
V_{CBO}	45V	60V	80V	100V
V_{CEO}	45V	60V	80V	100V
V_{EBO}			5V	
I_C			8A	
I_{CM}			12A	
I_B			0.2A	
P_{tot}			60W	
T_{stg}			-65 to 150°C	
T_j			150 °C	

INTERNAL SCHEMATIC DIAGRAM

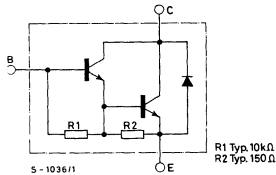

MECHANICAL DATA

Dimensions in mm

Collector connected to tab.

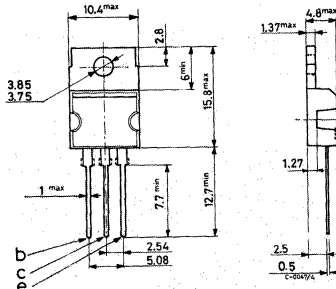

TO-220



THERMAL DATA

$R_{th\ j-case}$	Thermal resistance junction-case	max	2.08	°C/W
$R_{th\ j-amb}$	Thermal resistance junction-ambient	max	70	°C/W

ELECTRICAL CHARACTERISTICS ($T_{case} = 25^{\circ}C$ unless otherwise specified)

Parameter	Test conditions	Min.	Typ.	Max.	Unit
I_{CBO}	Collector cutoff current ($I_E = 0$)	for BDX53 for BDX53A for BDX53B for BDX53C	$V_{CB} = 45V$ $V_{CB} = 60V$ $V_{CB} = 80V$ $V_{CB} = 100V$	200 200 200 200	μA μA μA μA
I_{CEO}	Collector cutoff current ($I_B = 0$)	for BDX53 for BDX53A for BDX53B for BDX53C	$V_{CE} = 22V$ $V_{CE} = 30V$ $V_{CE} = 40V$ $V_{CE} = 50V$	500 500 500 500	μA μA μA μA
I_{EBO}	Emitter cutoff current ($I_C = 0$)	$V_{EB} = 5V$		2	mA
$V_{CEO(sus)}^*$	Collector-emitter sustaining voltage ($I_B = 0$)	$I_C = 100\text{ mA}$		45 60 80 100	V V V V
$V_{CE(sat)}^*$	Collector-emitter saturation voltage	$I_C = 3A$	$I_B = 12\text{ mA}$	2	V
$V_{BE(sat)}^*$	Base-emitter saturation voltage	$I_C = 3A$	$I_B = 12\text{ mA}$	2.5	V
h_{FE}^*	DC current gain	$I_C = 3A$	$V_{CE} = 3V$	750	—
V_F	Parallel-diode forward voltage	$I_F = 3A$ $I_F = 8A$		1.8 2.5 2.5	V V V

* Pulsed: pulse duration = 300 μs , duty cycle = 1.5%

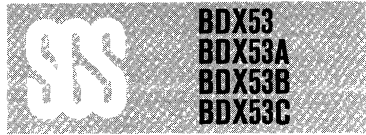

Safe operating areas

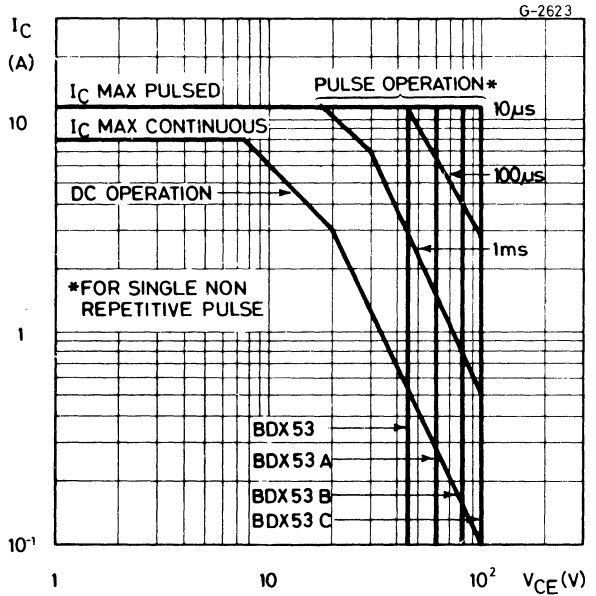

DC current gain

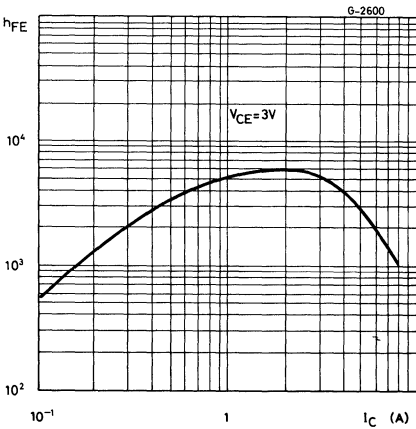

DC transconductance

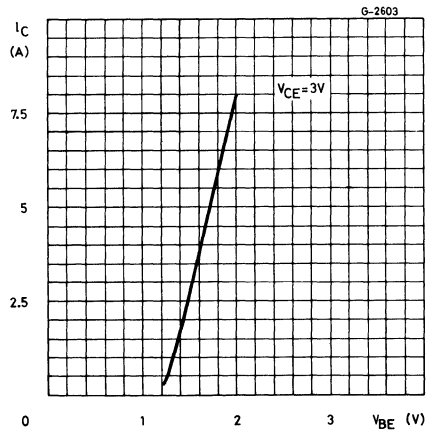



Collector-emitter saturation voltage

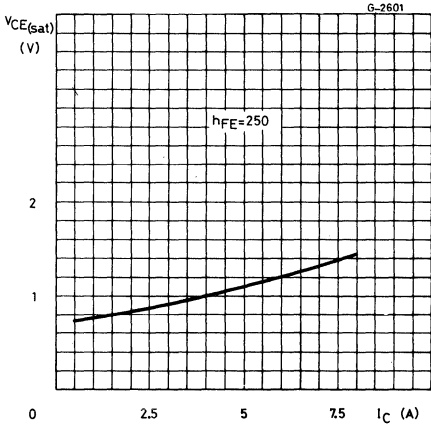

Collector-emitter saturation voltage

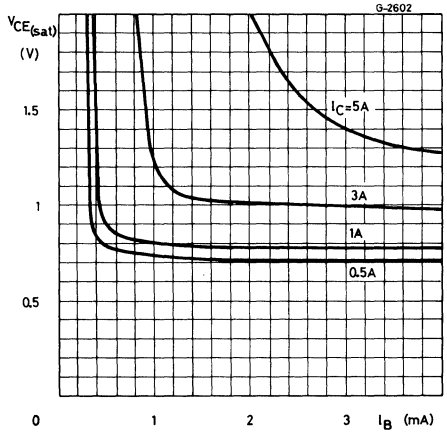

Small signal current gain

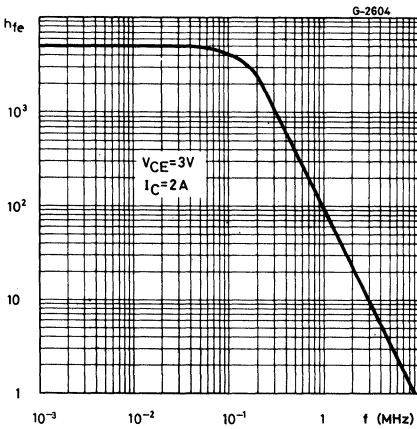

Saturated switching characteristics

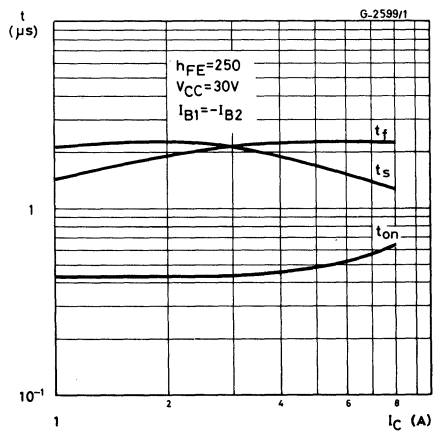

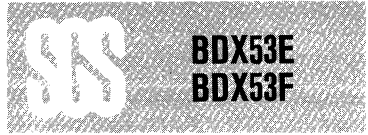

EPITAXIAL-BASE NPN

POWER DARLINGTONS

The BDX 53E, BDX 53F are silicon epitaxial base NPN transistors in monolithic Darlington configuration and are mounted in Jedec TO-220 plastic package. They are intended for use in power linear and switching applications. The complementary PNP types are the BDX 54E and BDX 54F respectively.

ABSOLUTE MAXIMUM RATINGS

		BDX53E	BDX53F
V_{CBO}	Collector-base voltage ($I_E=0$)	140V	160V
V_{CEO}	Collector-emitter voltage ($I_B=0$)	140V	160V
V_{EBO}	Emitter-base voltage ($I_C=0$)		5V
I_C	Collector current		8A
I_{CM}	Collector peak current		12A
I_B	Base current		0.2A
P_{tot}	Total power dissipation at $T_{case} \leq 25^\circ C$		60W
T_{stg}	Storage temperature		-65 to 150°C
T_j	Junction temperature		150°C

INTERNAL SCHEMATIC DIAGRAM

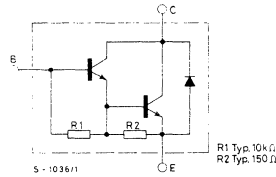

MECHANICAL DATA

Dimensions in mm

Collector connected to tab.

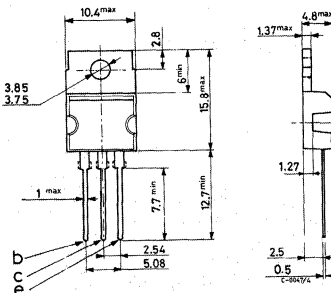

TO-220



BDX53E
BDX53F

THERMAL DATA

$R_{th\ j-case}$	Thermal resistance junction-case	max	2.08	°C/W
$R_{th\ j-amb}$	Thermal resistance junction-ambient	max	70	°C/W

ELECTRICAL CHARACTERISTICS ($T_{case} = 25^{\circ}C$ unless otherwise specified)

Parameter	Test conditions	Min.	Typ.	Max.	Unit
I_{CEO}	Collector cutoff current ($I_B = 0$)	for BDX53E for BDX53F	$V_{CE} = 70V$ $V_{CE} = 80V$	0.5 0.5	mA mA
I_{CBO}	Collector cutoff current ($I_E = 0$)	for BDX53E for BDX53F	$V_{CB} = 140V$ $V_{CB} = 160V$	0.2 0.2	mA mA
I_{EBO}	Emitter cutoff current ($I_E = 0$)	$V_{EB} = 5V$		5	mA
$V_{CEO(sus)}$	*Collector-emitter sustaining voltage ($I_B = 0$)	$I_C = 50\text{ mA}$ for BDX53E for BDX53F		140 160	V V
$V_{CE(sat)}$	* Collector-emitter saturation voltage	$I_C = 2A$	$I_B = 10mA$	2	V
$V_{BE(sat)}$	* Base-emitter saturation voltage	$I_C = 2A$	$I_B = 10mA$	2.5	V
h_{FE}	* DC current gain	$I_C = 2A$ $I_C = 3A$	$V_{CE} = 5V$ $V_{CE} = 5V$	500 150	— —
V_F	* Parallel diode forward voltage	$I_F = 2A$		2.5	V
h_{fe}	Small signal current gain	$I_C = 0.5A$ $f = 1MHz$	$V_{CE} = 2V$	20	—

* Pulsed: pulse duration = 300 μs , duty cycle = 1%

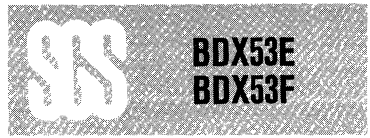

Safe operating areas

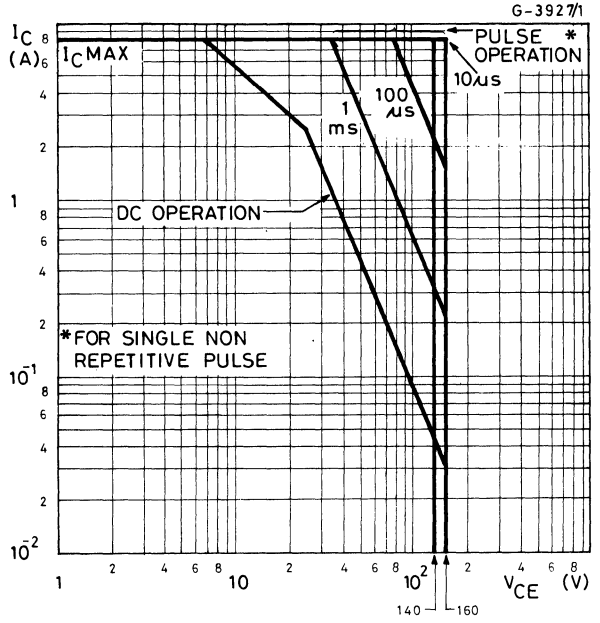

DC current gain

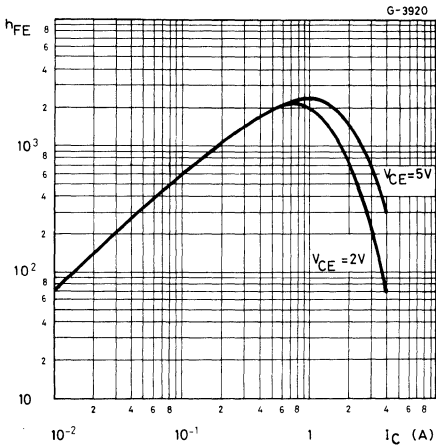

DC transconductance

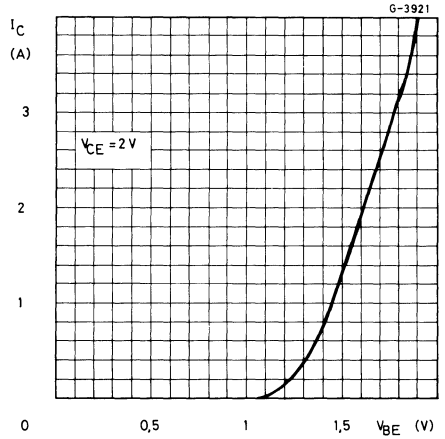

Collector-emitter saturation voltage

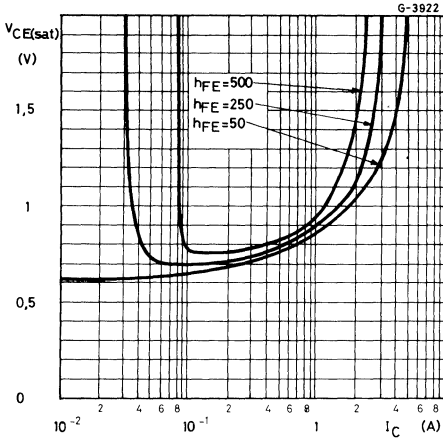

Collector-emitter saturation voltage

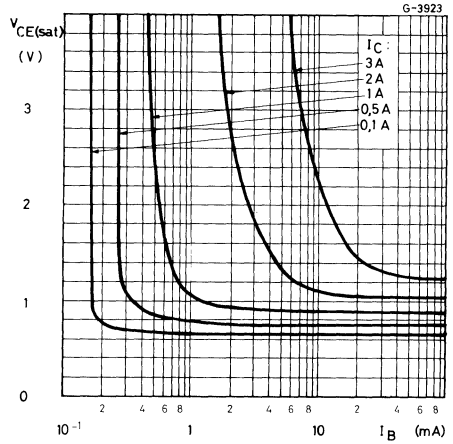

Base-emitter saturation voltage

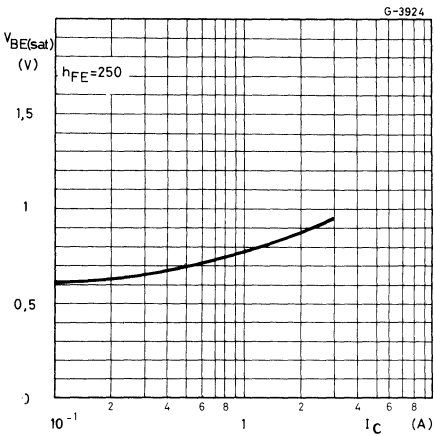

Saturated switching characteristics

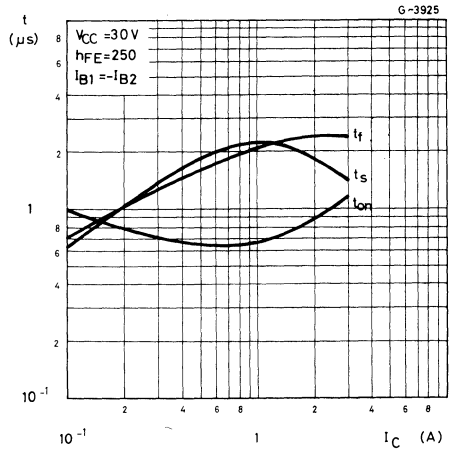



EPITAXIAL-BASE NPN

MEDIUM POWER DARLINGTON

The BDX53S is a silicon epitaxial-base NPN transistor in monolithic Darlingtion configuration and is mounted in Jedec TO-39 metal case.

It is intended for use in medium in power linear and switching applications. The complementary PNP type is the BDX54S

ABSOLUTE MAXIMUM RATINGS

V_{CBO}	Collector-base voltage ($I_E = 0$)	150	V
V_{CEO}	Collector-emitter voltage ($I_B = 0$)	150	V
V_{EBO}	Emitter-base voltage ($I_C = 0$)	5	V
I_C	Collector current	6	A
I_{CM}	Collector peak current	10	A
I_B	Base current	0.2	A
P_{tot}	Total power dissipation at $T_{case} \leq 25^\circ C$	15	W
		1	W
T_{stg}	Storage temperature	-65 to 200	$^\circ C$
T_j	Junction temperature	200	$^\circ C$

INTERNAL SCHEMATIC DIAGRAM

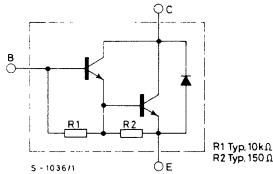

MECHANICAL DATA

Dimensions in mm

Collector connected to case

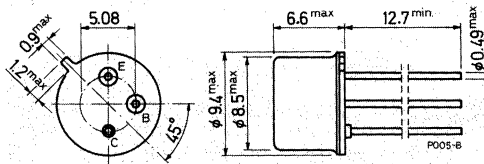

TO-39

**BDX53S****THERMAL DATA**

$R_{th\ j-case}$	Thermal resistance junction-case	max	11.66	°C/W
$R_{th\ j-amb}$	Thermal resistance junction-ambient	max	175	°C/W

ELECTRICAL CHARACTERISTICS ($T_{case} = 25^{\circ}C$ unless otherwise specified)

Parameter	Test conditions	Min.	Typ.	Max.	Unit
I_{CBO}	Collector cutoff current ($I_E = 0$)	$V_{CB} = 150V$ $T_{case} = 125^{\circ}C$ $V_{CB} = 150V$	0.2	2	mA
I_{CEO}	Collector cutoff current ($I_B = 0$)	$V_{CE} = 75V$	0.2		mA
I_{EBO}	Emitter cutoff current ($I_C = 0$)	$V_{EB} = 5V$	5		mA
$V_{CEO(sus)}$	*Collector-emitter sustaining voltage ($I_B = 0$)	$I_C = 50\text{ mA}$	150		V
$V_{CE(sat)}$	* Collector-emitter saturation voltage	$I_C = 2A$ $I_B = 8mA$	2		V
$V_{BE(sat)}$	* Base-emitter saturation voltage	$I_C = 2A$ $I_B = 8mA$	2.5		V
h_{FE}	DC current gain	$I_C = 100mA$ $V_{CE} = 5V$ $I_C = 2A$ $V_{CE} = 5V$	100 500		—
V_F	Parallel diode forward voltage	$I_F = 2A$	2.5		V
h_{fe}	Small signal current gain	$I_C = 0.5A$ $V_{CE} = 2V$ $f = 1\text{ MHz}$	20		—

* Pulsed: pulse duration = 300 μs , duty cycle = 1%

Safe operating area

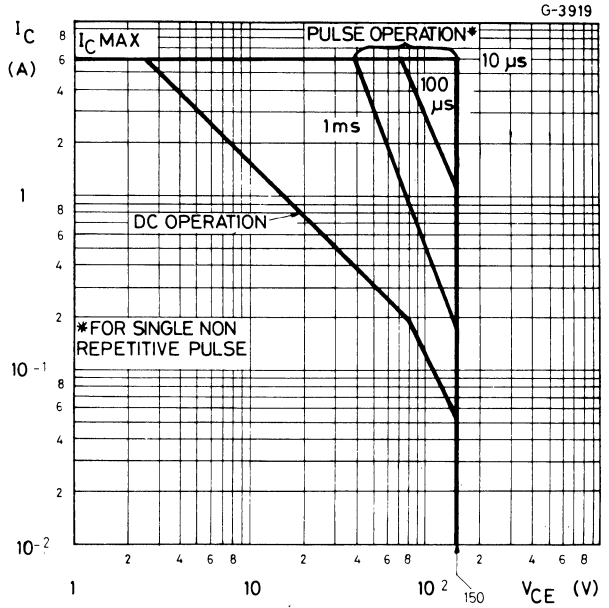

DC current gain

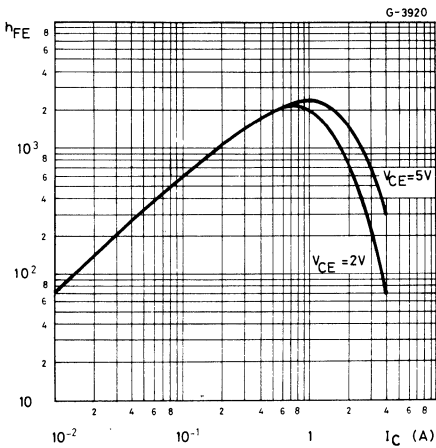

DC transconductance

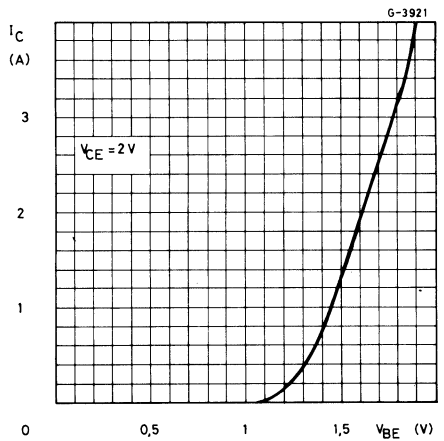

Collector-emitter saturation voltage

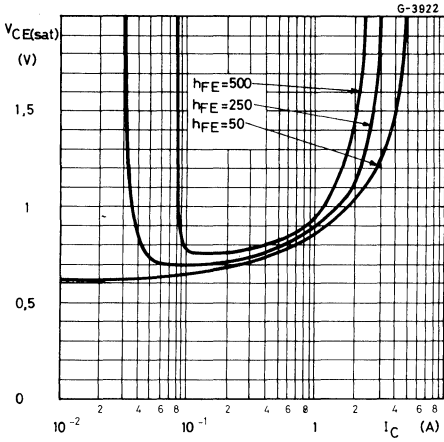

Collector-emitter saturation voltage

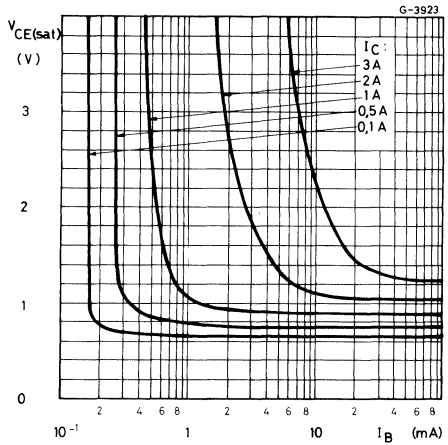

Base-emitter saturation voltage

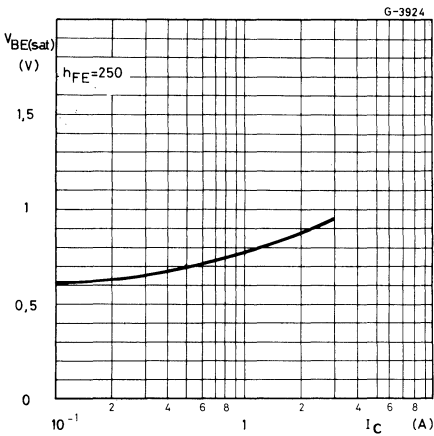

Saturated switching characteristics

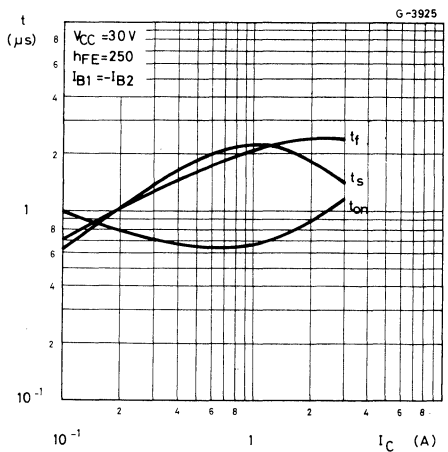

EPITAXIAL-BASE PNP



POWER DARLINGTONS

The BDX 54, BDX 54A, BDX 54B and BDX 54C are silicon epitaxial-base PNP transistors in monolithic Darlington configuration and are mounted in Jedec TO-220 plastic package, intended for use in hammer drivers, audio amplifiers and other medium power linear and switching applications.

The complementary NPN types are the BDX 53, BDX 53A, BDX 53B and BDX 53C respectively.

ABSOLUTE MAXIMUM RATINGS

		BDX54	BDX54A	BDX54B	BDX54C
V_{CBO}	Collector-base voltage ($I_E = 0$)	-45V	-60V	-80V	-100V
V_{CEO}	Collector-emitter voltage ($I_B = 0$)	-45V	-60V	-80V	-100V
V_{EBO}	Emitter-base voltage ($I_C = 0$)			-5V	
I_C	Collector current			-8A	
I_{CM}	Collector peak current (repetitive)			-12A	
I_B	Base current			-0.2A	
P_{tot}	Total power dissipation at $T_{case} \leq 25^\circ C$			60W	
T_{stg}	Storage temperature			-65 to 150°C	
T_j	Junction temperature			150 °C	

INTERNAL SCHEMATIC DIAGRAM

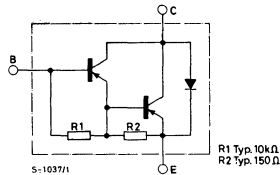

MECHANICAL DATA

Dimensions in mm

Collector connected to tab.

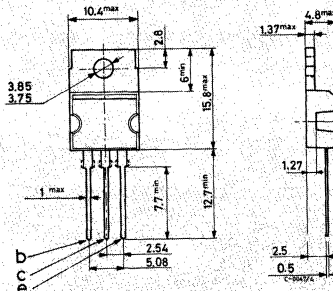

TO-220



THERMAL DATA

$R_{th\ j-case}$	Thermal resistance junction-case	max	2.08	°C/W
$R_{th\ j-amb}$	Thermal resistance junction-ambient	max	70	°C/W

ELECTRICAL CHARACTERISTICS ($T_{case} = 25^{\circ}C$ unless otherwise specified)

Parameter	Test conditions	Min.	Typ.	Max.	Unit
I_{CBO}	Collector cutoff current ($I_E = 0$)	for BDX54 for BDX54A for BDX54B for BDX54C	$V_{CB} = -45V$ $V_{CB} = -60V$ $V_{CB} = -80V$ $V_{CB} = -100V$	-200 -200 -200 -200	μA μA μA μA
I_{CEO}	Collector cutoff current ($I_B = 0$)	for BDX54 for BDX54A for BDX54B for BDX54C	$V_{CE} = -22V$ $V_{CE} = -30V$ $V_{CE} = -40V$ $V_{CE} = -50V$	-500 -500 -500 -500	μA μA μA μA
I_{EBO}	Emitter cutoff current ($I_C = 0$)	$V_{EB} = -5 V$		-2	mA
$V_{CEO(sus)}^*$	Collector-emitter sustaining voltage ($I_B = 0$)	$I_C = -100 mA$		-45 -60 -80 -100	V V V V
$V_{CE(sat)}^*$	Collector-emitter saturation voltage	$I_C = -3A$	$I_B = -12mA$	-2	V
$V_{BE(sat)}^*$	Base-emitter saturation voltage	$I_C = -3A$	$V_{CE} = -12mA$	-2.5	V
h_{FE}^*	DC current gain	$I_C = -3A$	$V_{CE} = -3V$	750	—
V_F	Parallel-diode forward voltage	$I_F = 3A$ $I_F = 8A$		1.8 2.5 2.5	V V

* Pulsed: pulse duration = 300 μs , duty cycle = 1.5%

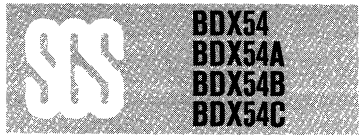

Safe operating areas

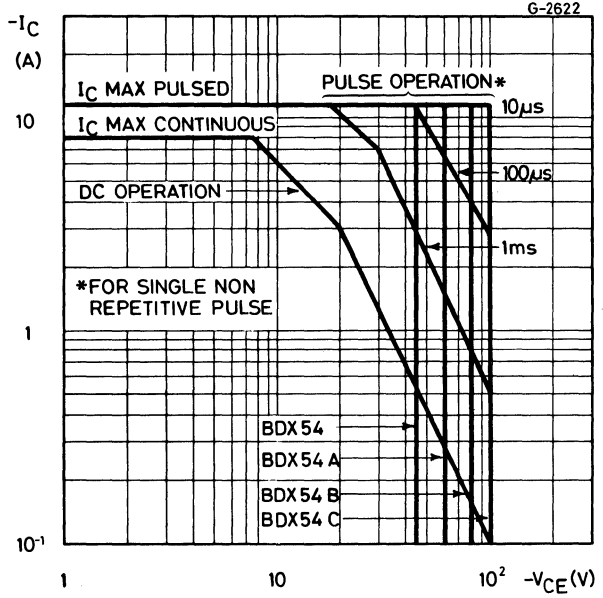

DC current gain

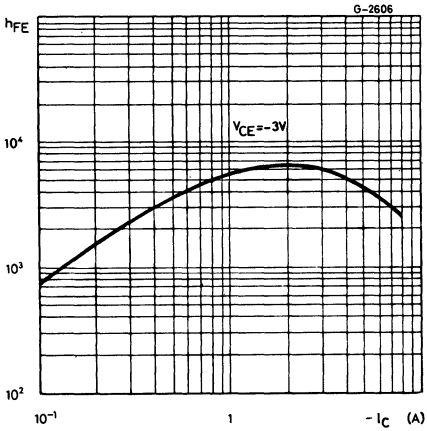

DC transconductance

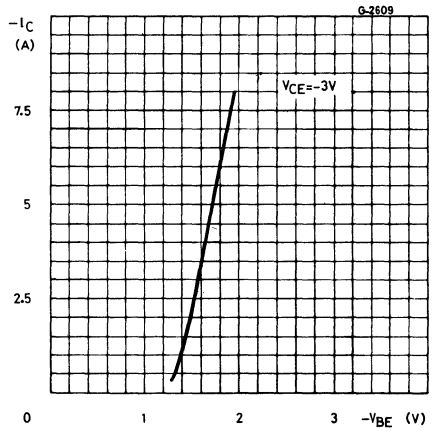



Collector-emitter saturation voltage

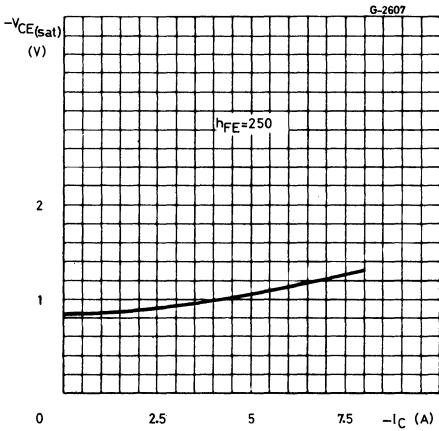

Collector-emitter saturation voltage

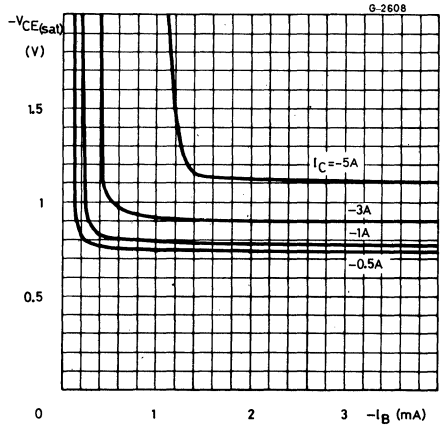

Small signal current gain

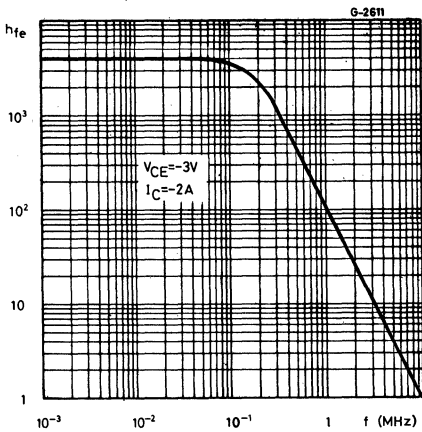

Saturated switching characteristics

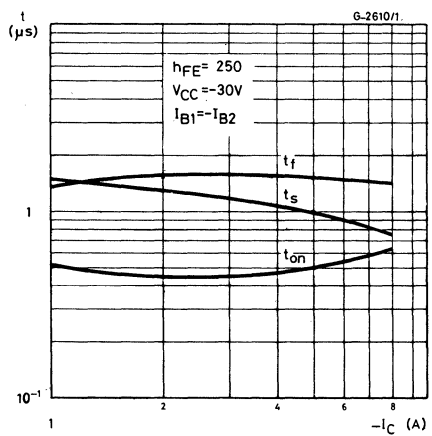

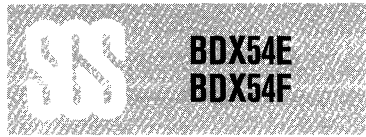

EPITAXIAL-BASE PNP

POWER DARLINGTONS

The BDX 54E, BDX 54F are silicon epitaxial base PNP transistors in monolithic Darlingtion configuration and are mounted in Jedec TO-220 plastic package. They are intended for use in power linear and switching applications. The complementary NPN types are the BDX 53E and BDX 53F respectively.

ABSOLUTE MAXIMUM RATINGS

		BDX54E	BDX54F
V_{CBO}	Collector-base voltage ($I_E=0$)	-140V	-160V
V_{CEO}	Collector-emitter voltage ($I_B=0$)	-140V	-160V
V_{EBO}	Emitter-base voltage ($I_C=0$)		-5V
I_C	Collector current		-8A
I_{CM}	Collector peak current		-12A
I_B	Base current		-0.2A
P_{tot}	Total power dissipation at $T_{case} \leq 25^\circ C$		60W
T_{stg}	Storage temperature		-65 to 150°C
T_j	Junction temperature		150°C

INTERNAL SCHEMATIC DIAGRAM

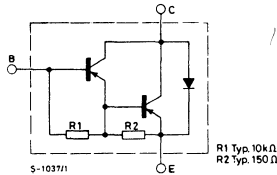

MECHANICAL DATA

Dimensions in mm

Collector connected to tab.

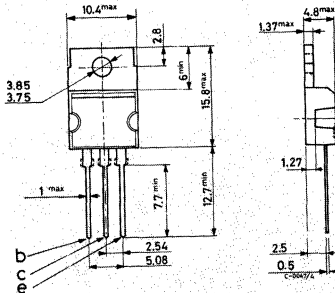

TO-220



BDX54E
BDX54F

THERMAL DATA

$R_{th\ j-case}$	Thermal resistance junction-case	max	2.08 °C/W
$R_{th\ j-amb}$	Thermal resistance junction-ambient	max	70 °C/W

ELECTRICAL CHARACTERISTICS ($T_{case} = 25^{\circ}C$ unless otherwise specified)

Parameter	Test conditions	Min. Typ. Max.	Unit
I_{CEO}	Collector cutoff current ($I_B = 0$)	for BDX54E $V_{CE} = -70V$ for BDX54F $V_{CE} = -80V$	-0.5 -0.5 mA mA
I_{CBO}	Collector cutoff current ($I_E = 0$)	for BDX54E $V_{CB} = -140V$ for BDX54F $V_{CB} = -160V$	-0.2 -0.2 mA mA
I_{EBO}	Emitter cutoff current ($I_E = 0$)	$V_{EB} = -5V$	-5 mA
$V_{CEO(sus)}$	*Collector-emitter sustaining voltage ($I_B = 0$)	$I_C = -50\text{ mA}$ for BDX54E for BDX54F	-140 -160 V V
$V_{CE(sat)}$	*Collector-emitter saturation voltage	$I_C = -2A$ $I_B = -10\text{mA}$	-2 V
$V_{BE(sat)}$	*Base-emitter saturation voltage	$I_C = -2A$ $I_B = -10\text{mA}$	-2.5 V
h_{FE}	DC current gain	$I_C = -2A$ $V_{CE} = -5V$ $I_C = -3A$ $V_{CE} = -5V$	500 150 — —
V_F	Parallel diode forward voltage	$I_F = 2A$	-2.5 V
h_{fe}	Small signal current gain	$I_C = -0.5A$ $V_{CE} = -2V$ $f = 1\text{MHz}$	20 —

* Pulsed: pulse duration = 300 μs , duty cycle = 1%



BDX54E
BDX54F

Safe operating areas

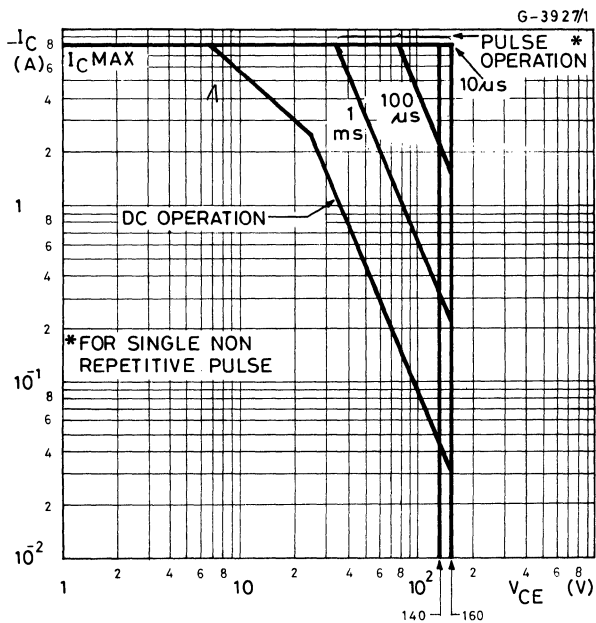

DC current gain

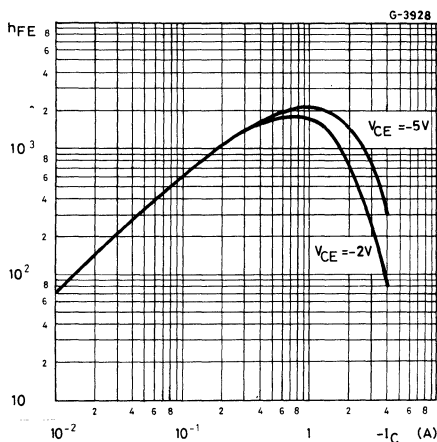

DC transconductance

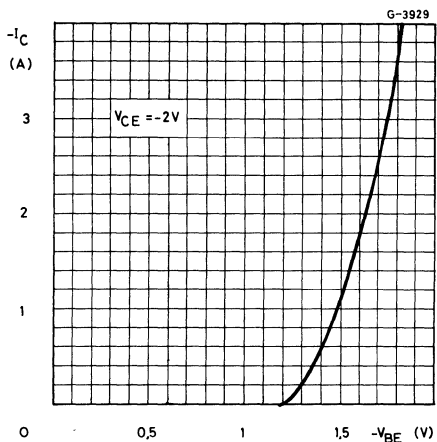



BDX54E
BDX54F

Collector-emitter saturation voltage

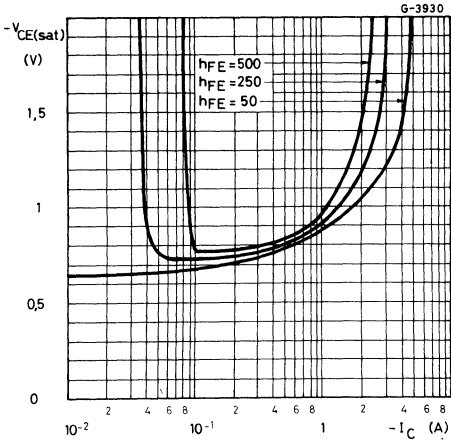

Collector-emitter saturation voltage

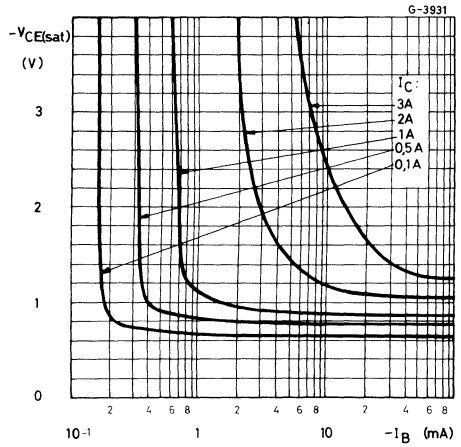

Base-emitter saturation voltage

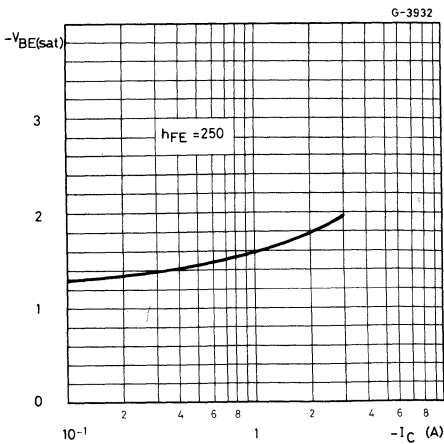

Saturated switching characteristics

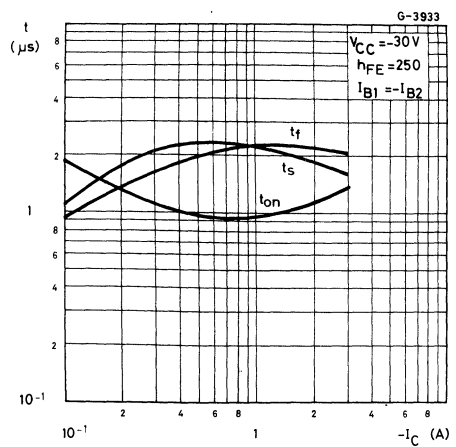



EPITAXIAL-BASE PNP

MEDIUM POWER DARLINGTON

The BDX 54S is a silicon epitaxial-base PNP transistor in monolithic Darlington configuration and is mounted in Jedec TO-39 metal case. It is intended for use in medium power linear and switching applications. The complementary NPN type is the BDX 53S.

ABSOLUTE MAXIMUM RATINGS

V_{CB0}	Collector-base voltage ($I_E = 0$)	-150	V
V_{CEO}	Collector-emitter voltage ($I_B = 0$)	-150	V
V_{EBO}	Emitter-base voltage ($I_C = 0$)	-5	V
I_C	Collector current	-6	A
I_{CM}	Collector peak current	-10	A
I_B	Base current	-0.2	A
P_{tot}	Total power dissipation at $T_{case} \leq 25^\circ C$ $T_{amb} \leq 25^\circ C$	15	W
		1	W
T_{stg}	Storage temperature	-65 to 200	$^\circ C$
T_j	Junction temperature	200	$^\circ C$

INTERNAL SCHEMATIC DIAGRAM

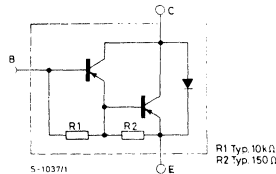

MECHANICAL DATA

Dimensions in mm

Collector connected to case

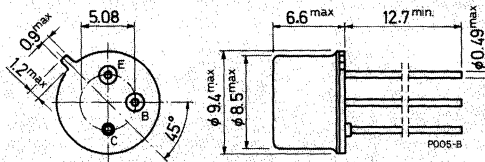

TO-39

**BDX54S****THERMAL DATA**

$R_{th\ j-case}$	Thermal resistance junction-case	max	11.66	°C/W
$R_{th\ j-amb}$	Thermal resistance junction-ambient	max	175	°C/W

ELECTRICAL CHARACTERISTICS ($T_{case} = 25^{\circ}C$ unless otherwise specified)

Parameter	Test conditions	Min.	Typ.	Max.	Unit
I_{CBO} Collector cutoff current ($I_E = 0$)	$V_{CB} = -150V$ $T_{case} = 125^{\circ}C$ $V_{CB} = -150V$			-0.2	mA
				-2	mA
I_{CEO} Collector cutoff current ($I_B = 0$)	$V_{CE} = -75V$			-0.2	mA
I_{EBO} Emitter cutoff current ($I_C = 0$)	$V_{EB} = -5V$			-5	mA
$V_{CEO(sus)}$ *Collector-emitter sustaining voltage ($I_B = 0$)	$I_C = -50\text{ mA}$	-150			V
$V_{CE(sat)}$ * Collector-emitter saturation voltage	$I_C = -2A$ $I_B = -8mA$			-2	V
$V_{BE(sat)}$ * Base-emitter saturation voltage	$I_C = -2A$ $I_B = -8mA$			-2.5	V
h_{FE} * DC current gain	$I_C = -100mA$ $V_{CE} = -5V$ $I_C = -2A$ $V_{CE} = -5V$		100		—
			500		—
V_F * Parallel diode forward voltage	$I_F = -2A$			-2.5	V
h_{fe} Small signal current gain	$I_C = -0.5A$ $V_{CE} = -2V$ $f = 1MHz$		20		—

* Pulsed: pulse duration = 300 μs , duty cycle = 1%



Safe operating area

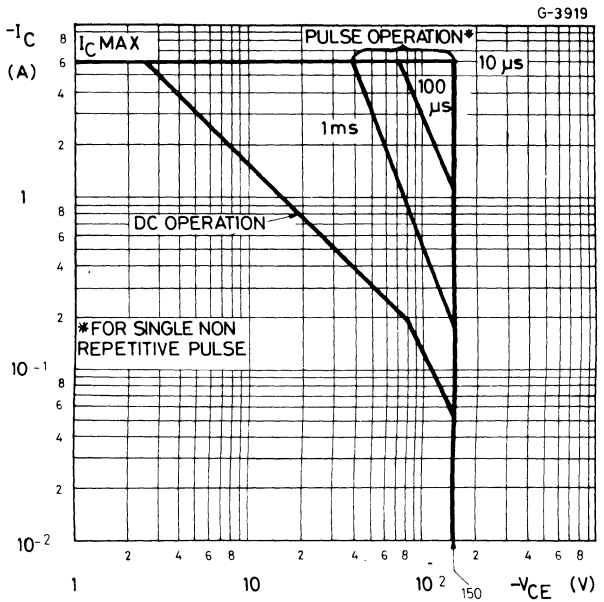

DC current gain

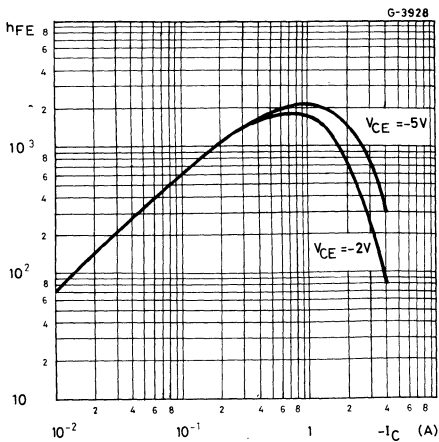

DC transconductance

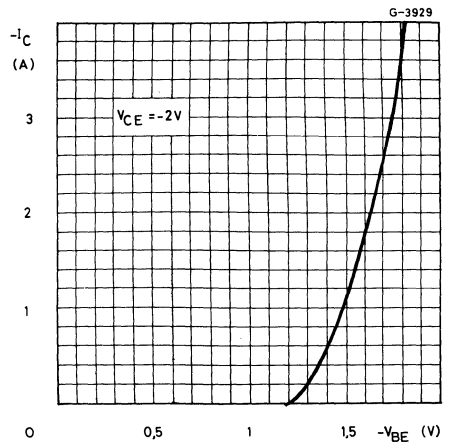



Collector-emitter saturation voltage

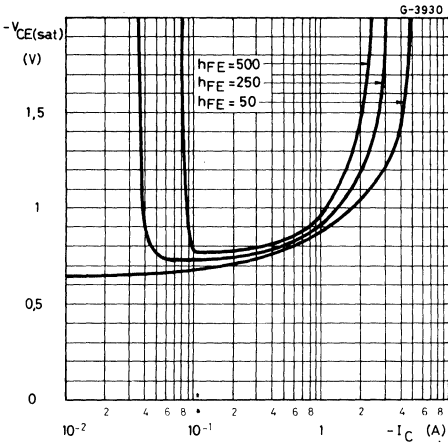

Collector-emitter saturation voltage

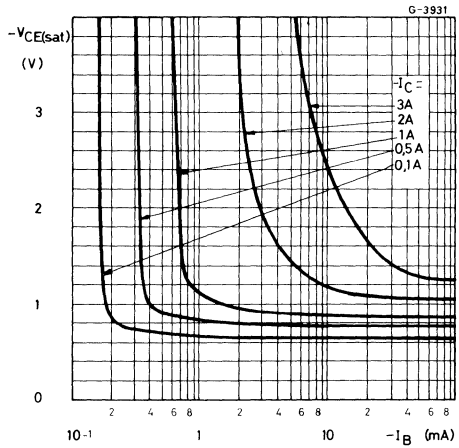

Base-emitter saturation voltage

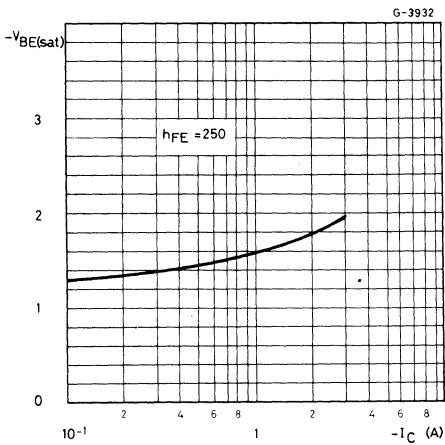

Saturated switching characteristics

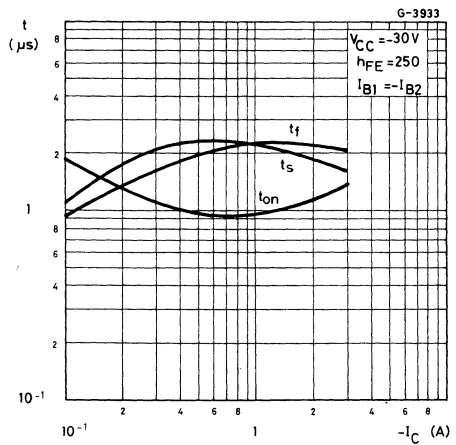

EPITAXIAL-BASE NPN



POWER DARLINGTONS

The BDX 85, BDX 85A, BDX 85B and BDX 85C are silicon epitaxial-base NPN power transistors in monolithic Darlington configuration and are mounted in Jedec TO-3 metal case. They are intended for use in power linear and switching applications. The complementary PNP types are the BDX 86, BDX 86A, BDX 86B and BDX 86C respectively.

ABSOLUTE MAXIMUM RATINGS

		BDX85	BDX85A	BDX85B	BDX85C
V_{CBO}	Collector-base voltage ($I_E = 0$)	45V	60V	80V	100V
V_{CEO}	Collector-emitter voltage ($I_B = 0$)	45V	60V	80V	100V
V_{EBO}	Emitter-base voltage ($I_C = 0$)			5V	
I_C	Collector current			10A	
I_{CM}	Collector peak current (repetitive)			15A	
I_B	Base current			0.1A	
P_{tot}	Total power dissipation at $T_{case} \leq 25^\circ C$			100W	
T_{stg}	Storage temperature			-65 to 200°C	
T_j	Junction temperature			200 °C	

INTERNAL SCHEMATIC DIAGRAM

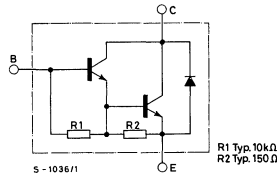

MECHANICAL DATA

Dimensions in mm

Collector connected to case

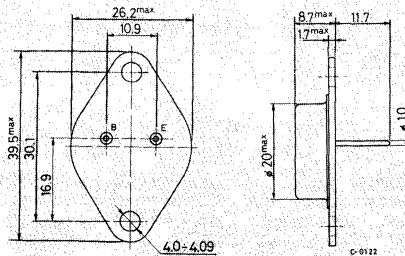

TO-3

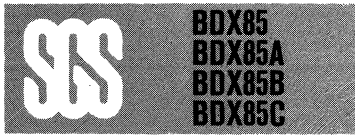

THERMAL DATA

$R_{th\ j-case}$	Thermal resistance junction-case	max	1.75	$^{\circ}C/W$
------------------	----------------------------------	-----	------	---------------

ELECTRICAL CHARACTERISTICS ($T_{case} = 25^{\circ}C$ unless otherwise specified)

Parameter	Test conditions	Min.	Typ.	Max.	Unit	
I_{CBO} Collector cutoff current ($I_E = 0$)	for BDX85 $V_{CB} = 45\ V$		500		μA	
	for BDX85A $V_{CB} = 60\ V$		500		μA	
	for BDX85B $V_{CB} = 80\ V$		500		μA	
	for BDX85C $V_{CB} = 100\ V$		500		μA	
	$T_{case} = 150^{\circ}C$					
	for BDX85 $V_{CB} = 45\ V$			5		mA
for BDX85A $V_{CB} = 60\ V$			5		mA	
for BDX85B $V_{CB} = 80\ V$			5		mA	
for BDX85C $V_{CB} = 100\ V$			5		mA	
I_{CEO} Collector cutoff current ($I_B = 0$)	for BDX85 $V_{CE} = 22\ V$		1		mA	
	for BDX85A $V_{CE} = 30\ V$		1		mA	
	for BDX85B $V_{CE} = 40\ V$		1		mA	
	for BDX85C $V_{CE} = 50\ V$		1		mA	
I_{EBO} Emitter cutoff current ($I_C = 0$)	$V_{EB} = 5\ V$		2		mA	
$V_{CEO(sus)}^*$ Collector-emitter sustaining voltage ($I_B = 0$)	$I_C = 100\ mA$ for BDX85 for BDX85A for BDX85B for BDX85C	45			V	
		60			V	
		80			V	
		100			V	
$V_{CE(sat)}^*$ Collector-emitter saturation voltage	$I_C = 4\ A$ $I_B = 16\ mA$		2		V	
	$I_C = 8\ A$ $I_B = 40\ mA$		4		V	
$V_{BE(sat)}^*$ Base-emitter saturation voltage	$I_C = 8\ A$ $I_B = 80\ mA$		4		V	
V_{BE}^* Base-emitter voltage	$I_C = 4\ A$ $V_{CE} = 3\ V$		2.8		V	
h_{FE}^* DC current gain	$I_C = 3\ A$ $V_{CE} = 3\ V$	1000			—	
	$I_C = 4\ A$ $V_{CE} = 3\ V$	750	18000		—	
	$I_C = 8\ A$ $V_{CE} = 4\ V$	200			—	
V_F Parallel-diode forward voltage	$I_F = 3\ A$		2.5	1.8	V	
	$I_F = 8\ A$				V	
h_{fe} Small signal current gain	$I_C = 3\ A$ $V_{CE} = 3\ V$ $f = 1\ MHz$		10		—	

* Pulsed: pulse duration = 300 μs , duty cycle = 1.5%

Safe operating areas
(for **BDX85** and **BDX85A**)

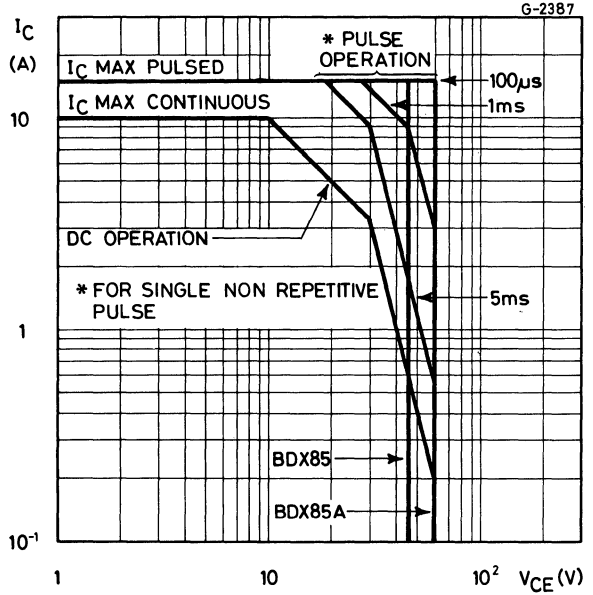

Safe operating areas
(for **BDX85B** and **BDX85C**)

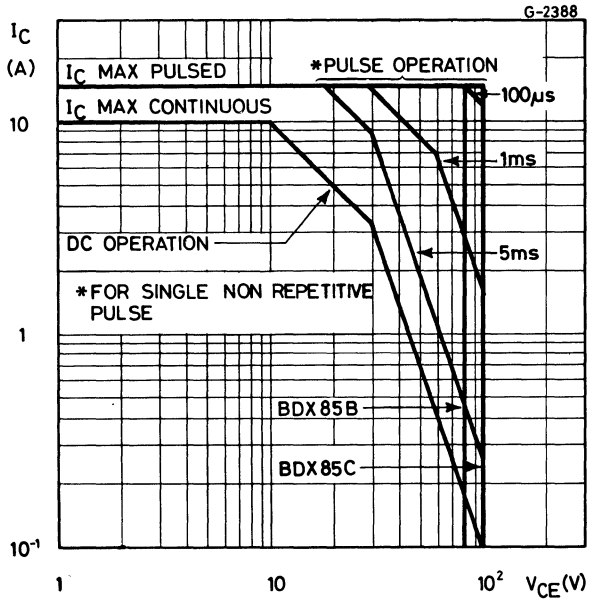

DC current gain

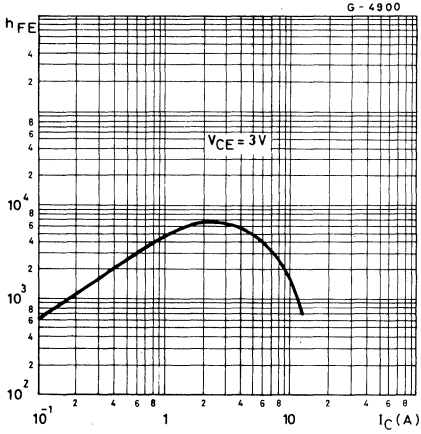

DC transconductance

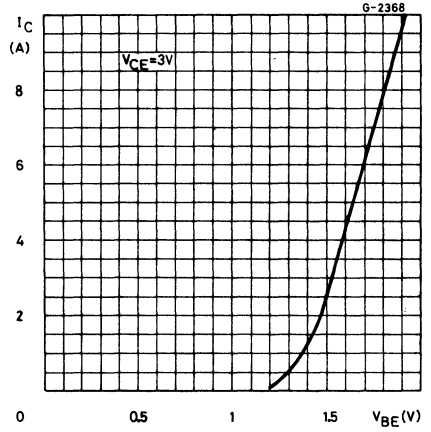

Collector-emitter saturation voltage

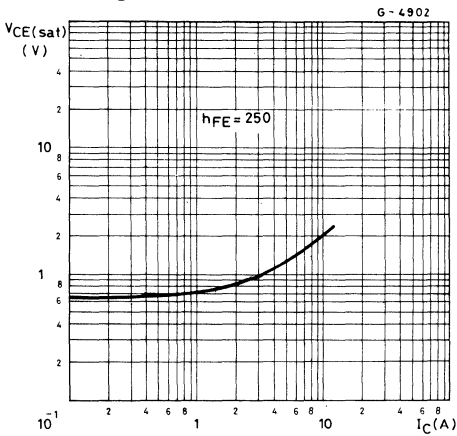

Collector-emitter saturation voltage

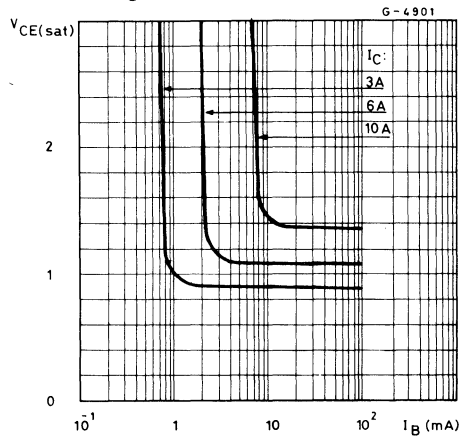

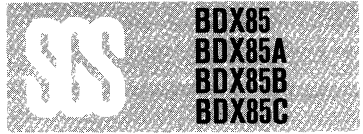

Small signal current gain

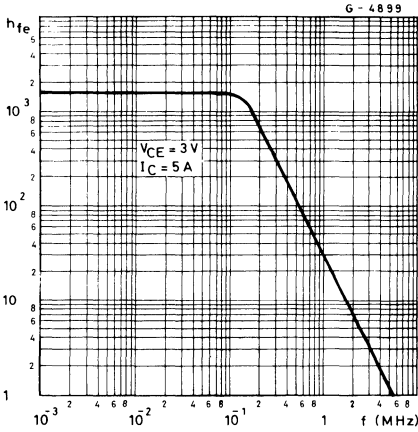

Collector-base capacitance

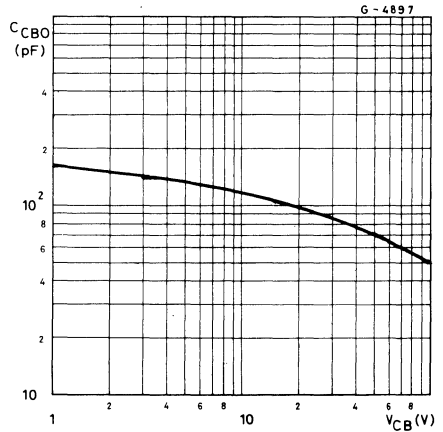

Saturated switching characteristics

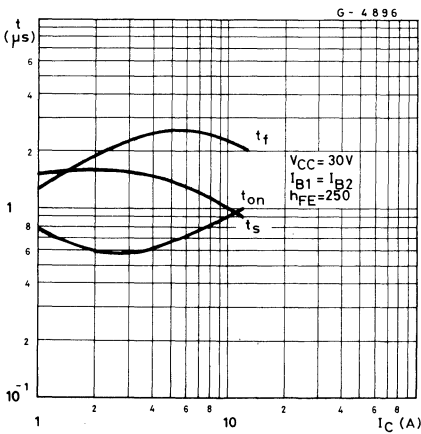

Power rating chart

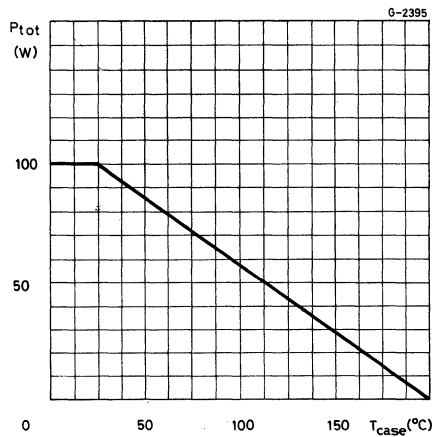



EPITAXIAL-BASE PNP

POWER DARLINGTONS

The BDX 86, BDX 86A, BDX 86B and BDX 86C are silicon epitaxial-base PNP power transistors in monolithic Darlington configuration and are mounted in Jedec TO-3 metal case. They are intended for use in power linear and switching applications. The complementary NPN types are the BDX 85, BDX 85A, BDX 85B and BDX 85C respectively.

ABSOLUTE MAXIMUM RATINGS

		BDX86	BDX86A	BDX86B	BDX86C
V_{CB0}	Collector-base voltage ($I_E = 0$)	-45V	-60V	-80V	-100V
V_{CEO}	Collector-emitter voltage ($I_B = 0$)	-45V	-60V	-80V	-100V
V_{EBO}	Emitter-base voltage ($I_C = 0$)			-5V	
I_C	Collector current			-10A	
I_{CM}	Collector peak current (repetitive)			-15A	
I_B	Base current			-0.1A	
P_{tot}	Total power dissipation at $T_{case} \leq 25^\circ C$			100W	
T_{stg}	Storage temperature			-65 to 200°C	
T_j	Junction temperature			200 °C	

INTERNAL SCHEMATIC DIAGRAM

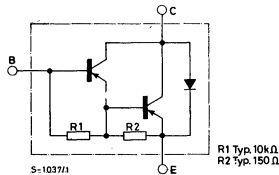

MECHANICAL DATA

Dimensions in mm

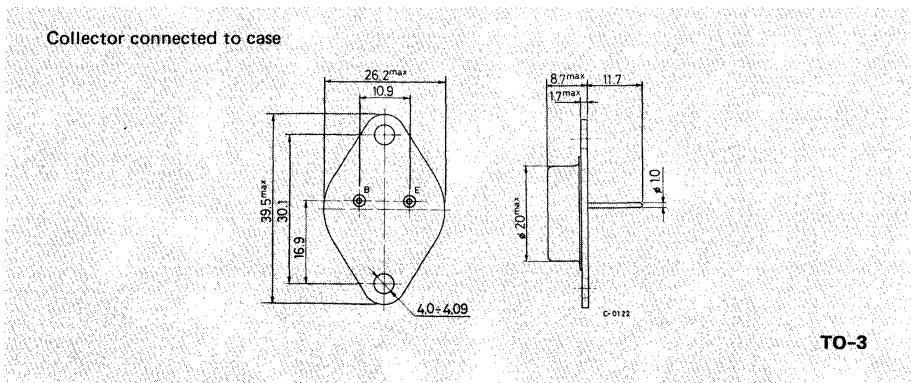

TO-3

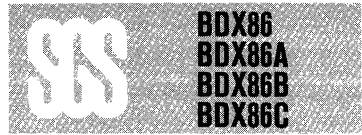

THERMAL DATA

$R_{th\ j-case}$	Thermal resistance junction-case	max 1.75 °C/W
------------------	----------------------------------	---------------

ELECTRICAL CHARACTERISTICS ($T_{case} = 25^{\circ}C$ unless otherwise specified)

Parameter	Test conditions	Min. Typ. Max.	Unit	
I_{CBO}	Collector cutoff current ($I_E = 0$)	for BDX86 $V_{CB} = -45\ V$ for BDX86A $V_{CB} = -60\ V$ for BDX86B $V_{CB} = -80\ V$ for BDX86C $V_{CB} = -100\ V$ $T_{case} = 150^{\circ}C$ for BDX86 $V_{CB} = -45\ V$ for BDX86A $V_{CB} = -60\ V$ for BDX86B $V_{CB} = -80\ V$ for BDX86C $V_{CB} = -100\ V$	-500 -500 -500 -500 -5 -5 -5 -5	μA μA μA μA mA mA mA mA
I_{CEO}	Collector cutoff current ($I_B = 0$)	for BDX86 $V_{CE} = -22\ V$ for BDX86A $V_{CE} = -30\ V$ for BDX86B $V_{CE} = -40\ V$ for BDX86C $V_{CE} = -50\ V$	-1 -1 -1 -1	mA mA mA mA
I_{EBO}	Emitter cutoff current ($I_C = 0$)	$V_{EB} = -5\ V$	-2	mA
$V_{CEO(sus)}^*$	Collector-emitter sustaining voltage ($I_B = 0$)	$I_C = -100\ mA$ for BDX86 for BDX86A for BDX86B for BDX86C	-45 -60 -80 -100	V V V V
$V_{CE(sat)}^*$	Collector-emitter saturation voltage	$I_C = -4A$ $I_B = -16\ mA$ $I_C = -8A$ $I_B = -40\ mA$	-2 -4	V V
$V_{BE(sat)}^*$	Base-emitter saturation voltage	$I_C = -8A$ $I_B = -80\ mA$	-4	V
V_{BE}^*	Base-emitter voltage	$I_C = -4A$ $V_{CE} = -3V$	-2.8	V
h_{FE}^*	DC current gain	$I_C = -3A$ $V_{CE} = -3V$ $I_C = -4A$ $V_{CE} = -3V$ $I_C = -8A$ $V_{CE} = -4V$	1000 750 18000 200	— — —
V_F	Parallel-diode forward voltage	$I_F = 3A$ $I_F = 8A$	2.5 1.8	V V
h_{fe}	Small signal current gain	$I_C = -3A$ $V_{CE} = -3V$ $f = 1\ MHz$	10	—

* Pulsed: pulse duration = 300 μs , duty cycle = 1.5%

Safe operating areas
(for **BDX86** and **BDX86A**)

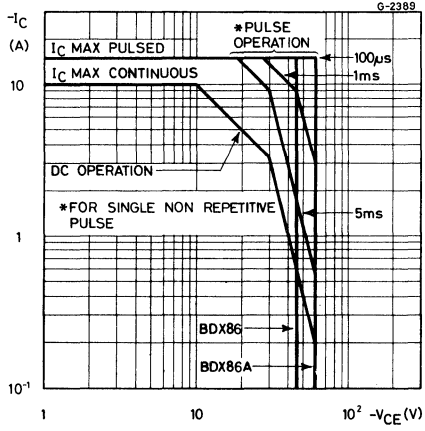

Safe operating areas
(for **BDX86B** and **BDX86C**)

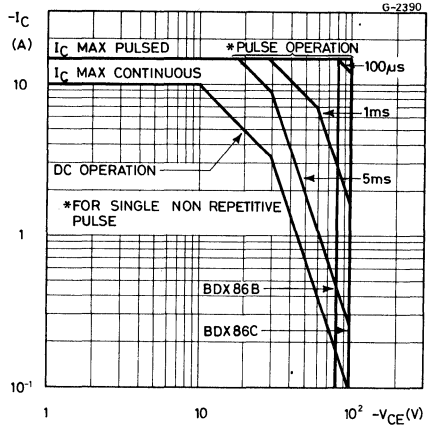

DC current gain

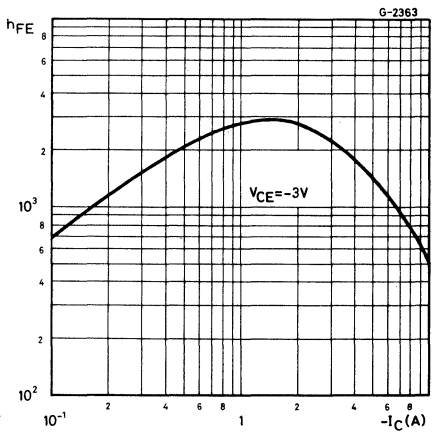

DC transconductance

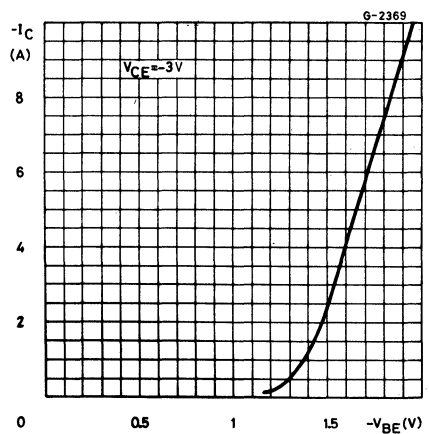

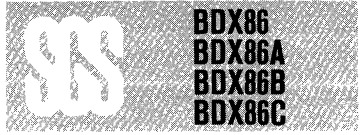

Collector-emitter saturation voltage

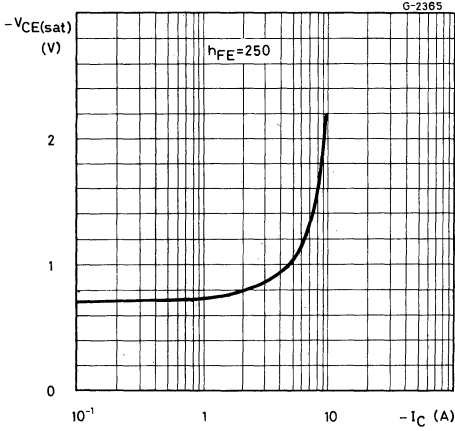

Collector-emitter saturation voltage

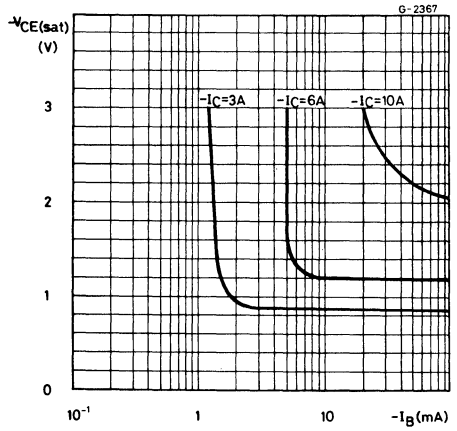

Base-emitter saturation voltage

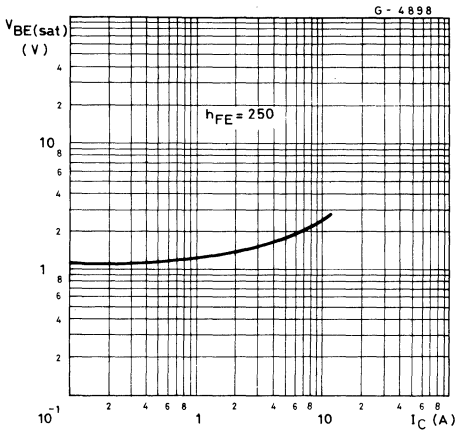

Small signal current gain

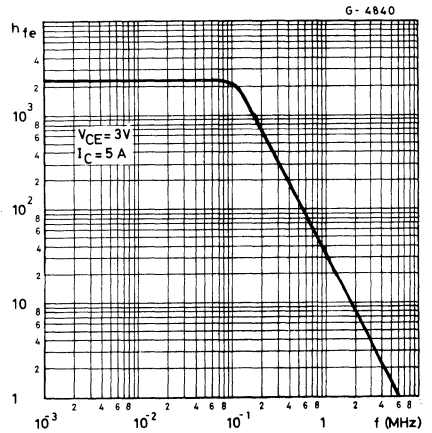

Collector-base capacitance

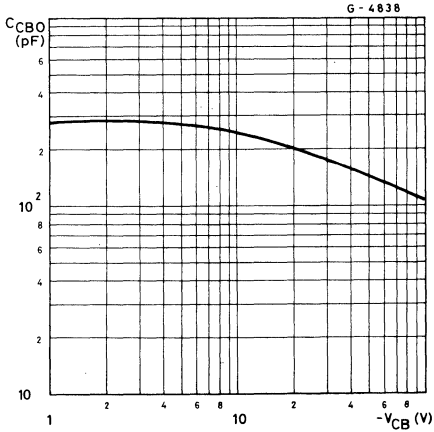

Saturated switching characteristics

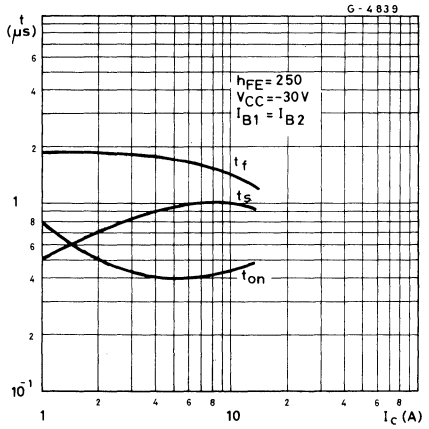

Power rating chart

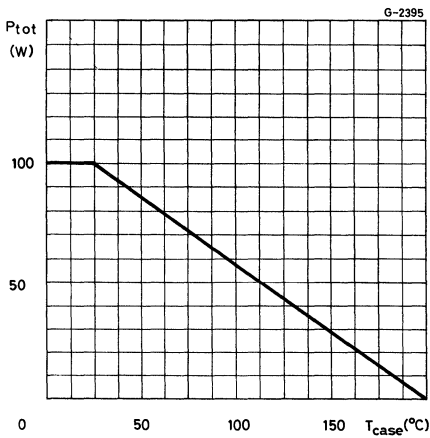

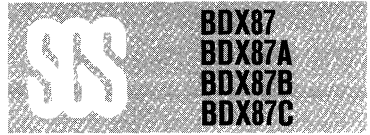

EPITAXIAL-BASE NPN

POWER DARLINGTONS

The BDX 87, BDX 87A, BDX 87B and BDX 87C are silicon epitaxial-base NPN power transistors in monolithic Darlington configuration and are mounted in Jedec TO-3 metal case. They are intended for use in power linear and switching applications. The complementary PNP types are the BDX 88, BDX 88A, BDX 88B and BDX 88C respectively.

ABSOLUTE MAXIMUM RATINGS

		BDX87	BDX87A	BDX87B	BDX87C
V_{CBO}	Collector-base voltage ($I_E = 0$)	45V	60V	80V	100V
V_{CEO}	Collector-emitter voltage ($I_B = 0$)	45V	60V	80V	100V
V_{EBO}	Emitter-base voltage ($I_C = 0$)			5V	
I_C	Collector current			12A	
I_{CM}	Collector peak current (repetitive)			18A	
I_B	Base current			0.2A	
P_{tot}	Total power dissipation at $T_{case} \leq 25^\circ C$			120W	
T_{stg}	Storage temperature			-65 to 200°C	
T_j	Junction temperature			200 °C	

INTERNAL SCHEMATIC DIAGRAM

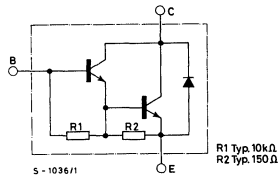

MECHANICAL DATA

Dimensions in mm

Collector connected to case

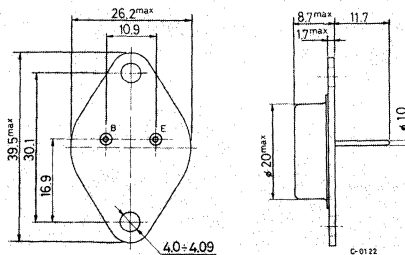

TO-3



BDX87
BDX87A
BDX87B
BDX87C

THERMAL DATA

$R_{th\ j-case}$	Thermal resistance junction-case	max 1.45 °C/W
------------------	----------------------------------	---------------

ELECTRICAL CHARACTERISTICS ($T_{case} = 25^{\circ}C$ unless otherwise specified)

Parameter	Test conditions	Min. Typ. Max.	Unit
I_{CBO} Collector cutoff current ($I_E = 0$)	for BDX87 $V_{CB} = 45\ V$ for BDX87A $V_{CB} = 60\ V$ for BDX87B $V_{CB} = 80\ V$ for BDX87C $V_{CB} = 100\ V$ $T_{case} = 150^{\circ}C$ for BDX87 $V_{CB} = 45\ V$ for BDX87A $V_{CB} = 60\ V$ for BDX87B $V_{CB} = 80\ V$ for BDX87C $V_{CB} = 100\ V$	500 500 500 500 5 5 5 5	μA μA μA μA mA mA mA mA
I_{CEO} Collector cutoff current ($I_B = 0$)	for BDX87 $V_{CE} = 22\ V$ for BDX87A $V_{CE} = 30\ V$ for BDX87B $V_{CE} = 40\ V$ for BDX87C $V_{CE} = 50\ V$	1 1 1 1	mA mA mA mA
I_{EBO} Emitter cutoff current ($I_C = 0$)	$V_{EB} = 5\ V$	2	mA
$V_{CEO(sus)}^*$ Collector-emitter sustaining voltage ($I_B = 0$)	$I_C = 100\ mA$ for BDX87 for BDX87A for BDX87B for BDX87C	45 60 80 100	V V V V
$V_{CE(sat)}^*$ Collector-emitter saturation voltage	$I_C = 6A$ $I_B = 24\ mA$ $I_C = 12A$ $I_B = 120\ mA$	2 3	V V
$V_{BE(sat)}^*$ Base-emitter saturation voltage	$I_C = 12A$ $I_B = 120\ mA$	4	V
V_{BE}^* Base-emitter voltage	$I_C = 6A$ $V_{CE} = 3V$	2.8	V
h_{FE}^* DC current gain	$I_C = 5A$ $V_{CE} = 3V$ $I_C = 6A$ $V_{CE} = 3V$ $I_C = 12A$ $V_{CE} = 3V$	1000 750 18000 100	— — —
V_F Parallel-diode forward voltage	$I_F = 3A$ $I_F = 8A$	2.5 1.8	V V
h_{fe} Small signal current gain	$I_C = 5A$ $V_{CE} = 3V$ $f = 1\ MHz$	25	—

* Pulsed: pulse duration = 300 μs , duty cycle = 1.5%

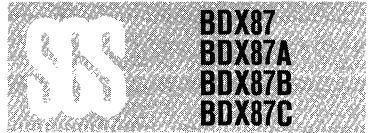

Safe operating areas
(for **BDX87** and **BDX87A**)

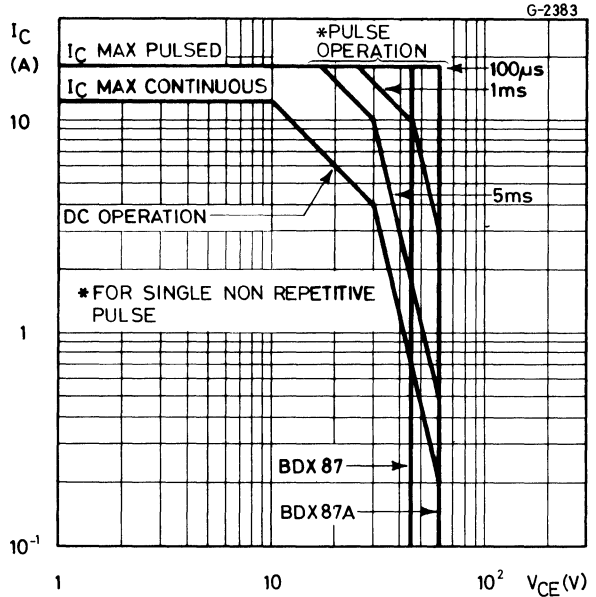

Safe operating areas
(for **BDX87B** and **BDX87C**)

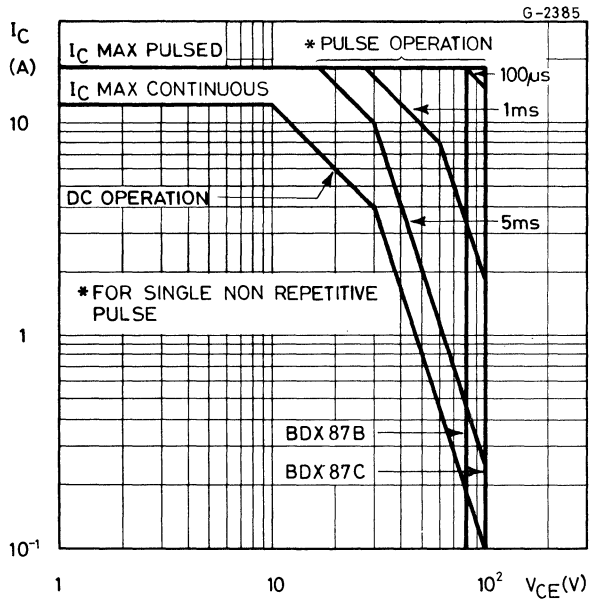



DC current gain

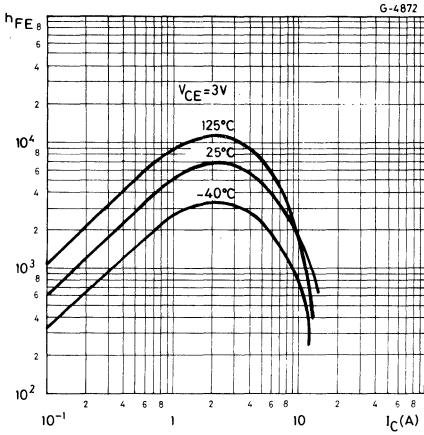

DC transconductance

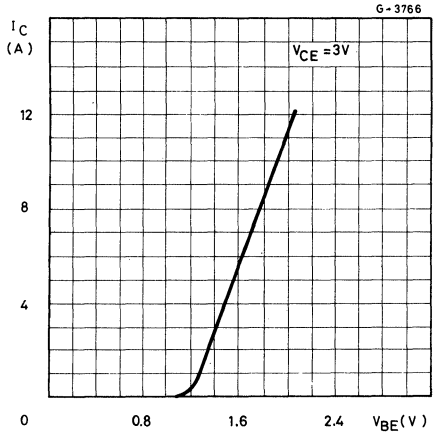

Collector-emitter saturation voltage

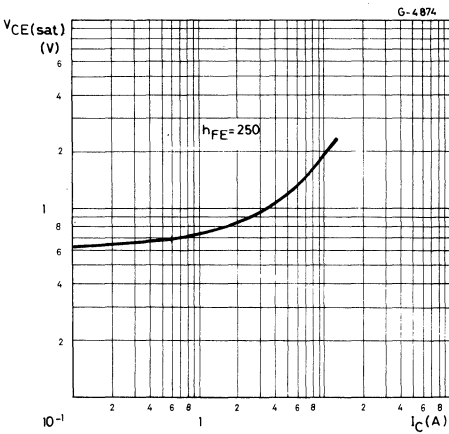

Collector-emitter saturation voltage

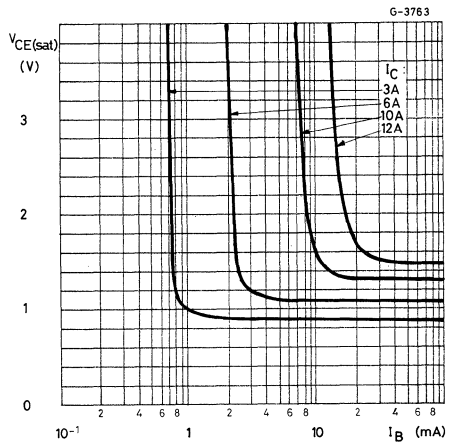

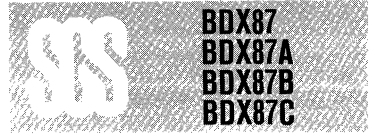

Base-emitter saturation voltage

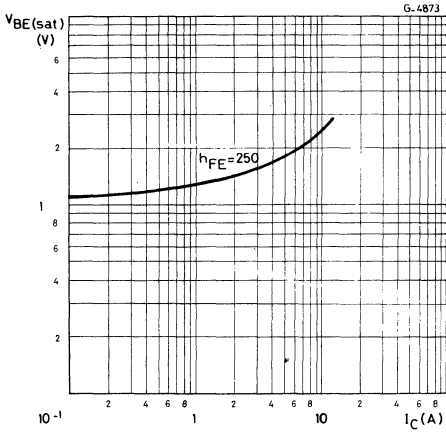

Small signal current gain

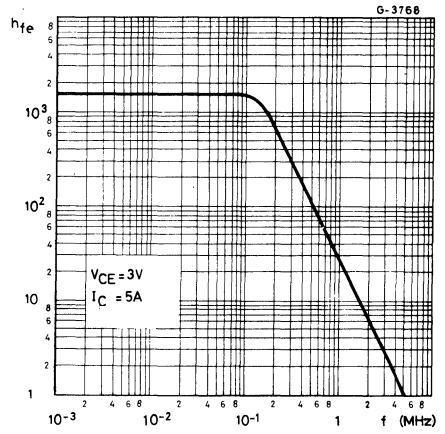

Collector-base capacitance

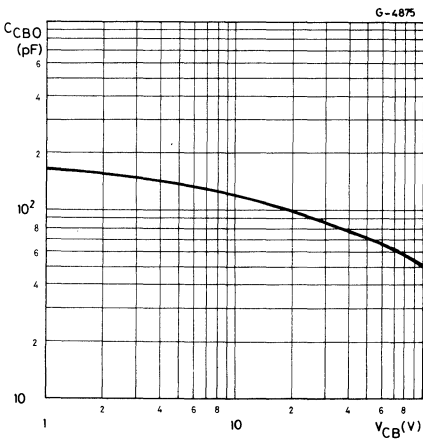

Saturated switching characteristics

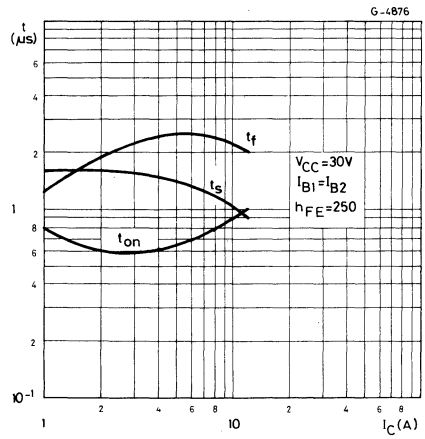

POWER DARLINGTONS

The BDX 88, BDX 88A, BDX 88B and BDX 88C are silicon epitaxial-base PNP power transistors in monolithic Darlington configuration and are mounted in Jedec TO-3 metal case. They are intended for use in power linear and switching applications. The complementary NPN types are the BDX 87, BDX 87A, BDX 87B and BDX 87C respectively.

ABSOLUTE MAXIMUM RATINGS

		BDX88	BDX88A	BDX88B	BDX88C
V_{CBO}	Collector-base voltage ($I_E = 0$)	-45V	-60V	-80V	-100V
V_{CEO}	Collector-emitter voltage ($I_B = 0$)	-45V	-60V	-80V	-100V
V_{EBO}	Emitter-base voltage ($I_C = 0$)			-5V	
I_C	Collector current			-12A	
I_{CM}	Collector peak current (repetitive)			-18A	
I_B	Base current			-0.2A	
P_{tot}	Total power dissipation at $T_{case} \leq 25^\circ C$			120W	
T_{stg}	Storage temperature			-65 to 200°C	
T_j	Junction temperature			200 °C	

INTERNAL SCHEMATIC DIAGRAM

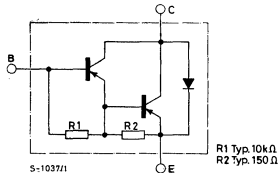

MECHANICAL DATA

Dimensions in mm

Collector connected to case

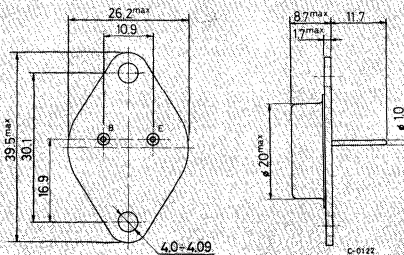

TO-3

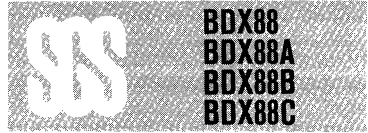

THERMAL DATA

$R_{th\ j\text{-case}}$	Thermal resistance junction-case	max 1.45 °C/W
-------------------------	----------------------------------	---------------

ELECTRICAL CHARACTERISTICS ($T_{case} = 25^{\circ}\text{C}$ unless otherwise specified)

Parameter	Test conditions	Min. Typ. Max.	Unit
I_{CBO} Collector cutoff current ($I_E = 0$)	for BDX88 $V_{CB} = -45\text{ V}$ for BDX88A $V_{CB} = -60\text{ V}$ for BDX88B $V_{CB} = -80\text{ V}$ for BDX88C $V_{CB} = -100\text{ V}$ $T_{case} = 150^{\circ}\text{C}$ for BDX88 $V_{CB} = -45\text{ V}$ for BDX88A $V_{CB} = -60\text{ V}$ for BDX88B $V_{CB} = -80\text{ V}$ for BDX88C $V_{CB} = -100\text{ V}$	-500 -500 -500 -500 -5 -5 -5 -5	μA μA μA μA mA mA mA mA
I_{CEO} Collector cutoff current ($I_B = 0$)	for BDX88 $V_{CE} = -22\text{ V}$ for BDX88A $V_{CE} = -30\text{ V}$ for BDX88B $V_{CE} = -40\text{ V}$ for BDX88C $V_{CE} = -50\text{ V}$	-1 -1 -1 -1	mA mA mA mA
I_{EBO} Emitter cutoff current ($I_C = 0$)	$V_{EB} = -5\text{ V}$	-2	mA
$V_{CEO(sus)}$ * Collector-emitter sustaining voltage ($I_B = 0$)	$I_C = -100\text{ mA}$ for BDX88 for BDX88A for BDX88B for BDX88C	-45 -60 -80 -100	V V V V
$V_{CE(sat)}$ * Collector-emitter saturation voltage	$I_C = -6\text{A}$ $I_B = -24\text{ mA}$ $I_C = -12\text{A}$ $I_B = -120\text{ mA}$	-2 -3	V V
$V_{BE(sat)}$ * Base-emitter saturation voltage	$I_C = -12\text{A}$ $I_B = -120\text{ mA}$	-4	V
V_{BE} * Base-emitter voltage	$I_C = -6\text{A}$ $V_{CE} = -3\text{V}$	-2.8	V
h_{FE} * DC current gain	$I_C = -5\text{A}$ $V_{CE} = -3\text{V}$ $I_C = -6\text{A}$ $V_{CE} = -3\text{V}$ $I_C = -12\text{A}$ $V_{CE} = -3\text{V}$	1000 750 18000 100	— — —
V_F Parallel-diode forward voltage	$I_F = 3\text{A}$ $I_F = 8\text{A}$	1.8 2.5	V V
h_{fe} Small signal current gain	$I_C = -5\text{A}$ $V_{CE} = -3\text{V}$ $f = 1\text{ MHz}$	35	—

* Pulsed: pulse duration = 300 μs , duty cycle = 1.5%

Safe operating areas
(for **BDX88** and **BDX88A**)

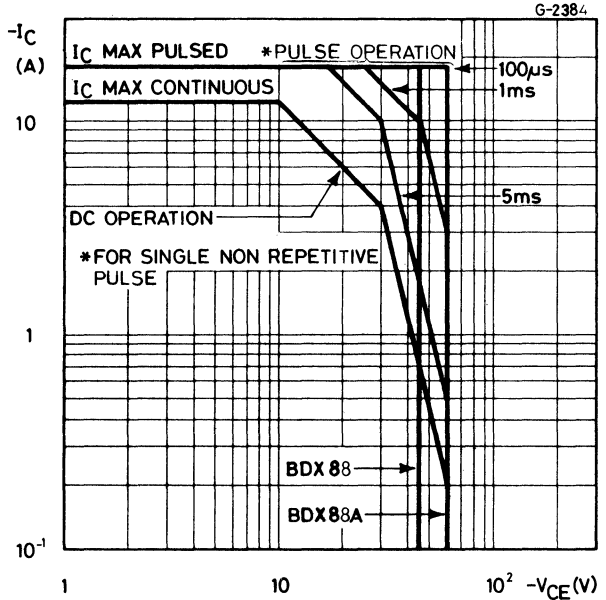

Safe operating areas
(for **BDX88B** and **BDX88C**)

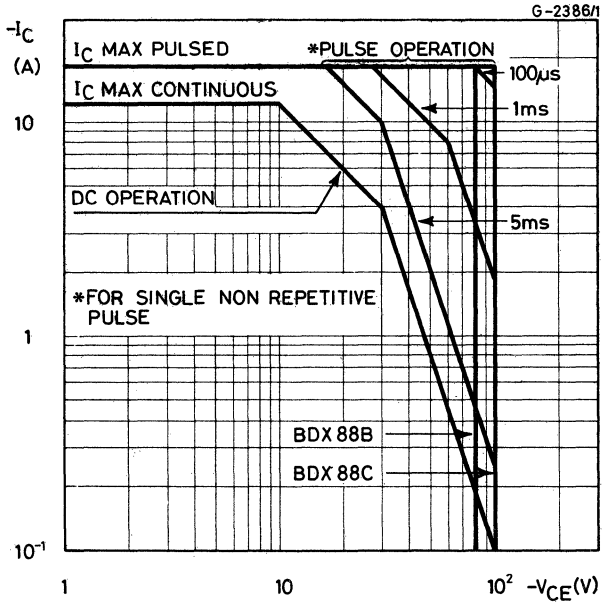

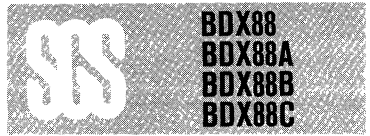

DC current gain

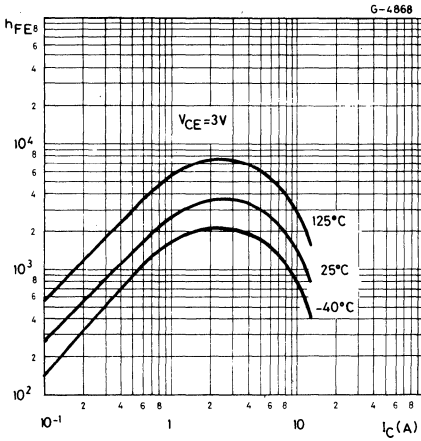

DC transconductance

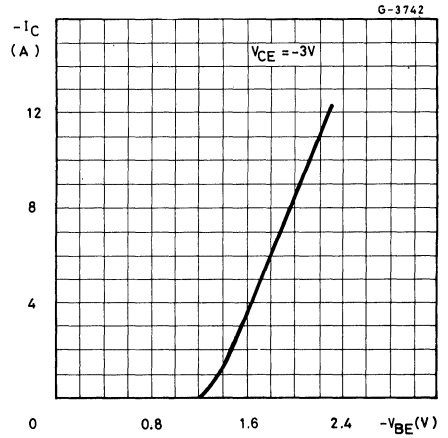

Collector-emitter saturation voltage

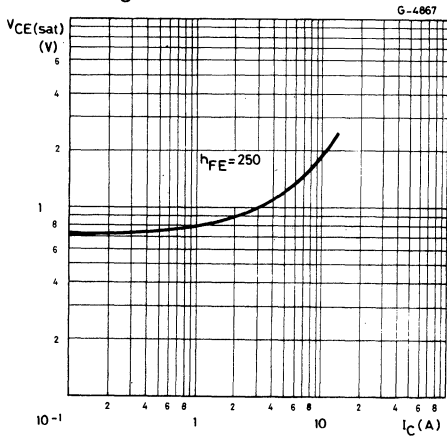

Collector-emitter saturation voltage

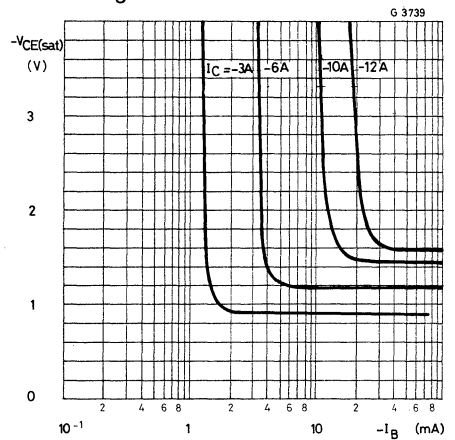

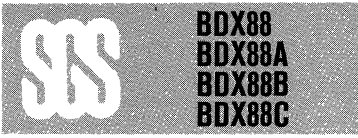

Base-emitter saturation voltage

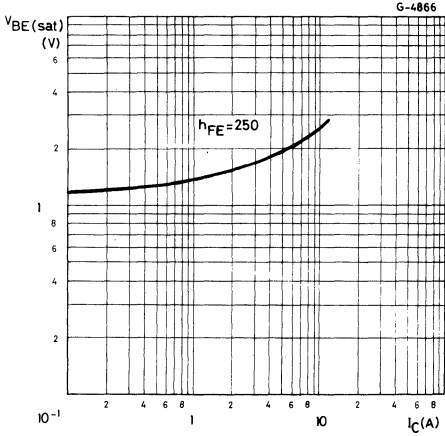

Small signal current gain

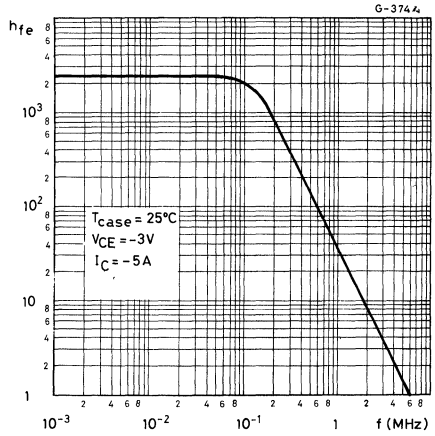

Collector-base capacitance

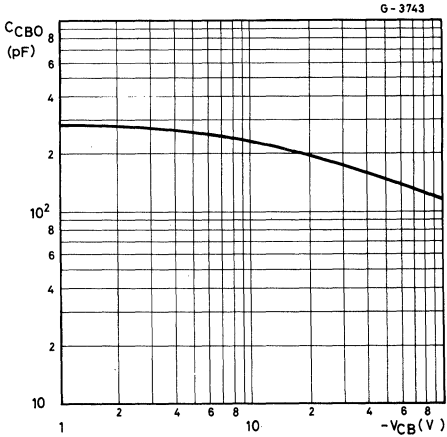

Saturated switching characteristics

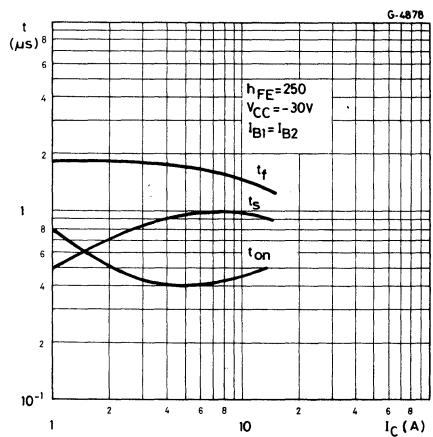

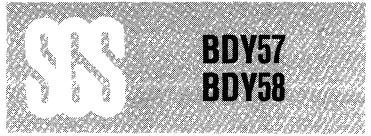

MULTIEPITAXIAL PLANAR NPN

HIGH CURRENT, HIGH SPEED, HIGH POWER TRANSISTORS

The BDY 57 and BDY 58 are silicon multi-epitaxial planar NPN transistors in Jedec TO-3 metal case, intended for use in switching and linear applications in military and industrial equipment.

ABSOLUTE MAXIMUM RATINGS

		BDY 57	BDY 58
V_{CB0}	Collector-base voltage ($I_E = 0$)	120V	160V
V_{CE0}	Collector-emitter voltage ($I_B = 0$)	80V	125V
V_{EBO}	Emitter-base voltage ($I_C = 0$)		10V
I_C	Collector current		25A
I_B	Base current		6A
P_{tot}	Total power dissipation at $T_{case} \leq 25^\circ C$		175W
T_{stg}	Storage temperature		-65 to 200°C
T_j	Junction temperature		200°C

INTERNAL SCHEMATIC DIAGRAM

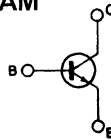

MECHANICAL DATA

Dimensions in mm

Collector connected to case

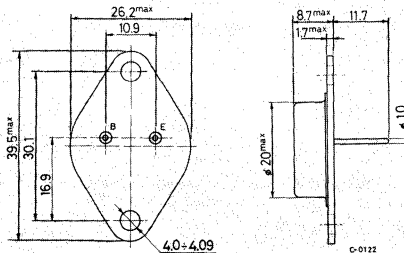

TO-3



BDY57
BDY58

THERMAL DATA

$R_{th\ j-case}$	Thermal resistance junction-case	max	1	°C/W
------------------	----------------------------------	-----	---	------

ELECTRICAL CHARACTERISTICS ($T_{case} = 25^{\circ}C$ unless otherwise specified)

Parameter	Test conditions	Min.	Typ.	Max.	Unit	
I_{CBO}	Collector cutoff current ($I_E = 0$)			1	mA	
I_{CER}	Collector cutoff current			10	mA	
I_{EBO}	Emitter cutoff current ($I_C = 0$)			0.5	mA	
$V_{CEO(sus)}$	*Collector-emitter sustaining voltage	80		125	V	
$V_{(BR)CBO}$	*Collector-base breakdown voltage	120		160	V	
$V_{(BR)EBO}$	*Emitter-base breakdown voltage ($I_C = 0$)	10			V	
$V_{CE\ sat}$	*Collector-emitter saturation voltage	$I_C = 10A$	$I_B = 1A$	0.5	1.4	V
$V_{BE\ sat}$	*Base-emitter saturation voltage	$I_C = 10A$	$I_B = 1A$	1.4	2	V

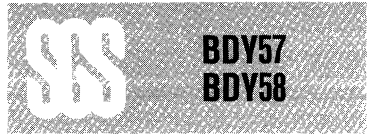

ELECTRICAL CHARACTERISTICS (continued)

Parameter		Test conditions	Min.	Typ.	Max.	Unit
h_{FE}^*	DC current gain	$I_C = 10A$ $V_{CE} = 4V$	20		60	—
		$I_C = 20A$ $V_{CE} = 4V$		15		—
		$T_{case} = -30^{\circ}C$ $I_C = 10A$ $V_{CE} = 4V$	10			—
f_T	Transition frequency	$I_C = 1A$ $V_{CE} = 15V$ $f = 10MHz$	7			MHz
t_{on}	Turn-on time	$I_C = 15A$ $I_{B1} = 1.5A$			1	μs
t_{off}	Turn-off time	$I_C = 15A$ $I_{B1} = -I_{B2} = 1.5A$			2	μs
	Clamped $E_{s/b}$ Collector current	$V_{(clamp)} = 125V$ $L = 500\mu H$	15			A

* Pulsed: pulse duration = 300 μs , duty cycle $\leq 2\%$.

HIGH CURRENT, HIGH SPEED TRANSISTORS

The BDY 90, BDY 91, BDY 92 are silicon multiepitaxial planar NPN transistors in Jedec TO-3 metal case intended for use in switching and linear applications in military and industrial equipment.

ABSOLUTE MAXIMUM RATINGS

		BDY 90	BDY 91	BDY 92
V_{CBO}	Collector-base voltage ($I_E = 0$)	120V	100V	80V
V_{CEV}	Collector-emitter voltage ($V_{BE} = -1,5V$)	120V	100V	80V
V_{CEO}	Collector-emitter voltage ($I_B = 0$)	100V	80V	60V
V_{EBO}	Emitter-base voltage ($I_C = 0$)		6V	
I_C	Collector current		10A	
I_{CM}	Collector peak current		15A	
I_B	Base current		2A	
P_{tot}	Total power dissipation at $T_{case} \leq 25^\circ C$		60W	
T_{stg}	Storage temperature		-65 to 175°C	
T_j	Junction temperature		175°C	

INTERNAL SCHEMATIC DIAGRAM

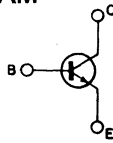

MECHANICAL DATA

Dimensions in mm

Collector connected to case

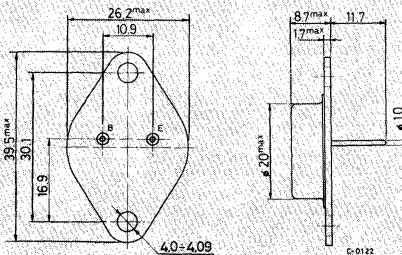

TO-3

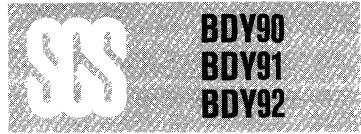

THERMAL DATA

$R_{th\ j-case}$	Thermal resistance junction-case	max	2.5	°C/W
------------------	----------------------------------	-----	-----	------

ELECTRICAL CHARACTERISTICS ($T_{case} = 25^{\circ}C$ unless otherwise specified)

Parameter	Test conditions	Min.	Typ.	Max.	Unit
I_{CBO}	Collector cutoff current ($I_E = 0$)	$V_{CB} = V_{CBO\ max}$		1	mA
I_{CEV}	Collector cutoff current ($V_{BE} = -1.5V$)	$V_{CE} = V_{CEV\ max}$		1	mA
		$T_{case} = 150^{\circ}C$		3	mA
I_{EBO}	Emitter cutoff current ($I_C = 0$)	$V_{EB} = 6V$		1	mA
$V_{CEO\ (sus)}$	*Collector-emitter sustaining voltage ($I_B = 0$)	$I_C = 100mA$ for BDY 90 for BDY 91 for BDY 92		120 100 80	V V V
$V_{CE\ (sat)}$	* Collector-emitter saturation voltage	$I_C = 5A$		0.5	V
		$I_C = 10A$		1.5	V
		for BDY 90, BDY 91 for BDY 92		1	V
$V_{BE\ (sat)}$	* Base-emitter saturation voltage	$I_C = 5A$		1.2	V
		$I_C = 10A$		1.5	V
h_{FE}	* DC current gain	$I_C = 1A$		35	—
		$I_C = 5A$		30	120
		$I_C = 10A$		20	—
f_t	Transition frequency	$I_C = 0.5A$ $f = 5MHz$	$V_{CE} = 5V$	70	MHz
t_{on}	Turn-on time	$I_C = 5A$ $V_{CC} = 30V$	$I_{B1} = 0.5A$	0.35	μs
t_s	Storage time	$I_C = 5A$ $V_{CC} = 30V$	$I_{B1} = -I_{B2} = 0.5A$	1.3	μs
t_f	Fall time			0.2	μs

* Pulsed: pulse duration = 300 μs , duty cycle $\leq 2\%$.



BFX34

EPITAXIAL PLANAR NPN

HIGH CURRENT, GENERAL PURPOSE TRANSISTOR

The BFX 34 is a silicon epitaxial planar NPN transistor in Jedec TO-39 metal case, intended for high current applications.

Very low saturation voltage and high speed at high current levels make it ideal for power drivers, power amplifiers, switching power supplies relay drivers, inverters.

ABSOLUTE MAXIMUM RATINGS

V_{CBO}	Collector-base voltage ($I_E = 0$)	120	V
V_{CEO}	Collector-emitter voltage ($I_B = 0$)	60	V
V_{EBO}	Emitter-base voltage ($I_C = 0$)	6	V
I_C	Collector current	5	A
P_{tot}	Total power dissipation at $T_{amb} \leq 25^\circ\text{C}$ $T_{case} \leq 25^\circ\text{C}$	0.87	W
		5	W
T_{stg}	Storage temperature	-65 to 200	$^\circ\text{C}$
T_j	Junction temperature	200	$^\circ\text{C}$

INTERNAL SCHEMATIC DIAGRAM

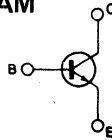

MECHANICAL DATA

Dimensions in mm

Collector connected to case

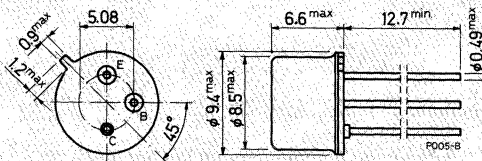

TO-39

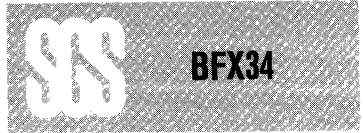

THERMAL DATA

$R_{th\ j-case}$	Thermal resistance junction-case	max	35	°C/W
$R_{th\ j-amb}$	Thermal resistance junction-ambient	max	200	°C/W

ELECTRICAL CHARACTERISTICS ($T_{case} = 25^{\circ}C$ unless otherwise specified)

Parameter	Test conditions	Min.	Typ.	Max.	Unit
I_{CES}	Collector cutoff current ($V_{BE} = 0$)	$V_{CE} = 60V$	0.02	10	μA
I_{EBO}	Emitter cutoff current ($I_C = 0$)	$V_{EB} = 4V$	0.05	10	μA
$V_{(BR)\ CBO}^*$	Collector-base breakdown voltage ($I_E = 0$)	$I_C = 5mA$	120		V
$V_{CEO\ (sus)}^*$	Collector-emitter sustaining voltage ($I_B = 0$)	$I_C = 100mA$	60		V
V_{EBO}^*	Emitter-base voltage ($I_C = 0$)	$I_E = 1\ mA$	6		V
$V_{CE\ (sat)}^*$	Collector-emitter saturation voltage	$I_C = 5A$ $I_B = 0.5A$	0.4	1	V
$V_{BE\ (sat)}^*$	Base-emitter saturation voltage	$I_C = 5A$ $I_B = 0.5A$	1.3	1.6	V
h_{FE}^*	DC current gain	$I_C = 1A$ $V_{CE} = 2V$ $I_C = 1.5A$ $V_{CE} = 0.6V$ $I_C = 2A$ $V_{CE} = 2V$	100 75 40	80	— — 150
f_T	Transition frequency	$I_C = 0.5\ A$ $V_{CE} = 5\ V$ $f = 20\ MHz$	70	100	MHz
C_{EBO}	Emitter-base capacitance	$I_C = 0$ $V_{EB} = 0.5V$ $f = 1\ MHz$	300	500	pF
C_{CBO}	Collector-base capacitance	$I_E = 0$ $V_{CB} = 10V$ $f = 1\ MHz$	40	100	pF
t_{on}	Turn-on time	$I_C = 5\ A$ $V_{CC} = 20\ V$	0.25	0.6	μs
t_{off}	Turn-off time	$I_{B1} = -I_{B2} = 0.5\ A$	0.6	1.2	μs

* Pulsed: pulse duration = 300 μs , duty cycle = 1.5%

Safe operating areas

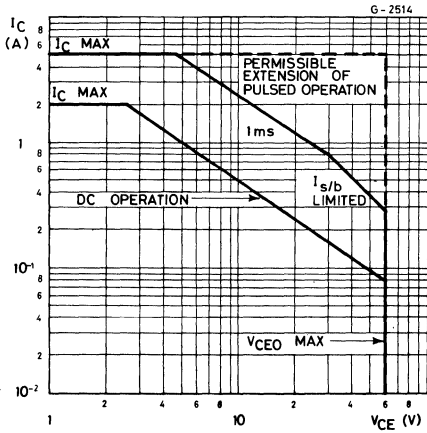

DC current gain

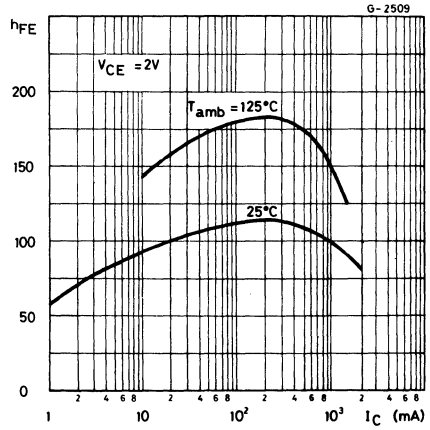

Output characteristics

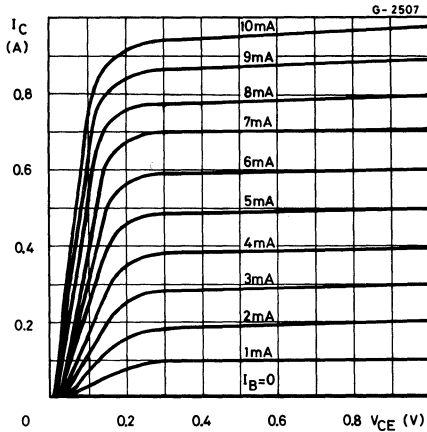

Output characteristics

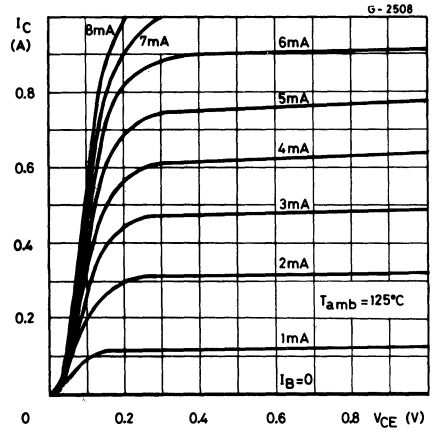

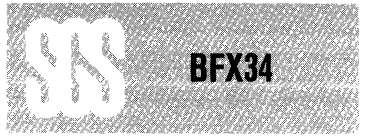

Collector-emitter saturation voltage

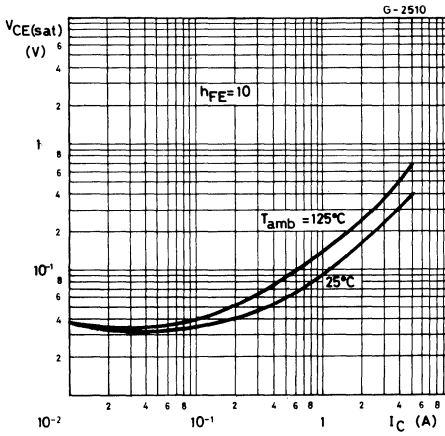

Base-emitter saturation voltage

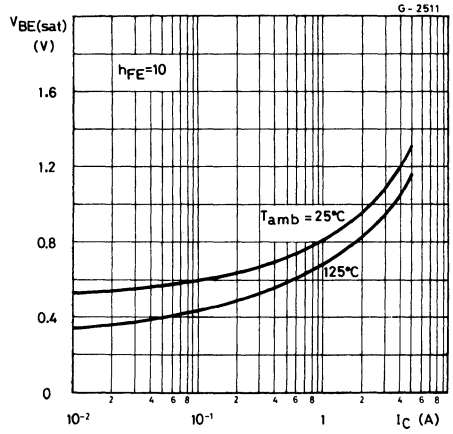

Small signal current gain

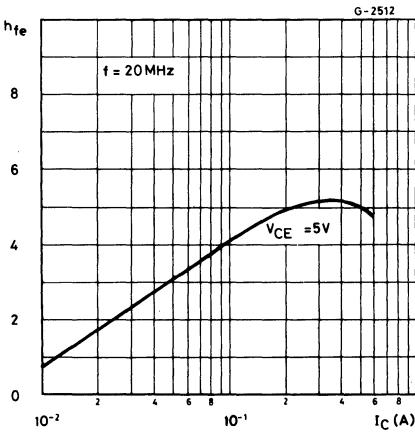

Emitter-base and collector-base capacitances

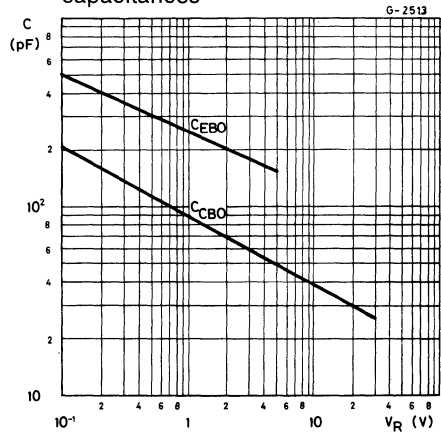



BSS44

EPITAXIAL PLANAR PNP

HIGH CURRENT, GENERAL PURPOSE TRANSISTOR

The BSS 44 is a silicon epitaxial planar PNP transistor in Jedec TO-39 metal case. It is used for high-current switching and power amplifier applications up to 5A.

ABSOLUTE MAXIMUM RATINGS

V_{CBO}	Collector-base voltage ($I_E = 0$)	-65	V
V_{CEO}	Collector-emitter voltage ($I_B = 0$)	-60	V
V_{EBO}	Emitter-base voltage ($I_C = 0$)	-6	V
I_C	Collector current	-5	A
P_{tot}	Total power dissipation at $T_{amb} \leq 25^\circ\text{C}$ $T_{case} \leq 25^\circ\text{C}$	0.87	W
		5	W
T_{stg}	Storage temperature	-65 to 200	$^\circ\text{C}$
T_j	Junction temperature	200	$^\circ\text{C}$

INTERNAL SCHEMATIC DIAGRAM

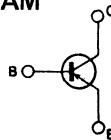

MECHANICAL DATA

Dimensions in mm

Collector connected to case

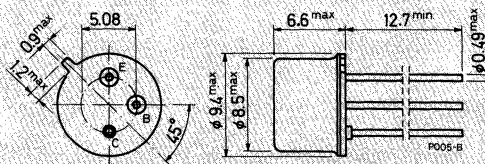

TO-39



THERMAL DATA

$R_{th\ j-case}$	Thermal resistance junction-case	max	35	°C/W
$R_{th\ j-amb}$	Thermal resistance junction-ambient	max	200	°C/W

ELECTRICAL CHARACTERISTICS ($T_{case} = 25^{\circ}C$ unless otherwise specified)

Parameter	Test conditions	Min.	Typ.	Max.	Unit
I_{CES}	Collector cutoff current ($V_{BE} = 0$)			-0.5	μA
$V_{(BR)\ CBO}$	Collector-base breakdown voltage ($I_E = 0$)			-65	V
$V_{CEO\ (sus)}^*$	Collector-emitter sustaining voltage ($I_B = 0$)			-60	V
V_{EBO}^*	Emitter-base voltage ($I_C = 0$)			-6	V
$V_{CE\ (sat)}^*$	Collector-emitter saturation voltage	$I_C = -0.5A$ $I_C = -5A$	$I_B = -50mA$ $I_B = -0.5A$	-0.1 -0.4 -1	V V
$V_{BE\ (sat)}^*$	Base-emitter saturation voltage	$I_C = -0.5A$ $I_C = -5A$	$I_B = -50mA$ $I_B = -0.5A$	-0.8 -1.1 -1.6	V V
h_{FE}^*	DC current gain	$I_C = -0.5A$ $I_C = -2A$ $I_C = -5A$	$V_{CE} = -2V$ $V_{CE} = -2V$ $V_{CE} = -2V$	30 40 70 45	— — —
f_T	Transition frequency	$I_C = -0.5A$	$V_{CE} = -5V$	80	MHz
C_{CBO}	Collector-base capacitance	$I_E = 0$ $f = 1\ MHz$	$V_{CB} = -10\ V$	100	pF
t_{on}	Turn-on time	$I_C = -0.5A$	$V_{CC} = -20V$	0.065	μs
t_{off}	Turn-off time	$I_{B1} = -I_{B2} = -50mA$		0.45	μs

* Pulsed: pulse duration = 300 μs , duty cycle = 1.5%



BSS44

Safe operating areas

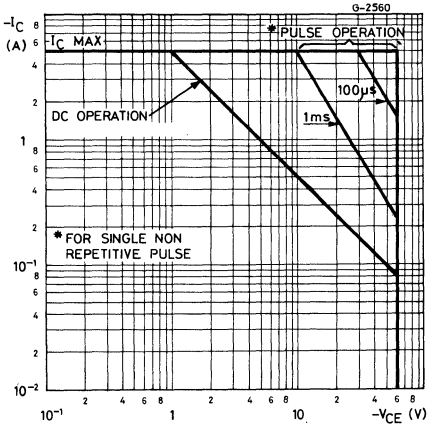

DC current gain

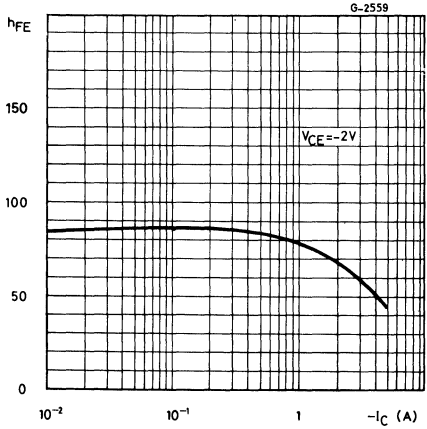

Collector-emitter saturation voltage

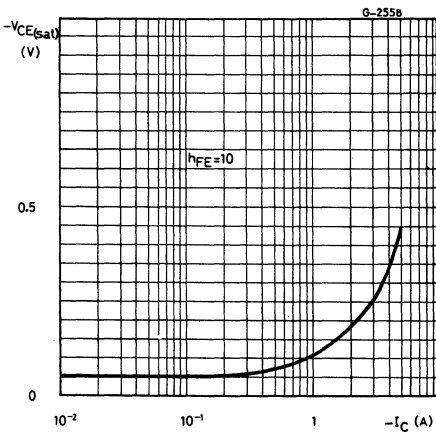

Base-emitter saturation voltage

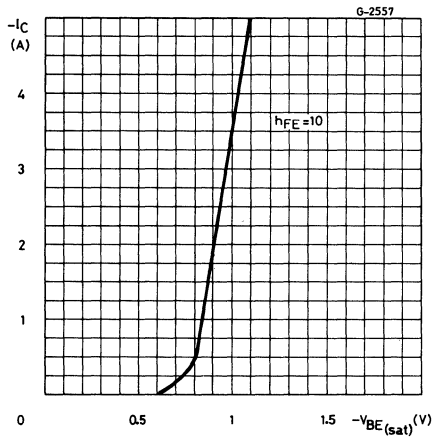



Transition frequency

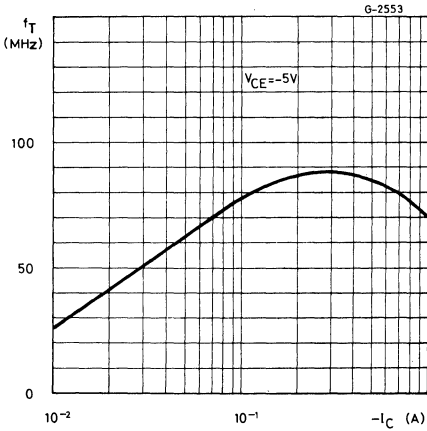

Collector-base capacitance

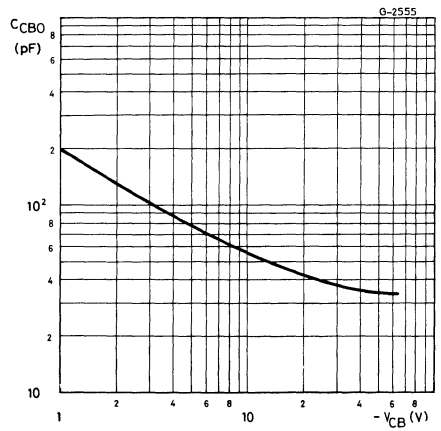

Saturated switching characteristics

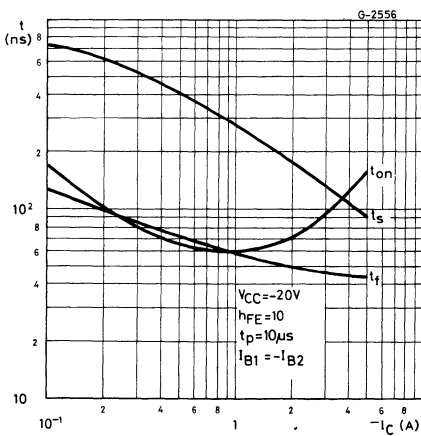

Power rating chart

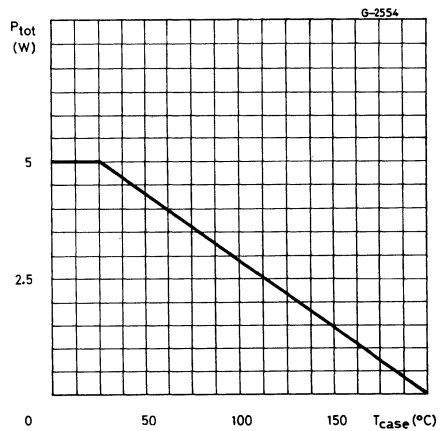



BSW67
BSW68

EPITAXIAL PLANAR NPN

HIGH VOLTAGE SWITCH

The BSW 67 and BSW 68 are silicon epitaxial planar NPN transistors in Jedec TO-39 metal case. They are intended for high voltage inductive load switching applications.

ABSOLUTE MAXIMUM RATINGS

		BSW 67	BSW 68
V_{CBO}	Collector-base voltage ($I_E = 0$)	120V	150V
V_{CEO}	Collector-emitter voltage ($I_B = 0$)	120V	150V
I_C	Collector current		1.5A
I_{CM}	Collector peak current		2A
P_{tot}	Total power dissipation at $T_{amb} \leq 45^\circ\text{C}$		0.7W
	$T_{case} \leq 25^\circ\text{C}$		5W
	$T_{case} \leq 100^\circ\text{C}$		2.85W
T_{stg}	Storage temperature	-65 to 200 °C	
T_j	Junction temperature	200 °C	

INTERNAL SCHEMATIC DIAGRAM

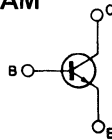

MECHANICAL DATA

Dimensions in mm

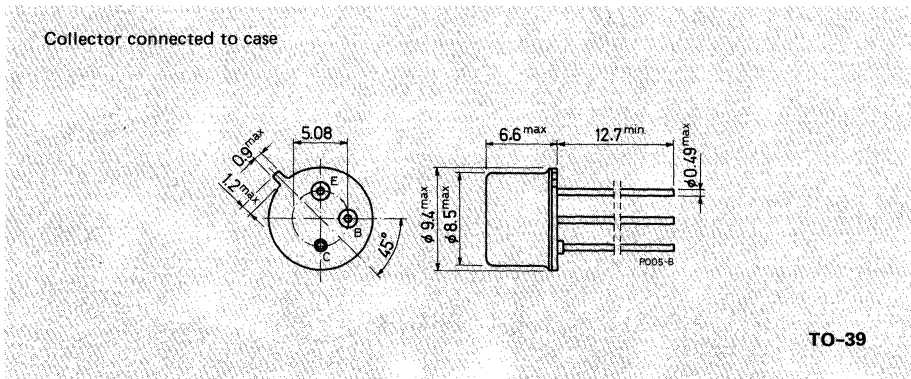



THERMAL DATA

$R_{th\ j-case}$	Thermal resistance junction-case	max	35	°C/W
$R_{th\ j-amb}$	Thermal resistance junction-ambient	max	220	°C/W

ELECTRICAL CHARACTERISTICS ($T_{case} = 25^{\circ}C$ unless otherwise specified)

Parameter	Test conditions	Min.	Typ.	Max.	Unit
I_{CBO}	Collector cutoff current ($I_E = 0$) for BSW 67 $V_{CB} = 60\ V$ $V_{CB} = 60\ V$ $T_{case} = 150^{\circ}C$ for BSW 68 $V_{CB} = 75\ V$ $V_{CB} = 75\ V$ $T_{case} = 150^{\circ}C$			100 50 100 50	nA μA nA μA
$V_{(BR)\ CBO}$	Collector-base breakdown voltage ($I_E = 0$) $I_C = 100\ \mu A$ for BSW 67 for BSW 68	120 150			V V
$V_{CEO(sus)}$ *	Collector-emitter sustaining voltage ($I_B = 0$) $I_C = 100\ mA$ for BSW 67 for BSW 68	120 150			V V
V_{EBO} *	Emitter-base voltage ($I_C = 0$) $I_E = 100\ \mu A$	6			V
$V_{CE(sat)}$ *	Collector-emitter saturation voltage $I_C = 0.1\ A$ $I_B = 0.01\ A$ $I_C = 0.5\ A$ $I_B = 0.05\ A$ $I_C = 1\ A$ $I_B = 0.15\ A$		0.15 0.5 1		V V V
$V_{BE(sat)}$ *	Base-emitter voltage $I_C = 0.1\ A$ $I_B = 0.01\ A$ $I_C = 0.5\ A$ $I_B = 0.05\ A$ $I_C = 1\ A$ $I_B = 0.15\ A$		0.9 1.1 1.2		V V V
h_{FE} *	DC current gain $I_C = 0.1\ A$ $V_{CE} = 5\ V$ $I_C = 0.5\ A$ $V_{CE} = 5\ V$ $I_C = 1\ A$ $V_{CE} = 5\ V$	40 30 15			— — —
f_T	Transition frequency $I_C = 100\ mA$ $V_{CE} = 20\ V$	80			MHz
C_{CBO}	Collector-base capacitance $I_E = 0$ $V_{CB} = 10\ V$ $f = 1\ MHz$		35		pF
t_{on}	Turn-on time $I_C = 0.5\ A$ $V_{CC} = 20\ V$	0.3			μs
t_{off}	Turn-off time $I_{B1} = -I_{B2} = 0.05\ A$	1			μs

* Pulsed: pulse duration = 300 μs , duty cycle = 1.5%

Safe operating areas

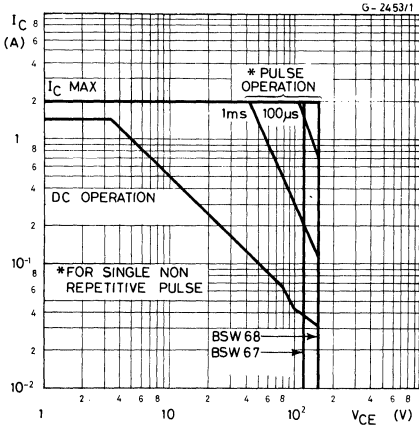

DC current gain

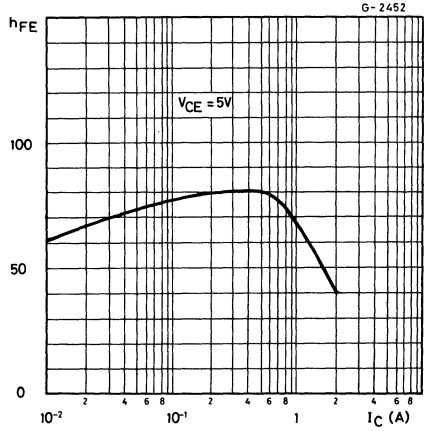

Collector-emitter saturation voltage

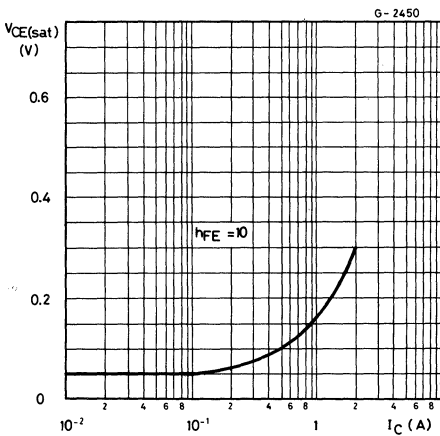

Base-emitter saturation voltage

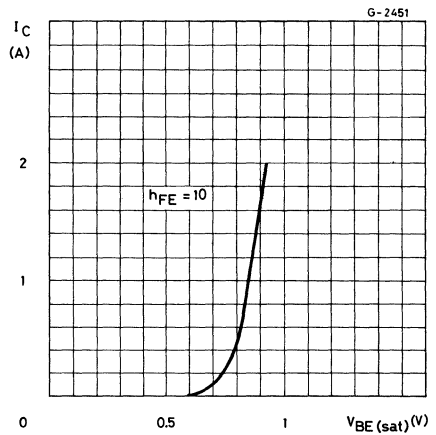

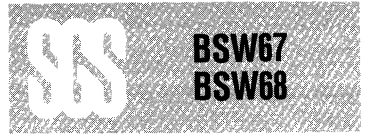

Transition frequency

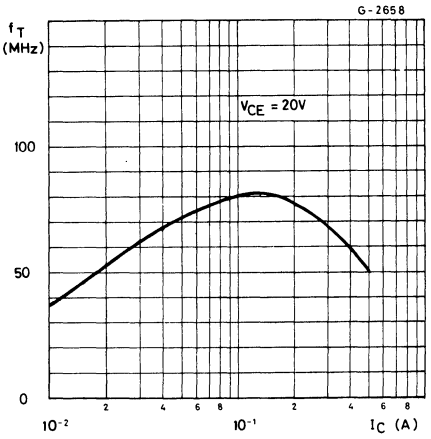

Collector-base capacitance

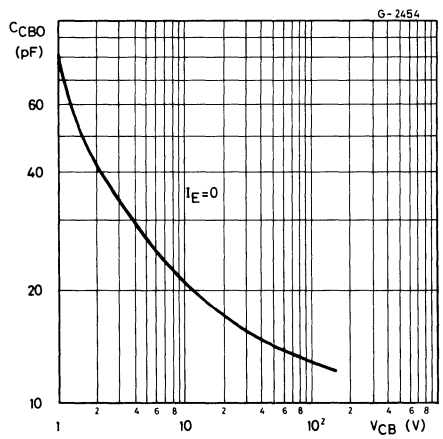

Saturated switching characteristics

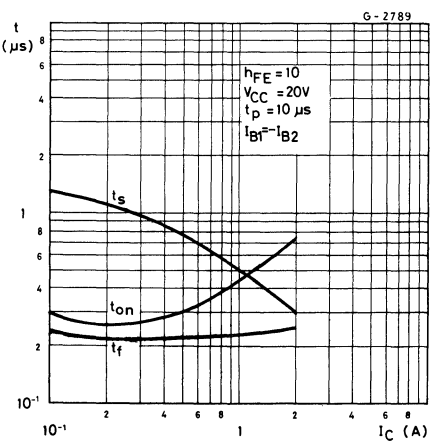

Power rating chart

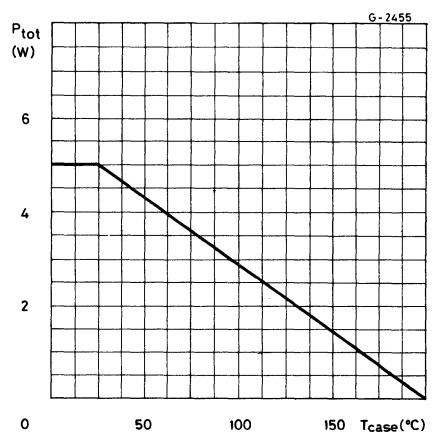



BU125

EPITAXIAL PLANAR NPN

HIGH CURRENT, GENERAL PURPOSE TRANSISTOR

The BU 125 is a silicon epitaxial planar NPN transistor in Jedec TO-39 metal case. It is used in TV horizontal output and general purpose applications.

ABSOLUTE MAXIMUM RATINGS

V_{CBO}	Collector-base voltage ($I_E = 0$)	130	V
V_{CEO}	Collector-emitter voltage ($I_B = 0$)	60	V
V_{EBO}	Emitter-base voltage ($I_C = 0$)	6	V
I_C	Collector current	7	A
P_{tot}	Total power dissipation at $T_{amb} \leq 25^\circ\text{C}$ $T_{case} \leq 50^\circ\text{C}$	1	W
		10	W
T_{stg}	Storage temperature	-65 to 200	$^\circ\text{C}$
T_j	Junction temperature	200	$^\circ\text{C}$

INTERNAL SCHEMATIC DIAGRAM

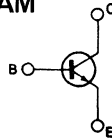

MECHANICAL DATA

Dimensions in mm

Collector connected to case

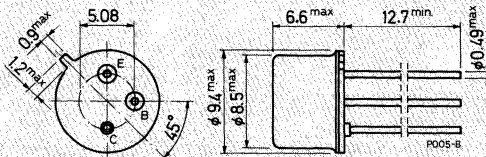

TO-39

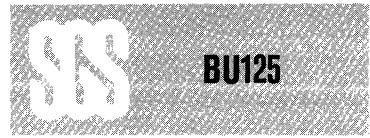

THERMAL DATA

$R_{th\ j-case}$	Thermal resistance junction-case	max	15	°C/W
$R_{th\ j-amb}$	Thermal resistance junction-ambient	max	175	°C/W

ELECTRICAL CHARACTERISTICS ($T_{case} = 25^{\circ}C$ unless otherwise specified)

Parameter	Test conditions	Min.	Typ.	Max.	Unit	
I_{CBO}	Collector cutoff current ($I_E = 0$)	$V_{CB} = 100\ V$		0.02 10	μA	
$V_{(BR)\ CBO}^*$	Collector-base breakdown voltage ($I_E = 0$)	$I_C = 1\ mA$		130	V	
$V_{(BR)\ CES}^*$	Collector-emitter breakdown voltage ($V_{BE} = 0$)	$I_C = 1\ mA$		130	V	
$V_{CEO(sus)}^*$	Collector-emitter sustaining voltage ($I_B = 0$)	$I_C = 50\ mA$		60	V	
V_{EBO}^*	Emitter-base voltage ($I_C = 0$)	$I_E = 1\ mA$		5	V	
$V_{CE(sat)}^*$	Collector-emitter saturation voltage	$I_C = 1\ A$ $I_C = 5\ A$	$I_B = 0.1\ A$ $I_B = 0.5\ A$	0.25 1.2	V V	
$V_{BE(sat)}^*$	Base-emitter saturation voltage	$I_C = 1\ A$ $I_C = 5\ A$	$I_B = 0.1\ A$ $I_B = 0.5\ A$	0.9 1.3	1 1.6	V V
h_{FE}^*	DC current gain	$I_C = 0.1\ A$ $I_C = 5\ A$	$V_{CE} = 2\ V$ $V_{CE} = 2\ V$	40 15	155 60	— —
f_T	Transition frequency	$I_C = 0.5\ A$	$V_{CE} = 5\ V$	50	MHz	
C_{CBO}	Collector-base capacitance	$I_E = 0$ $f = 1\ MHz$	$V_{CB} = 10\ V$	80	pF	
t_{off}	Turn-off time	$I_C = 5\ A$ $I_{B1} = -I_{B2} = 0.5\ A$	$V_{CC} = 20\ V$	0.65	μs	

* Pulsed: pulse duration = 300 μs , duty cycle = 1.5%



BU125

Safe operating areas

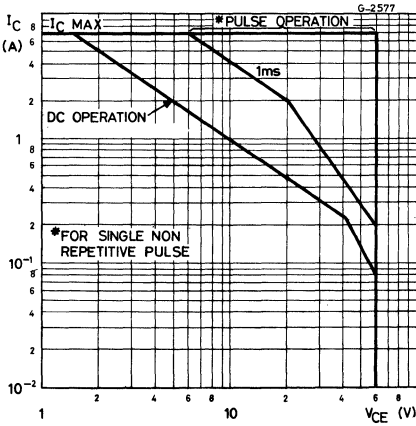

DC current gain

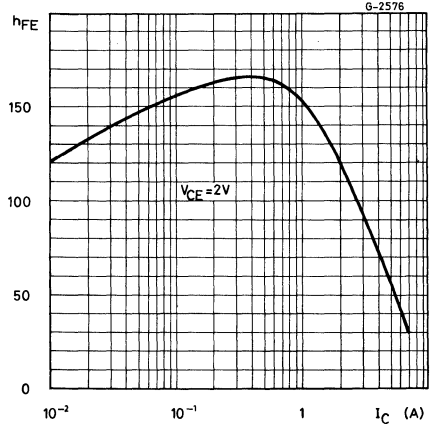

Collector-emitter saturation voltage

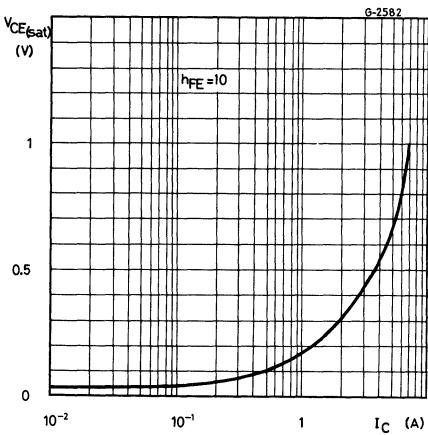

Base-emitter saturation voltage

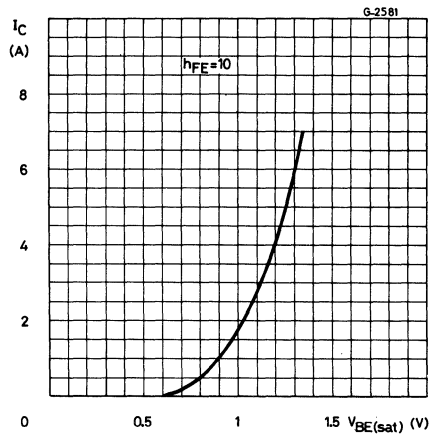

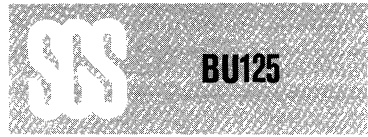

Transition frequency

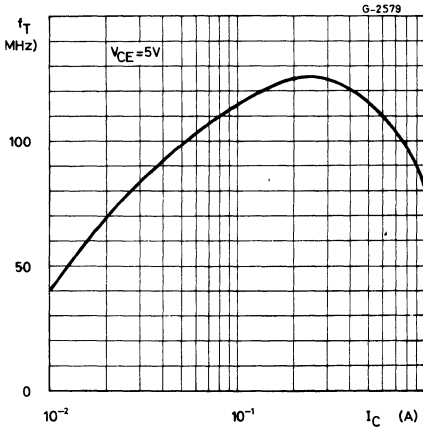

Collector-base capacitance

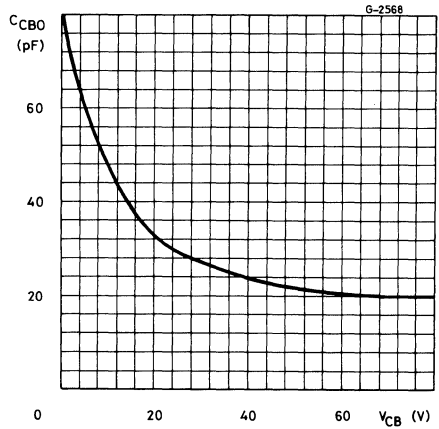

Saturated switching characteristics

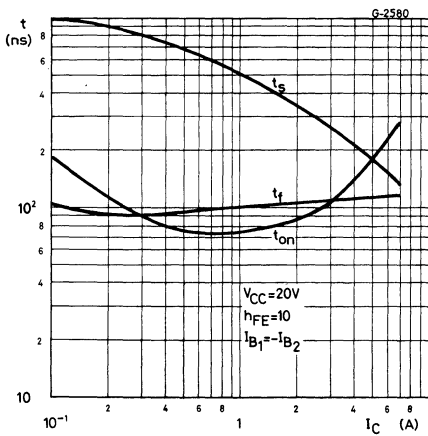

Power rating chart

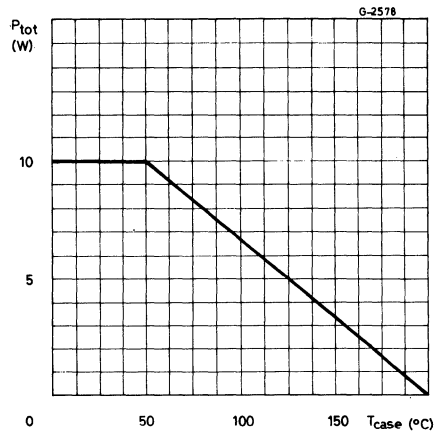



BU125S

EPITAXIAL PLANAR NPN

HIGH VOLTAGE POWER AMPLIFIER

The BU 125S is a silicon epitaxial planar NPN transistor in Jedec TO-39 metal case. It is intended for general purpose, linear and switching applications.

ABSOLUTE MAXIMUM RATINGS

V_{CBO}	Collector-base voltage ($I_E = 0$)	250	V
V_{CEV}	Collector-emitter voltage ($V_{BE} = -1.5V$)	250	V
V_{CEO}	Collector-emitter voltage ($I_B = 0$)	150	V
V_{EBO}	Emitter-base voltage ($I_C = 0$)	6	V
I_C	Collector current	3	A
I_{CM}	Collector peak current (repetitive)	5	A
I_B	Base current	0.5	A
P_{tot}	Total power dissipation at $T_{amb} \leq 25^\circ C$	1	W
		10	W
T_{stg}	Storage temperature	-65 to 200	$^\circ C$
T_j	Junction temperature	200	$^\circ C$

INTERNAL SCHEMATIC DIAGRAM

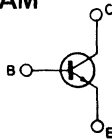

MECHANICAL DATA

Dimensions in mm

Collector connected to case

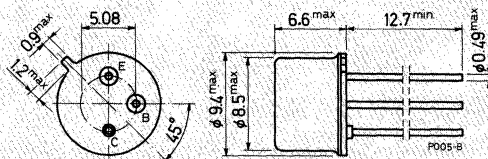

TO-39



THERMAL DATA

$R_{th\ j-case}$	Thermal resistance junction-case	max	15	°C/W
$R_{th\ j-amb}$	Thermal resistance junction-ambient	max	175	°C/W

ELECTRICAL CHARACTERISTICS ($T_{case} = 25^{\circ}C$ unless otherwise specified)

Parameter	Test conditions	Min.	Typ.	Max.	Unit
I_{CBO}	Collector cutoff current ($I_E = 0$)			10	μA
I_{EBO}	Emitter cutoff current ($I_C = 0$)			1	mA
V_{CBO}	Collector-base voltage ($I_E = 0$)			250	V
$V_{CEO(sus)}$ *	Collector-emitter sustaining voltage ($I_B = 0$)			150	V
$V_{CE(sat)}$	Collector-emitter saturation voltage			1.5	V
h_{FE}	DC current gain	$I_C = 5\text{ mA}$ $I_C = 250\text{ mA}$	$V_{CE} = 10\text{ V}$ $V_{CE} = 3\text{ V}$	30 30	— —
f_T	Transition frequency	$I_C = 100\text{ mA}$	$V_{CE} = 10\text{ V}$	15	MHz
C_{CBO}	Collector-base capacitance	$I_E = 0$ $f = 1\text{ MHz}$	$V_{CB} = 20\text{ V}$	35	pF
t_{on}	Turn-on time	$I_C = 0.5\text{ A}$	$V_{CC} = 20\text{ V}$	0.3	μs
t_{off}	Turn-off time	$I_{B1} = -I_{B2} = 0.05\text{ A}$		1	μs

* Pulsed: pulse duration = 300 μs , duty cycle = 1.5%

Safe operating areas

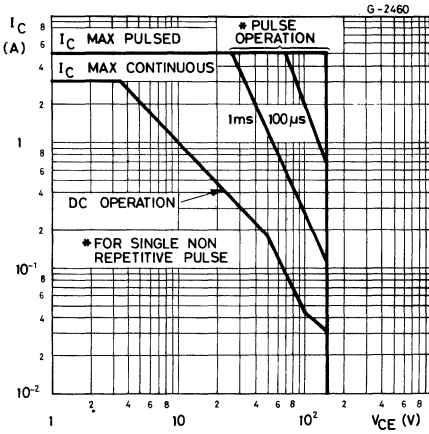

DC current gain

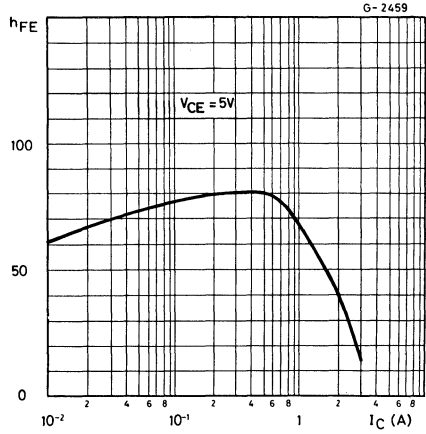

Collector-emitter saturation voltage

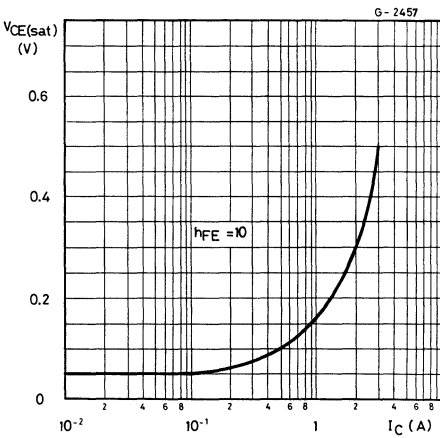

Base-emitter saturation voltage

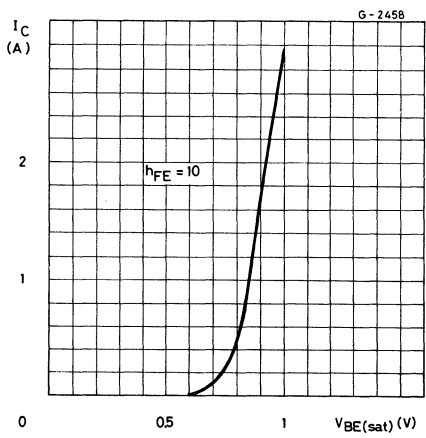



Transition frequency

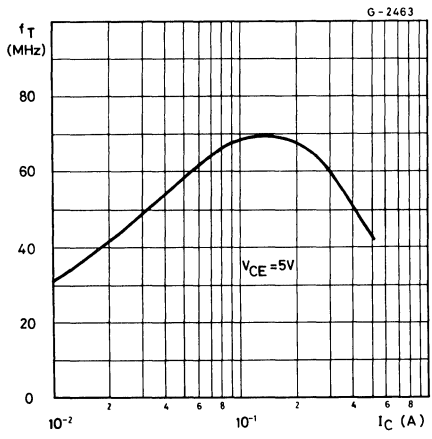

Collector-base capacitance

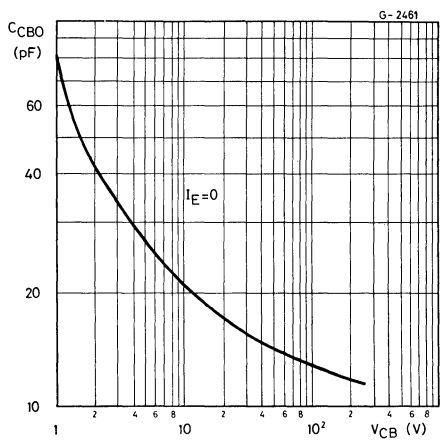

Saturated switching characteristics

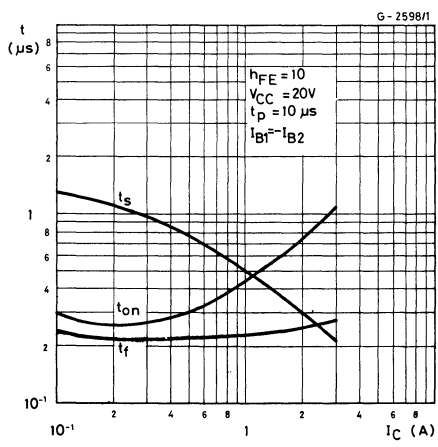

Power rating chart

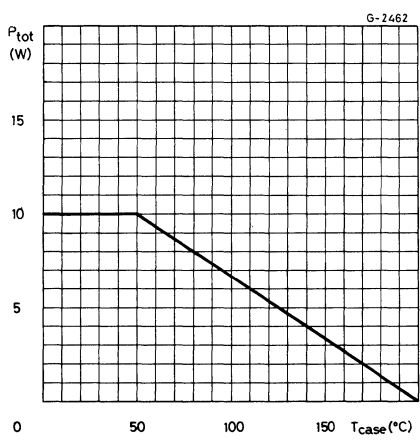



BU325

EPITAXIAL PLANAR NPN

HIGH VOLTAGE SWITCH

The BU 325 is a silicon planar epitaxial NPN transistor in Jedec TO-126 plastic case. It is intended for high voltage, high current linear and switching applications.

ABSOLUTE MAXIMUM RATINGS

V_{CBO}	Collector-base voltage ($I_E = 0$)	200	V
V_{CEO}	Collector-emitter voltage ($I_B = 0$)	200	V
V_{EBO}	Emitter-base voltage ($I_C = 0$)	5	V
I_C	Collector current	3	A
I_B	Base current	1	A
P_{tot}	Total power dissipation at $T_{amb} \leq 25^\circ C$ $T_{case} \leq 25^\circ C$	1.25	W
		25	W
T_{stg}	Storage temperature	-65 to 150	$^\circ C$
T_j	Junction temperature	150	$^\circ C$

INTERNAL SCHEMATIC DIAGRAM

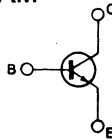

MECHANICAL DATA

Dimensions in mm

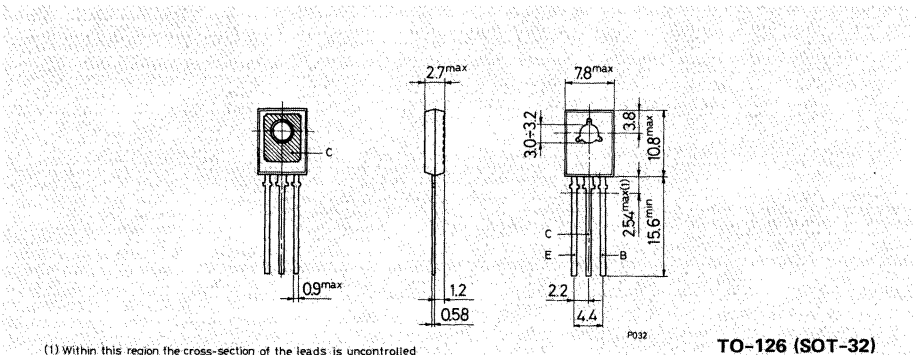



THERMAL DATA

$R_{th\ j-case}$	Thermal resistance junction-case	max	5	°C/W
$R_{th\ j-amb}$	Thermal resistance junction-amb.	max	100	°C/W

ELECTRICAL CHARACTERISTICS ($T_{case} = 25^{\circ}C$ unless otherwise specified)

Parameter	Test conditions	Min.	Typ.	Max.	Unit
I_{CBO}	Collector cutoff current ($I_E=0$)		100		μA
V_{CBO}	Collector base breakdown voltage ($I_E=0$)	200			V
$V_{CEO(sus)}$	*Collector-emitter sustaining voltage ($I_B = 0$)	200			V
V_{EBO}^*	Emitter-base voltage ($I_C=0$)	5			V
$V_{CE(sat)}^*$	Collector-emitter saturation voltage		0.06	1.0	V
			0.10	1.5	V
$V_{BE(sat)}^*$	Base-emitter saturation voltage		0.73	1.0	V
			0.80	1.2	V
h_{FE}^*	DC current gain		30	200	—
			30	200	—
			30	200	—

ELECTRICAL CHARACTERISTICS (continued)

Parameter		Test conditions	Min. Typ. Max.	Unit
f_T	Transition frequency	$I_C = 500\text{mA}$ $V_{CE} = 5\text{V}$	40	MHz
C_{CBO}	Collector-base capacitance	$I_E = 0$ $V_{CB} = 10\text{V}$ $f = 1\text{MHz}$	50	pF
t_{on}	Turn-on time	$I_C = 0.5\text{A}$ $I_{B1} = 50\text{mA}$ $V_{CC} = 20\text{V}$	0.3	μs
t_{off}	Turn-off time	$I_C = 0.5\text{A}$ $I_{B1} = -I_{B2} = 50\text{mA}$ $V_{CC} = 20\text{V}$	1	μs

* Pulsed: pulse duration = 300 μs , duty cycle = 1.5%

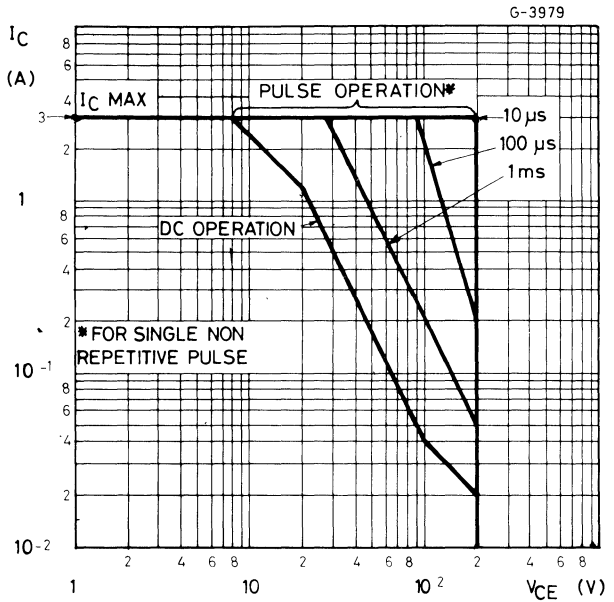
Safe operating areas

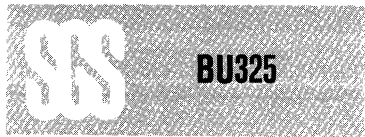

DC current gain

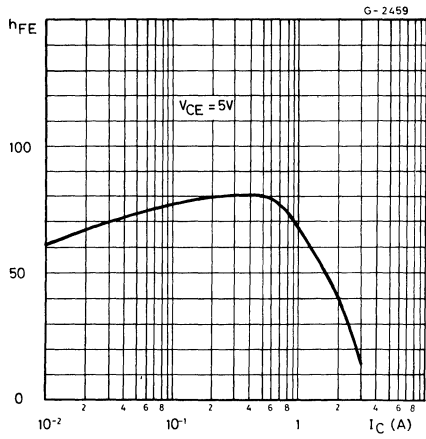

Collector-emitter saturation voltage

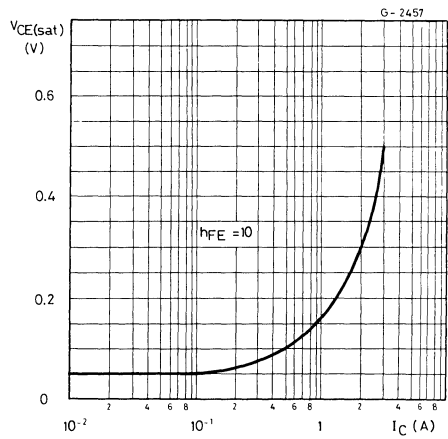

Base-emitter saturation voltage

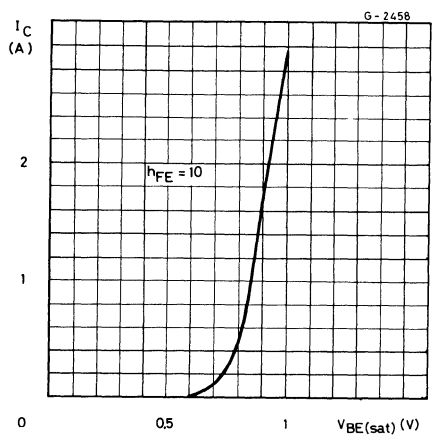

Transition frequency

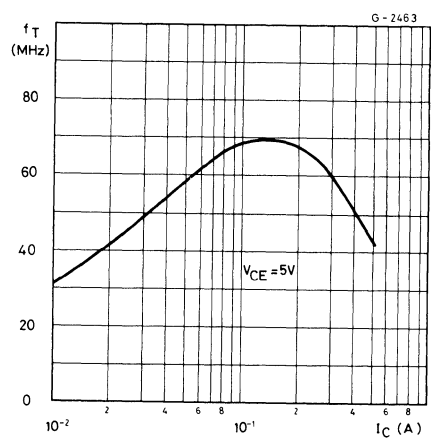



BU325

Collector-emitter saturation voltage

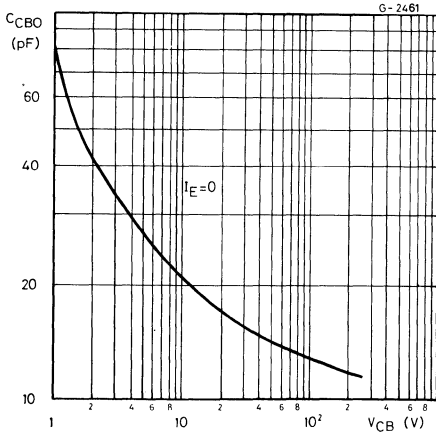

Saturated switching characteristics

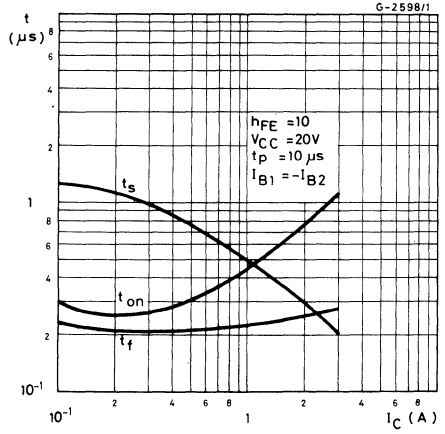

Power rating chart

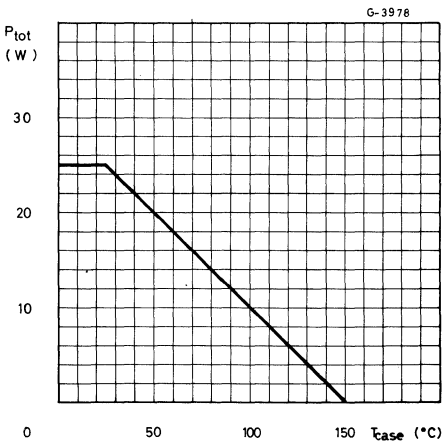



MULTIEPITAXIAL MESA NPN

HIGH VOLTAGE POWER SWITCH

The BU 326 is a silicon multiepitaxial mesa NPN transistor in a Jedec TO-3 metal case particularly intended for switch-mode CTV supply system.

ABSOLUTE MAXIMUM RATINGS

V_{CES}	Collector-emitter voltage ($V_{BE}=0$)	800	V
V_{CEO}	Collector-emitter voltage ($I_B=0$)	375	V
V_{EBO}	Base-emitter voltage ($I_C=0$)	10	V
I_C	Collector current	6	A
I_{CM}	Collector peak current	8	A
I_B	Base current	3	A
P_{tot}	Total power dissipation at $T_{case} \leq 25^\circ C$	75	W
T_{stg}	Storage temperature	-65 to 200	$^\circ C$
T_j	Junction temperature	200	$^\circ C$

INTERNAL SCHEMATIC DIAGRAM

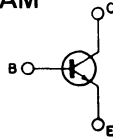

MECHANICAL DATA

Dimensions in mm

Collector connected to case

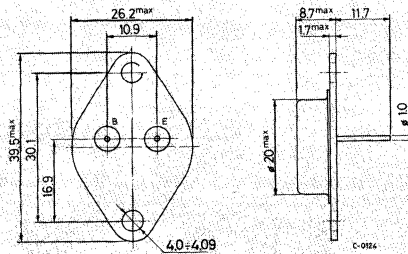

TO-3

**BU326****THERMAL DATA**

$R_{th\ j-case}$	Thermal resistance junction-case	max	2.33	°C/W
------------------	----------------------------------	-----	------	------

ELECTRICAL CHARACTERISTICS ($T_{case} = 25^{\circ}C$ unless otherwise specified)

Parameter	Test conditions	Min.	Typ.	Max.	Unit
I_{CES} Collector cutoff current ($V_{BE}=0$)	$V_{CE}=800V$ $V_{CE}=800V$ $T_{case}=125^{\circ}C$			1 2	mA mA
I_{EBO} Emitter cutoff current ($I_C=0$)	$V_{EB}=10V$			10	mA
$V_{CEO(sus)}$ *Collector-emitter sustaining voltage ($I_B = 0$)	$I_C = 100mA$			325	V
$V_{CE(sat)}$ * Collector-emitter saturation voltage	$I_C = 2.5A$ $I_B = 0.5A$ $I_C = 4A$ $I_B = 1.25A$			1.5 3	V V
$V_{BE(sat)}$ * Base-emitter saturation voltage	$I_C = 2.5A$ $I_B = 0.5A$ $I_C = 4A$ $I_B = 1.25A$			1.4 1.6	V V
h_{FE} * DC current gain	$I_C = 1A$ $V_{CE}=5V$			25	—
t_{on} Turn-on time	$I_C = 2.5A$ $I_{B1} = 0.5A$ $V_{CC}=250V$			0.5	μs
t_s Storage time	$I_C = 2.5A$ $I_{B1} = 0.5A$ $I_{B2} = -1A$ $V_{CC}=250V$			3.5	μs
t_f Fall time	$I_C = 2.5A$ $I_{B1} = 0.5A$ $I_{B2} = -1A$ $V_{CC}=250V$			0.5	μs

* Pulsed: pulse duration = 300 μs , duty cycle = 1.5%

Safe operating areas

- I — Area of permissible operation during turn-on provided $R_{BE} \leq 100\Omega$ and $t_p \leq 0.6 \mu s$
- II — Area of permissible operation with $V_{BE} \leq 0$ and $t_p \leq 2 \mu s$

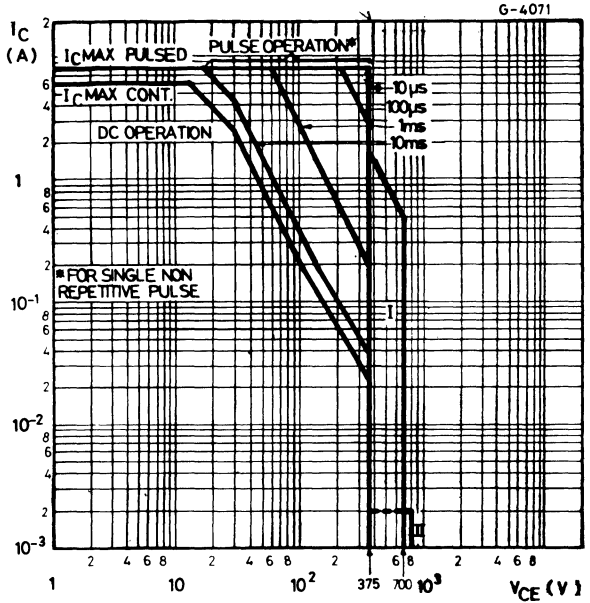

Derating curves

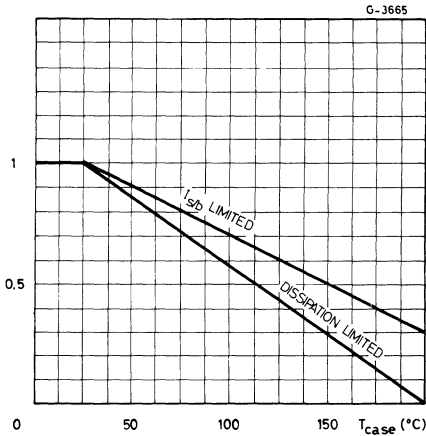

Thermal transient response

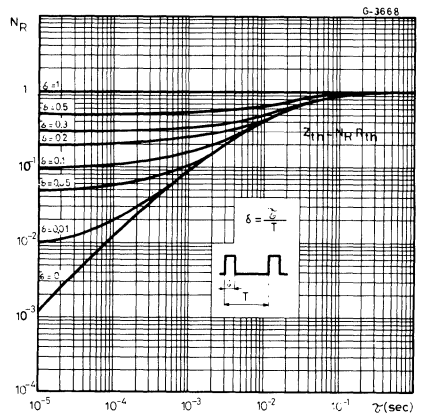



BU326

DC current gain

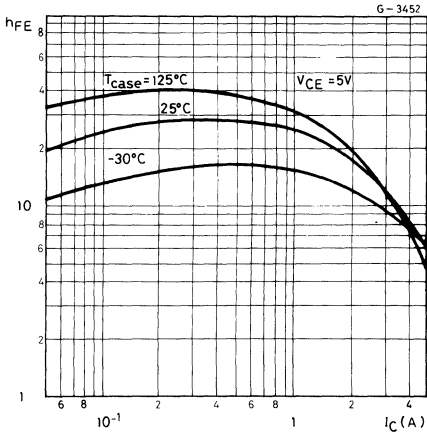

Collector-emitter saturation voltage

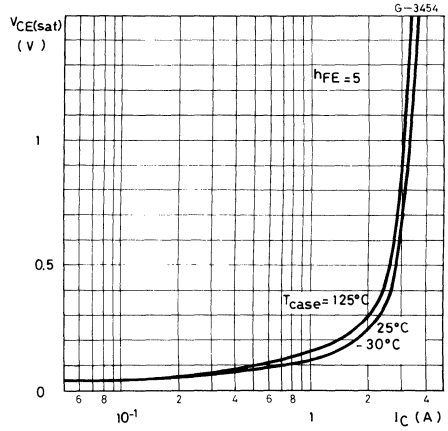

Collector-emitter saturation voltage

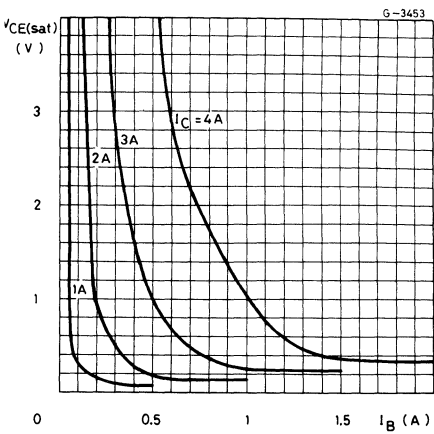

Base-emitter saturation voltage

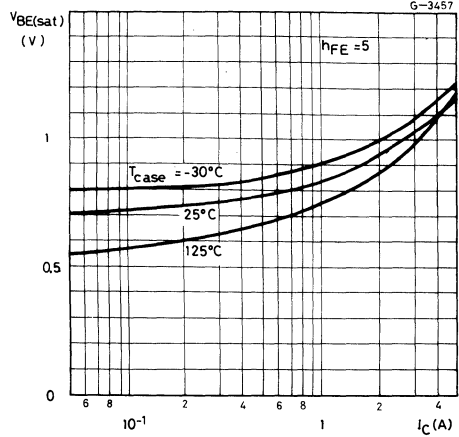

Saturated switching characteristics

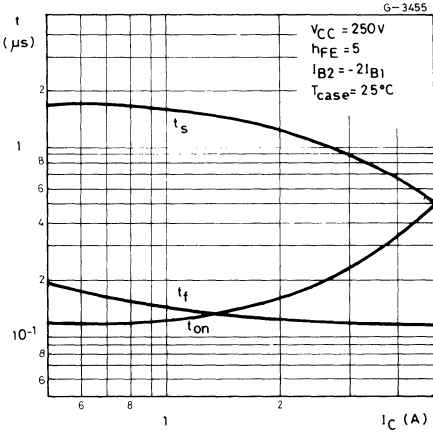

Saturated switching characteristics

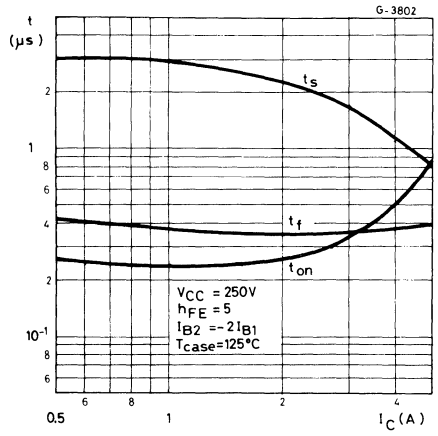



BU326A

MULTIEPITAXIAL MESA NPN

HIGH VOLTAGE POWER SWITCH

The BU 326A is a silicon multiepitaxial mesa NPN transistor in Jedec TO-3 metal case particularly intended for switch-mode CTV supply system.

ABSOLUTE MAXIMUM RATINGS

V_{CES}	Collector-emitter voltage ($V_{BE}=0$)	900	V
V_{CEO}	Collector-emitter voltage ($I_B=0$)	400	V
V_{EBO}	Emitter-base voltage ($I_C=0$)	10	V
I_C	Collector current	6	A
I_{CM}	Collector peak current	8	A
I_B	Base current	3	A
P_{tot}	Total power dissipation at $T_{case} \leq 25^\circ C$	75	W
T_{stg}	Storage temperature	-65 to 200	$^\circ C$
T_j	Junction temperature	200	$^\circ C$

INTERNAL SCHEMATIC DIAGRAM

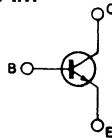

MECHANICAL DATA

Dimensions in mm

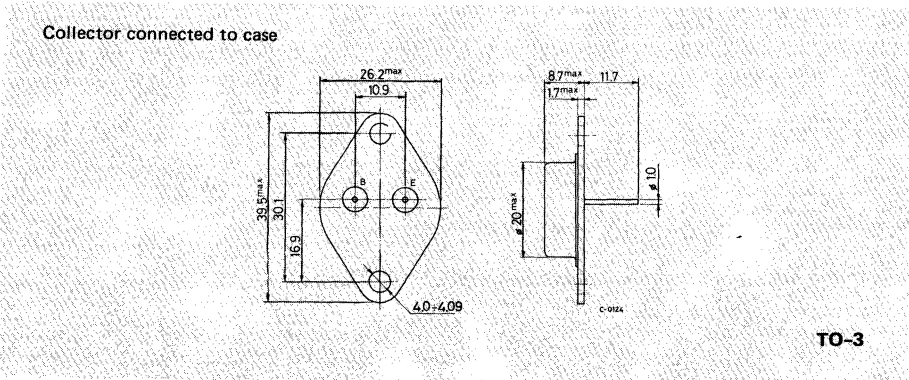



THERMAL DATA

$R_{th\ j-case}$ Thermal resistance junction-case	max 2.33 °C/W
---	---------------

ELECTRICAL CHARACTERISTICS ($T_{case} = 25^{\circ}C$ unless otherwise specified)

Parameter	Test conditions	Min. Typ. Max.	Unit
I_{CES} Collector cutoff current ($V_{BE}=0$)	$V_{CE}=900V$ $V_{CE}=900V$ $T_{case}=125^{\circ}C$	1 2	mA mA
I_{EBO} Emitter cutoff current ($I_C=0$)	$V_{EB}=10V$	10	mA
$V_{CEO(sus)}$ *Collector-emitter sustaining voltage ($I_B = 0$)	$I_C = 100mA$	400	V
$V_{CE(sat)}$ * Collector-emitter saturation voltage	$I_C = 2.5A$ $I_B = 0.5A$ $I_C = 4A$ $I_B = 1.25A$	1.5 3	V V
$V_{BE(sat)}$ * Base-emitter saturation voltage	$I_C = 2.5A$ $I_B = 0.5A$ $I_C = 4A$ $I_B = 1.25A$	1.4 1.6	V V
h_{FE} * DC current gain	$I_C = 1A$ $V_{CE}=5V$	25	—
t_{on} Turn-on time	$I_C = 2.5A$ $I_{B1} = 0.5A$ $V_{CC}=250V$	0.5	μs
t_s Storage time	$I_C = 2.5A$ $I_{B1} = 0.5A$ $I_{B2} = -1A$ $V_{CC}=250V$	3.5	μs
t_f Fall time	$I_C = 2.5A$ $I_{B1} = 0.5A$ $I_{B2} = -1A$ $V_{CC}=250V$	0.5	μs

* Pulsed: pulse duration = 300 μs , duty cycle = 1.5%



BU326A

Safe operating areas

- I — Area of permissible operation during turn-on provided $R_{BE} = 100\Omega$ and $t_p \leq 0.6 \mu s$
- II — Area of permissible operation with $V_{BE} \leq 0$ and $t_p \leq 2 \mu s$

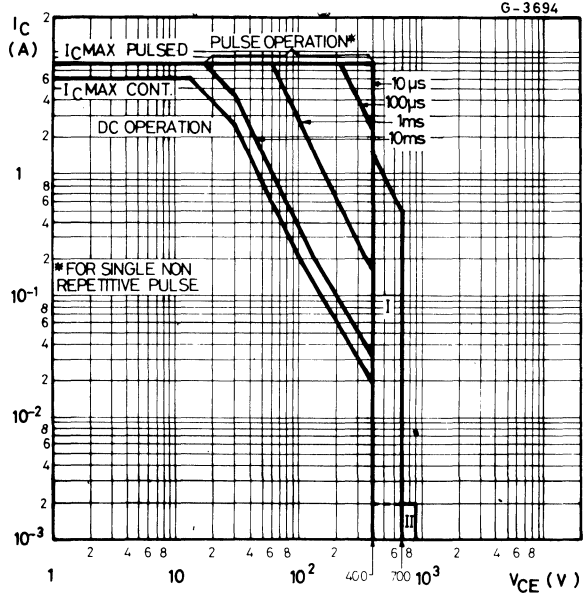

Derating curves

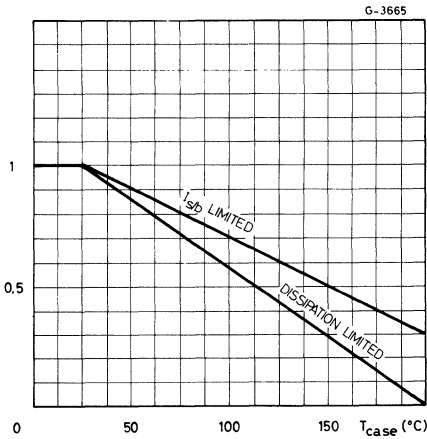

Thermal transient response

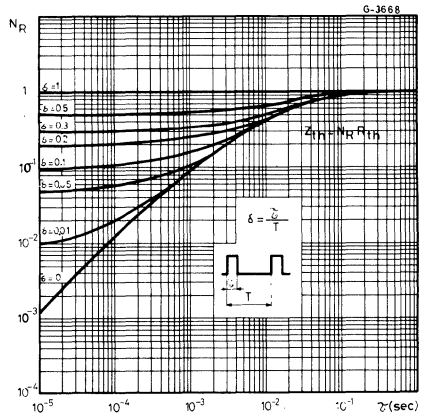



DC current gain

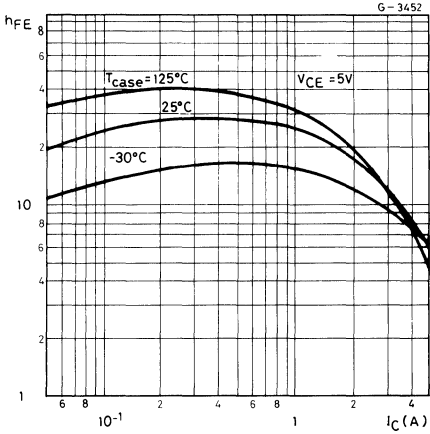

Collector-emitter saturation voltage

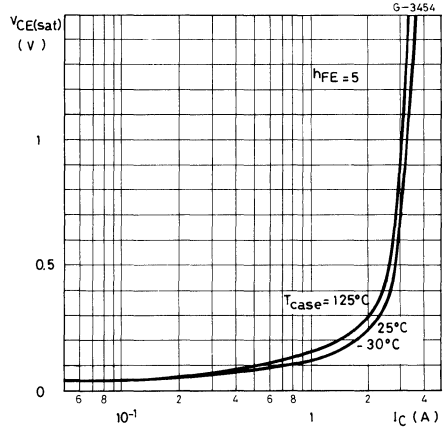

Collector-emitter saturation voltage

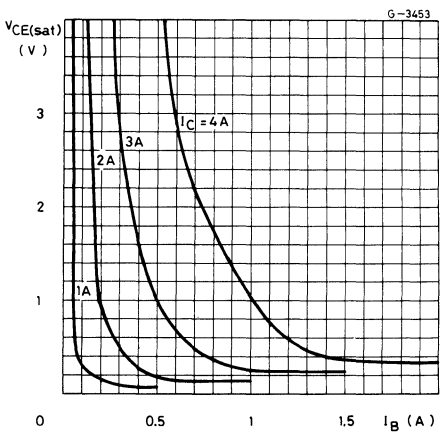

Base-emitter saturation voltage

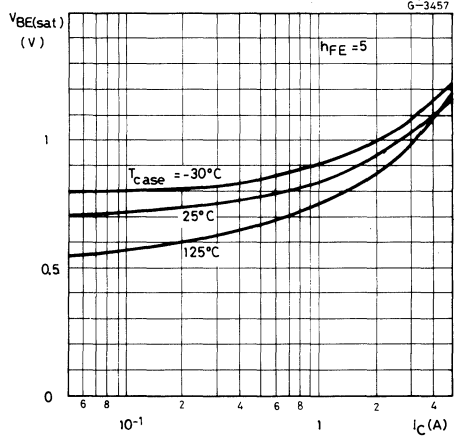



BU326A

Saturated switching characteristics

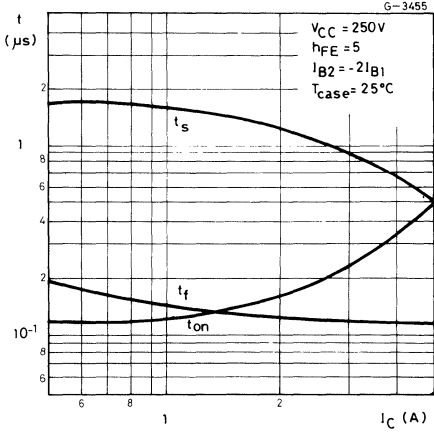

Saturated switching characteristics

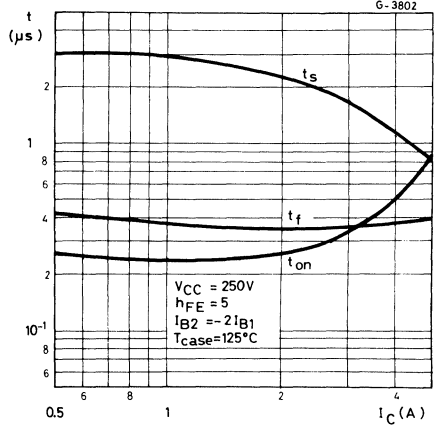

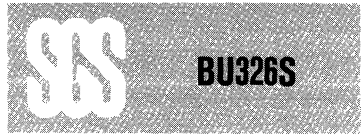

MULTIEPITAXIAL MESA NPN

HIGH VOLTAGE POWER SWITCH

The BU 326S is a silicon multiepitaxial NPN transistor in Jedec TO-3 metal case, particularly intended for switch-mode CTV applications.

ABSOLUTE MAXIMUM RATINGS

V_{CES}	Collector-emitter voltage ($V_{BE} = 0$)	800	V
V_{CEO}	Collector-emitter voltage ($I_B = 0$)	400	V
V_{EBO}	Emitter-base voltage ($I_C = 0$)	7	V
I_C	Collector current	6	A
I_{CM}	Collector peak current	8	A
I_B	Base current	3	A
P_{tot}	Total power dissipation at $T_{case} \leq 75^\circ\text{C}$	60	W
T_{stg}	Storage temperature	-65 to 175	$^\circ\text{C}$
T_J	Junction temperature	175	$^\circ\text{C}$

INTERNAL SCHEMATIC DIAGRAM

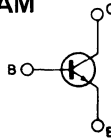

MECHANICAL DATA

Dimensions in mm

Collector connected to case

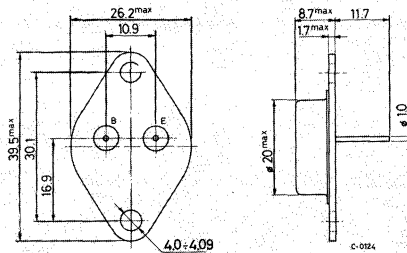

TO-3

**BU326S****THERMAL DATA**

$R_{th\ j-case}$	Thermal resistance junction-case	max	1.67	°C/W
------------------	----------------------------------	-----	------	------

ELECTRICAL CHARACTERISTICS ($T_{case} = 25^{\circ}C$ unless otherwise specified)

Parameter		Test conditions	Min.	Typ.	Max.	Unit
I_{CES}	Collector cutoff current ($V_{BE} = 0$)	$V_{CE} = 800\ V$			1	mA
		$V_{CE} = 800\ V$ $T_{case} = 150^{\circ}C$			3	mA
I_{EBO}	Emitter cutoff current ($I_C = 0$)	$V_{EB} = 7\ V$			1	mA
$V_{CEO(sus)}$ *	Collector-emitter sustaining voltage ($I_B = 0$)	$I_C = 100\ mA$	400			V
$V_{CE(sat)}$ *	Collector-emitter saturation voltage	$I_C = 2.5\ A$ $I_B = 0.5\ A$			1.5	V
		$I_C = 4\ A$ $I_B = 1.25\ A$			3	V
$V_{BE(sat)}$ *	Base-emitter saturation voltage	$I_C = 2.5\ A$ $I_B = 0.5\ A$			1.4	V
		$I_C = 4\ A$ $I_B = 1.25\ A$			1.8	V
h_{FE} *	DC current gain	$I_C = 4\ A$ $V_{CE} = 5\ V$	3.5	10		—
f_T	Transition frequency	$I_C = 0.5\ A$ $V_{CE} = 10\ V$		20		MHz
t_{on}	Turn-on time	$I_C = 2.5\ A$ $V_{CC} = 250\ V$ $I_{B1} = 0.5\ A$		0.3		μs
t_s	Storage time	$I_C = 2.5\ A$ $V_{CC} = 250\ V$ $I_{B1} = 0.5\ A$ $I_{B2} = -1\ A$		1.8		μs
t_f	Fall time			0.3		μs

* Pulsed: pulse duration = 300 μs , duty cycle = 1.5%

Safe operating areas

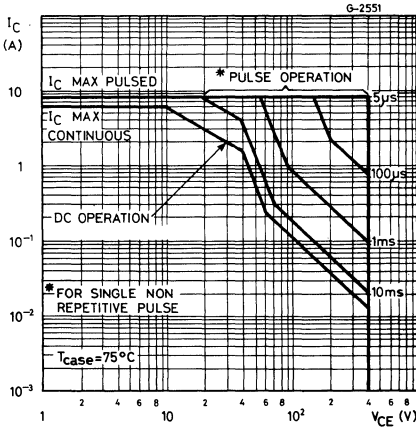

DC current gain

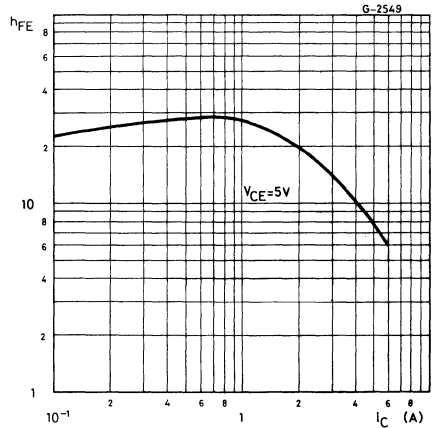

Collector-emitter saturation voltage

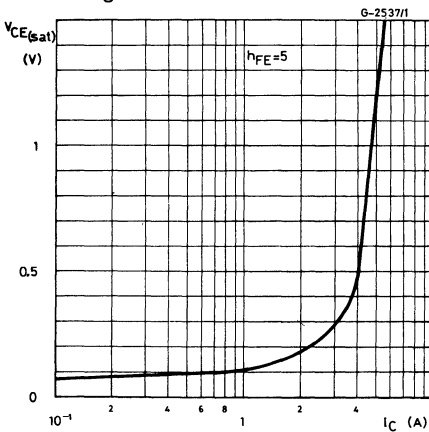

Collector-emitter saturation voltage

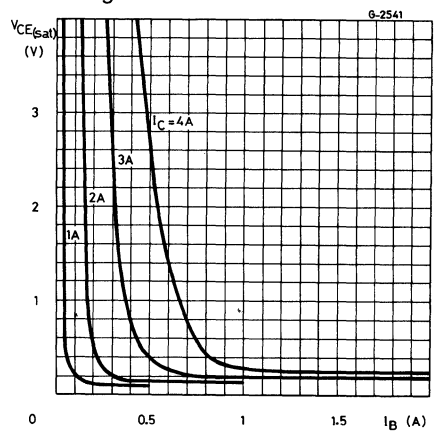



BU326S

Base-emitter saturation voltage

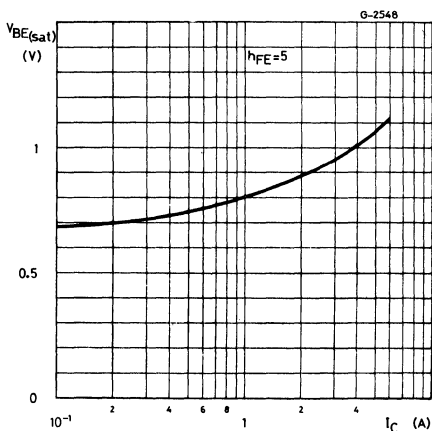

Small signal current gain

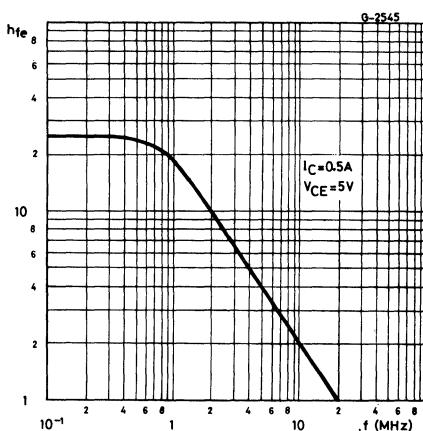

Collector-base capacitance

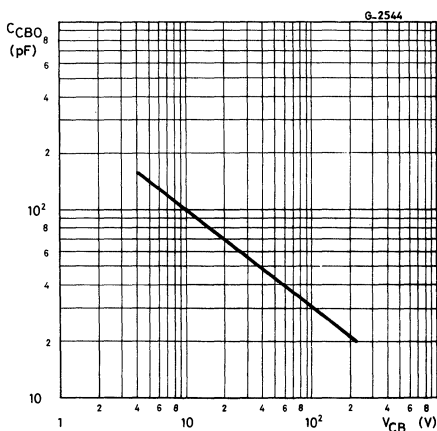

Saturated switching characteristics

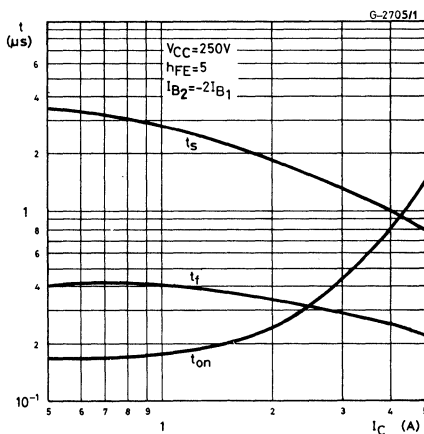

EPITAXIAL PLANAR NPN



HORIZONTAL TV DEFLECTORS

The BU 406, BU 406H and BU 408 are silicon epitaxial planar NPN transistors in Jedec TO-220 plastic package. They are fast switching, high voltage devices for use in horizontal deflection output stages of large screen MTV receivers with 110° CRT.

ABSOLUTE MAXIMUM RATINGS

V_{CBO}	Collector-base voltage ($I_E = 0$)	400	V
V_{CEV}	Collector-emitter voltage ($V_{BE} = -1.5V$)	400	V
V_{CEO}	Collector-emitter voltage ($I_B = 0$)	200	V
V_{EBO}	Emitter-base voltage ($I_C = 0$)	6	V
I_C	Collector current	7	A
I_{CM}	Collector peak current (repetitive)	10	A
I_{CM}	Collector peak current ($t = 10$ ms)	15	A
I_B	Base current	4	A
P_{tot}	Total power dissipation at $T_{case} \leq 25^\circ C$	60	W
T_{stg}	Storage temperature	-65 to 150	$^\circ C$
T_j	Junction temperature	150	$^\circ C$

INTERNAL SCHEMATIC DIAGRAM

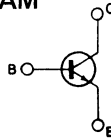

MECHANICAL DATA

Dimensions in mm

Collector connected to tab.

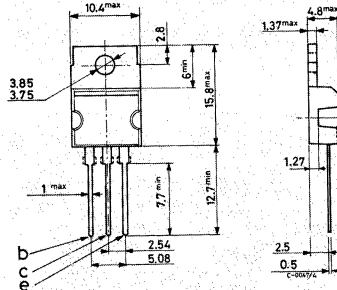

TO-220



BU406
BU406H
BU408

THERMAL DATA

$R_{th\ j-case}$	Thermal resistance junction-case	max	2.08	°C/W
$R_{th\ j-amb}$	Thermal resistance junction-ambient	max	70	°C/W

ELECTRICAL CHARACTERISTICS ($T_{case} = 25^{\circ}C$ unless otherwise specified)

Parameter	Test conditions	Min.	Typ.	Max.	Unit
I_{CES}	Collector cutoff current ($V_{BE} = 0$)	$V_{CE} = 400\ V$ $V_{CE} = 250\ V$ $V_{CE} = 250\ V$		5 100 1	mA μA mA
I_{EBO}	Emitter cutoff current ($I_C = 0$)	$V_{EB} = 6\ V$		1	mA
$V_{CE(sat)}^*$	Collector-emitter saturation voltage	for BU406 $I_C = 5\ A$ for BU406H $I_C = 5\ A$ for BU408 $I_C = 6\ A$	$I_B = 0.5\ A$ $I_B = 0.8\ A$ $I_B = 1.2\ A$	1 1 1	V V V
$V_{BE(sat)}^*$	Base-emitter saturation voltage	for BU406 $I_C = 5\ A$ for BU406H $I_C = 5\ A$ for BU408 $I_C = 6\ A$	$I_B = 0.5\ A$ $I_B = 0.8\ A$ $I_B = 1.2\ A$	1.2 1.2 1.5	V V V
f_T	Transition frequency	$I_C = 0.5\ A$	$V_{CE} = 10\ V$	10	MHz
t_{off}^{**}	Turn-off time	for BU406 $I_C = 5\ A$ for BU406H $I_C = 5\ A$ for BU408 $I_C = 6\ A$	$I_{B\ end} = 0.5A$ $I_{B\ end} = 0.8A$ $I_{B\ end} = 1.2A$	0.75 0.4 0.4	μs μs μs
$I_{s/b}$	Second breakdown collector current	$V_{CE} = 40\ V$	$t = 10ms$	4	A

* Pulsed: pulse duration = 300 μs , duty cycle = 1.5%

** See test circuit



DC current gain

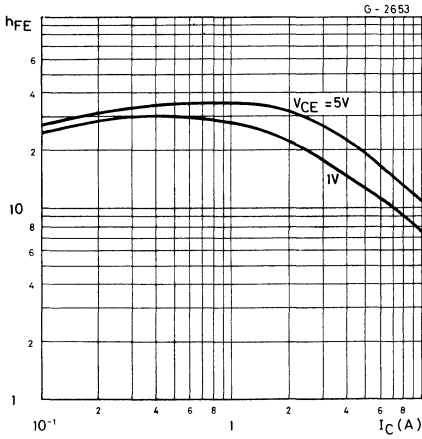

Collector-emitter saturation voltage

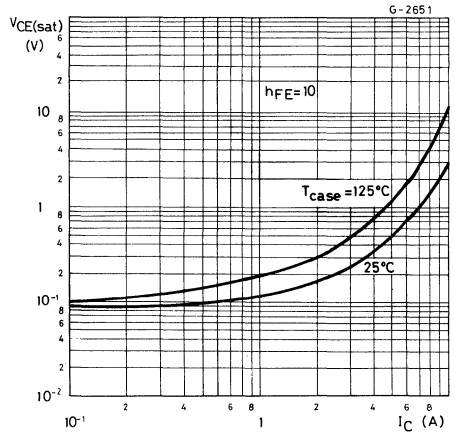

Base-emitter saturation voltage

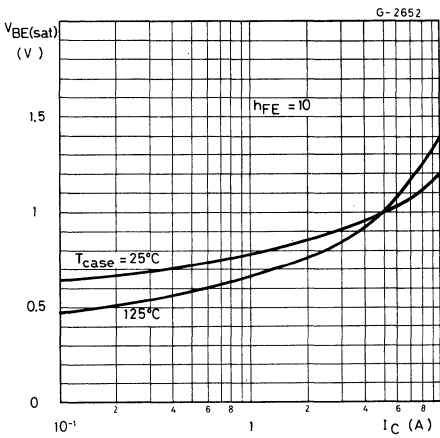

Collector cutoff current

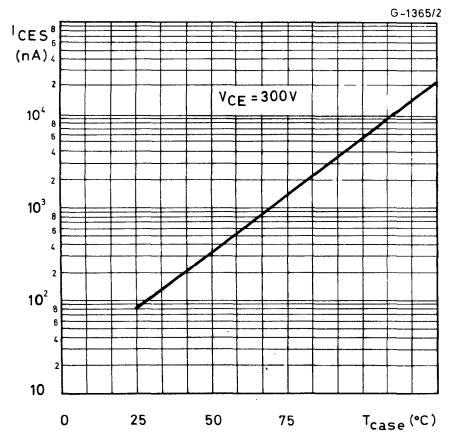



BU406
BU406H
BU408

Storage time

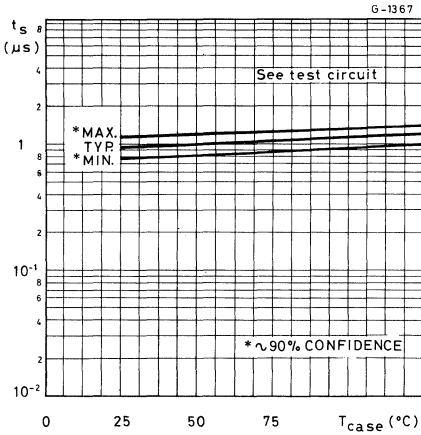

Fall time

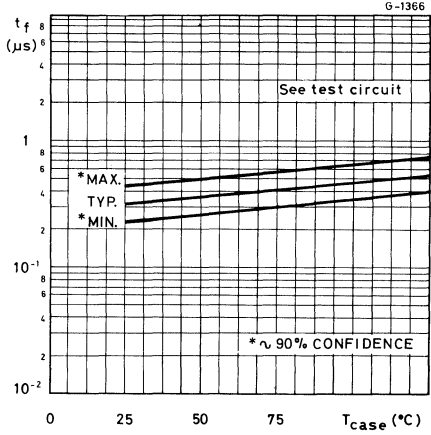

Turn-off time

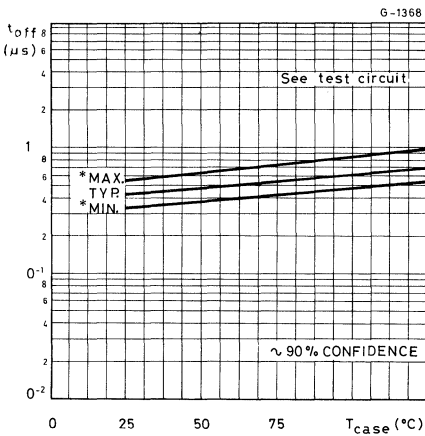



SWITCHING TIMES

Test circuit (fall, storage and turn-off time)

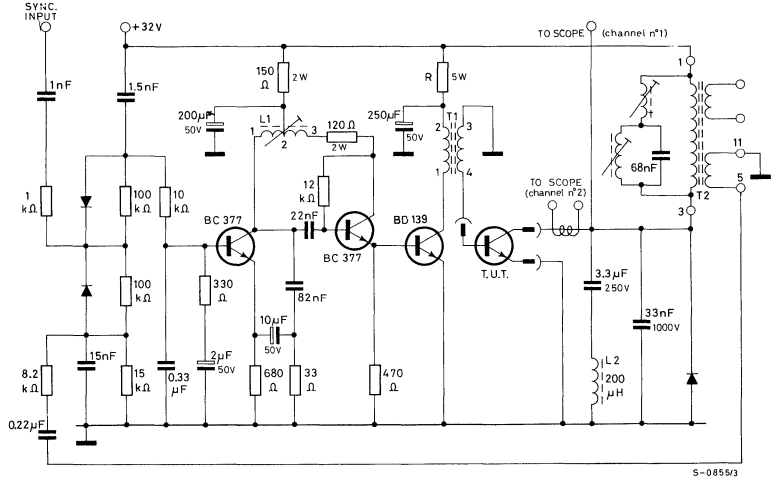

- L1 Horizontal hold coil: Pins 1-2=75 turns \varnothing 0.2mm; R=1.5 Ω ; L min=0.62 mH
Pins 2-3=293 turns \varnothing 0.2mm; R=4.8 Ω ; L max=4.1 mH Core=siferrit B 62120 25X4X2
- L2 Horizontal yoke=200 μ H
- T1 Driver transformer: Pins 1-2=125 turns \varnothing 0.2mm;
Pins 3-4=25 turns \varnothing 0.4mm; Gap =0.12mm; Core=3E3 double E 19x15x5
- T2 EHT transformer manufacturer ARCO type 249.065/035
- R = 340 Ω for BU406
R = 220 Ω for BU406H
R = 180 Ω for BU408

Waveforms

Fall and storage time

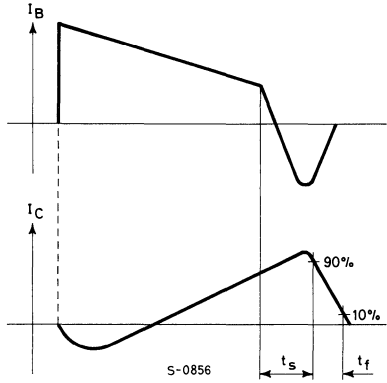

Turn-off time

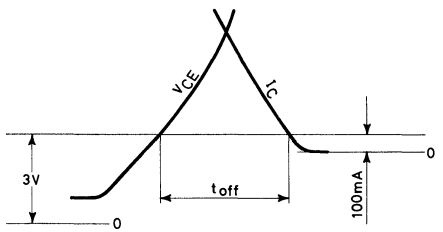

Turn-off time is the time for the collector current I_C to decrease to 100mA after the collector to emitter voltage V_{CE} has risen 3V into its flyback excursion



BU406
BU406H
BU408

APPLICATION INFORMATION

BU 406 - application circuit for 17" to 24" - 110° - 28 mm neck picture tubes

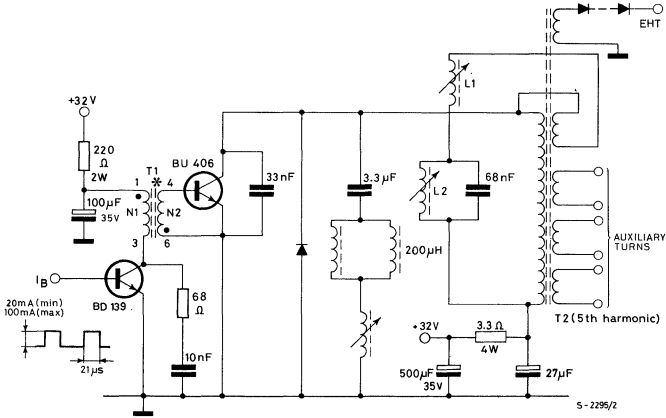

*N1=125 turns ϕ 0.3mm; N2=25 turns ϕ 0.6mm; GAP=0.12mm; CORE=DOUBLE E 19x5x8 mm; FERRITE 3E1TYPE

EPITAXIAL PLANAR NPN



HORIZONTAL TV DEFLECTORS

The BU 406D, BU 407D and BU 408D are silicon planar epitaxial NPN transistors with integrated damper diode, in Jedec TO-220 plastic package. They are fast switching, high voltage devices for use in horizontal deflection output stages of MTV receivers with 110° CRT.

The BU 406D and BU 408D are primarily intended for large screen, while the BU 407D is for medium and small screens.

ABSOLUTE MAXIMUM RATINGS

		BU406D	BU407D	BU408D
V_{CBO}	Collector-base voltage ($I_E = 0$)	400V	330V	400V
V_{CEV}	Collector-emitter voltage ($V_{BE} = -1.5V$)	400V	330V	400V
V_{EBO}	Emitter-base voltage ($I_C = 0$)		6V	
I_C	Collector current		7A	
I_{CM}	Collector peak current (repetitive)		10A	
I_{CM}	Collector peak current ($t = 10$ ms)		15A	
I_B	Base current		4A	
P_{tot}	Total power dissipation at $T_{case} \leq 25$ °C		60W	
T_{stg}	Storage temperature		-65 to 150 °C	
T_j	Junction temperature		150 °C	

INTERNAL SCHEMATIC DIAGRAM

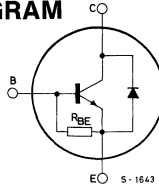

MECHANICAL DATA

Dimensions in mm

Collector connected to tab.

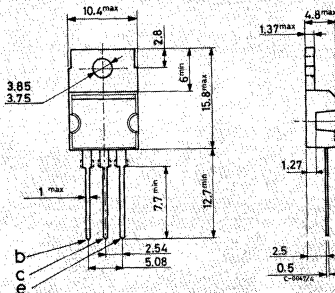

TO-220



THERMAL DATA

$R_{th\ j-case}$	Thermal resistance junction-case	max	2.08	°C/W
$R_{th\ j-amb}$	Thermal resistance junction-ambient	max	70	°C/W

ELECTRICAL CHARACTERISTICS ($T_{case} = 25^{\circ}C$ unless otherwise specified)

Parameter	Test conditions	Min.	Typ.	Max.	Unit
I_{CEV}	Collector cutoff current ($V_{BE} = -1.5V$) for BU406D and BU408D $V_{CE} = 400V$ for BU407D $V_{CE} = 330V$			15	mA
				15	mA
I_{EBO}	Emitter cutoff current ($I_C = 0$) $V_{EB} = 6V$			400	mA
$V_{CE(sat)^*}$	Collector-emitter saturation voltage for BU406D and BU407D $I_C = 5A$ $I_B = 0.65A$ for BU408D $I_C = 6A$ $I_B = 1.2A$			1	V
				1	V
$V_{BE(sat)^*}$	Base-emitter saturation voltage for BU406D and BU407D $I_C = 5A$ $I_B = 0.65A$ for BU408D $I_C = 6A$ $I_B = 1.2A$			1.3	V
				1.5	V
f_T	Transition frequency $I_C = 0.5A$ $V_{CE} = 10V$			10	MHz
t_{off}	Turn-off time for BU406D and BU407D $I_C = 5A$ $I_{B\ end} = 0.65A$ for BU408D $I_C = 6A$ $I_{B\ end} = 1.2A$			0.75	μs
				0.5	μs
$I_{s/b}$	Second breakdown collector current $V_{CE} = 40V$ $t = 10ms$			4	A
V_F	Diode forward voltage $I_F = 5A$			1.5	V

* Pulsed: pulse duration = 300 μs , duty cycle = 1.5%

DC current gain

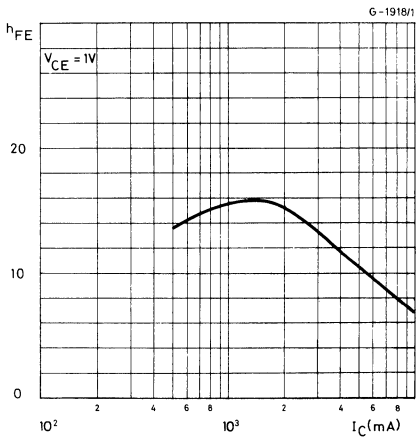

Collector-emitter saturation voltage

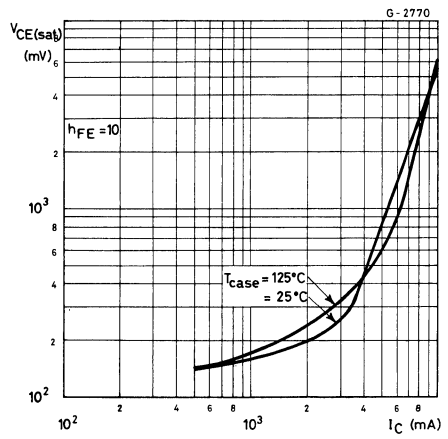

Base-emitter saturation voltage

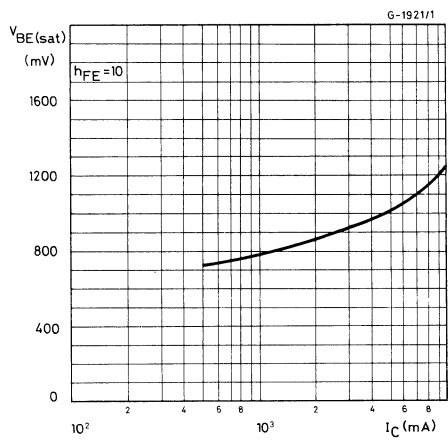

Forward voltage

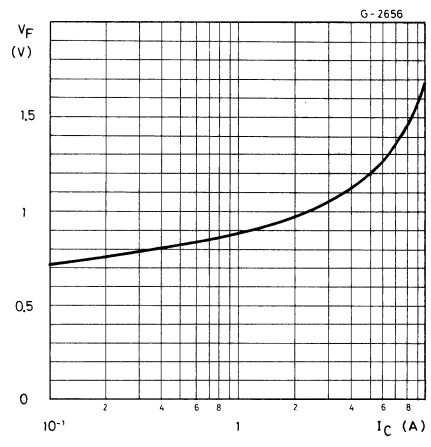



**BU406D
BU407D
BU408D**

SWITCHING TIMES

Test circuit (fall, storage and turn-off time)

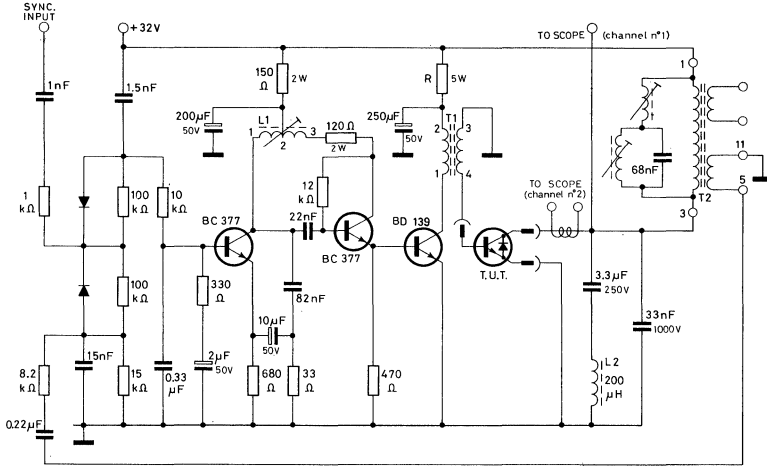

- L1 Horizontal hold coil: Pins 1-2=75 turns \varnothing 0.2mm; R=1.5 Ω ; L min = 0.62 mH
 Pins 2-3=293 turns \varnothing 0.2mm; R=4.8 Ω ; L max = 4.1 mH Core = siferrite B62120 25x4x2
- L2 Horizontal yoke = 200 μ H
- T1 Driver transformer: Pins 1-2=125 turns \varnothing 0.2mm; Pins 3-4=25 turns \varnothing 0.4mm; Gap = 0.12mm; Core = 3E3 double E 19x15x5
- T2 EHT transformer manufacturer ARCO type 243.065/035
 R = 270 Ω for BU406D and BU407D
 R = 180 Ω for BU408D

Waveforms

Fall and storage time

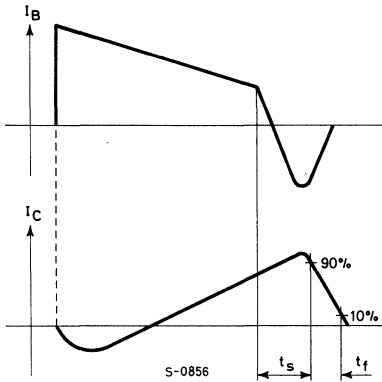

Turn-off time

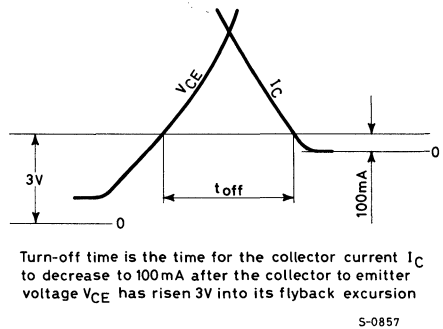

Turn-off time is the time for the collector current I_C to decrease to 100mA after the collector to emitter voltage V_{CE} has risen 3V into its flyback excursion



APPLICATION INFORMATION

Two examples are given of the BU 406D and BU 407D in conventional MTV horizontal deflection circuits.

BU 406D - application circuit for 17'' to 24'' - 110° - 28 mm neck picture tubes

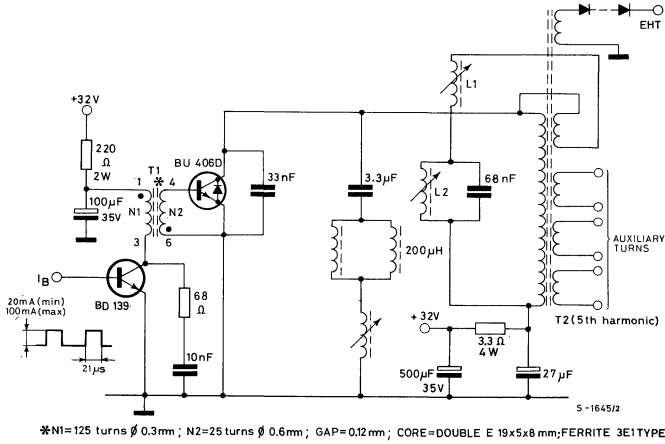

BU 407D - application circuit for 12'' to 17'' - 110° - 20 mm neck picture tubes
(driver supply voltage = 10.8 V)

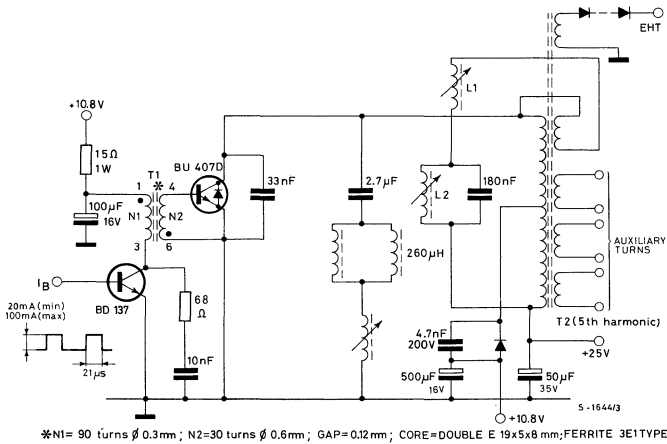



BU406D
BU407D
BU408D

APPLICATION INFORMATION (continued)

BU 407D - application circuit for 12'' to 17'' - 110° - 20 mm neck picture tubes
(driver supply voltage = 25 V)

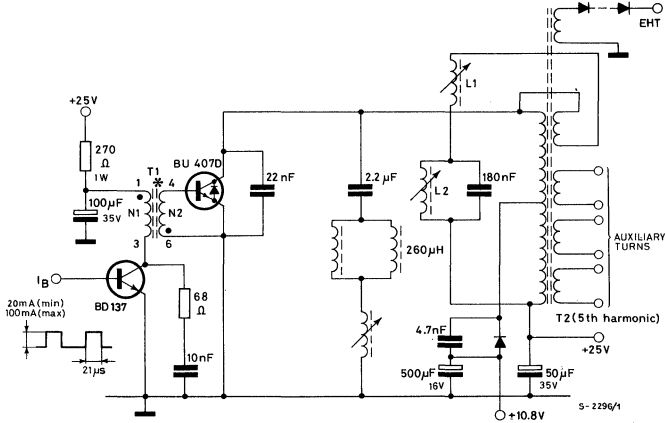



EPITAXIAL PLANAR NPN

HORIZONTAL TV DEFLECTORS

The BU 407 and BU 407H are silicon epitaxial planar NPN transistors in Jedec TO-220 plastic package. They are fast switching, high voltage devices for use in horizontal deflection output stages of medium and small screens MTV receivers with 110° CRT.

ABSOLUTE MAXIMUM RATINGS

V_{CBO}	Collector-base voltage ($I_E = 0$)	330	V
V_{CEV}	Collector-emitter voltage ($V_{BE} = -1.5V$)	330	V
V_{CEO}	Collector-emitter voltage ($I_B = 0$)	150	V
V_{EBO}	Emitter-base voltage ($I_C = 0$)	6	V
I_C	Collector current	7	A
I_{CM}	Collector peak current (repetitive)	10	A
I_{CM}	Collector peak current ($t = 10$ ms)	15	A
I_B	Base current	4	A
P_{tot}	Total power dissipation at $T_{case} \leq 25$ °C	60	W
T_{stg}	Storage temperature	-65 to 150	°C
T_j	Junction temperature	150	°C

INTERNAL SCHEMATIC DIAGRAM

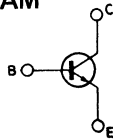

MECHANICAL DATA

Dimensions in mm

Collector connected to tab.

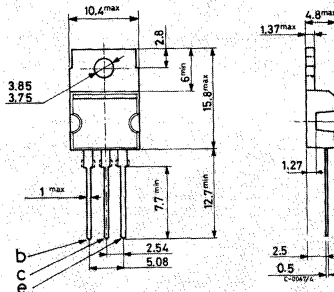

TO-220



BU407
BU407H

THERMAL DATA

$R_{th\ j-case}$	Thermal resistance junction-case	max	2.08	°C/W
$R_{th\ j-amb}$	Thermal resistance junction-ambient	max	70	°C/W

ELECTRICAL CHARACTERISTICS ($T_{case} = 25\text{ °C}$ unless otherwise specified)

Parameter	Test conditions	Min.	Typ.	Max.	Unit
I_{CES}	Collector cutoff current ($V_{BE} = 0$)	$V_{CE} = 330V$ $V_{CE} = 200V$ $V_{CE} = 200V$		5 100 1	mA μA mA
I_{EBO}	Emitter cutoff current ($I_C = 0$)	$V_{EB} = 6\text{ V}$		1	mA
$V_{CE(sat)}^*$	Collector-emitter saturation voltage	for BU407 $I_C = 5\text{ A}$ for BU407H $I_C = 5\text{ A}$	$I_B = 0.5A$ $I_B = 0.8A$	1 1	V V
$V_{BE(sat)}^*$	Base-emitter saturation voltage	for BU407 $I_C = 5\text{ A}$ for BU407H $I_C = 5\text{ A}$	$I_B = 0.5A$ $I_B = 0.8A$	1.2 1.2	V V
f_T	Transition frequency	$I_C = 0.5\text{ A}$	$V_{CE} = 10\text{ V}$	10	MHz
t_{off}^{**}	Turn-off time	for BU407 $I_C = 5\text{ A}$ for BU407H $I_C = 5\text{ A}$	$I_{B\ end} = 0.5A$ $I_{B\ end} = 0.8A$	0.75 0.4	μs μs
$I_{s/b}$	Second breakdown collector current	$V_{CE} = 40\text{ V}$	$t = 10ms$	4	A

* Pulsed: pulse duration = 300 μs , duty cycle = 1.5%

** See test circuit

DC current gain

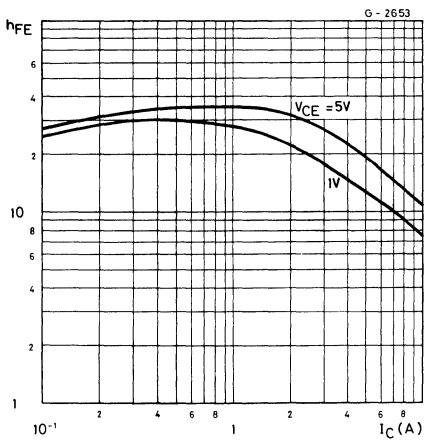

Collector-emitter saturation voltage

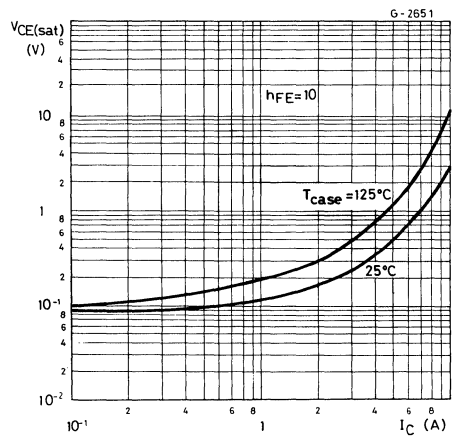

Base-emitter saturation voltage

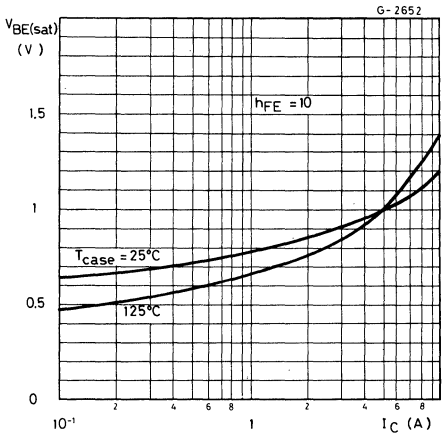

Collector cutoff current

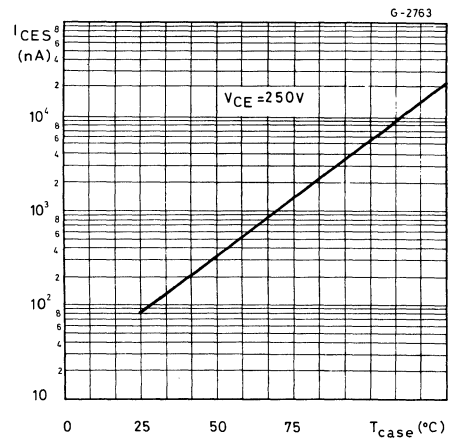

Storage time

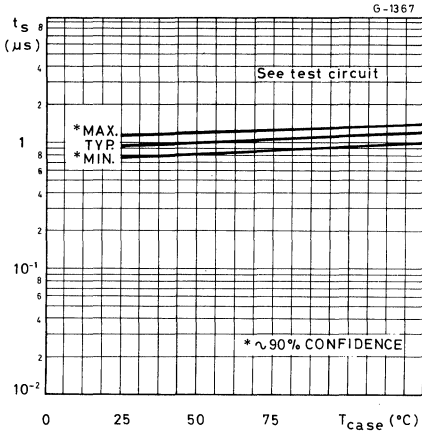

Fall time

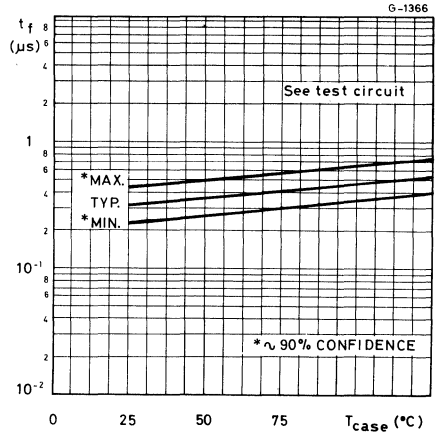

Turn-off time

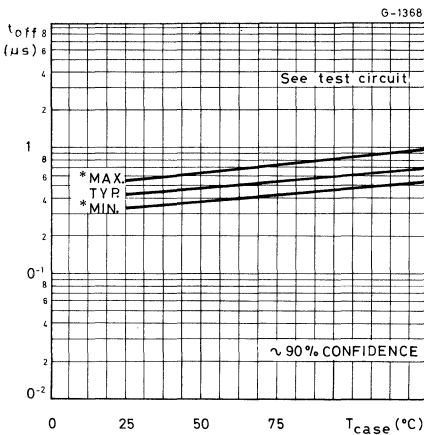



BU407
BU407H

SWITCHING TIMES

Test circuit (fall, storage and turn-off time)

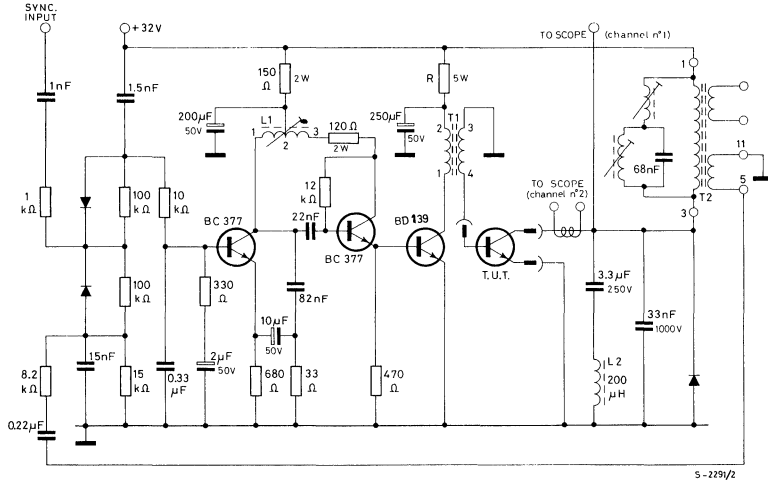

- L1 Horizontal hold coil: Pins 1-2=75 turns ϕ 0.2 mm; $R=1.5 \Omega$; $L_{min}=0.62$ mH
Pins 2-3=293 turns ϕ 0.2 mm; $R=4.8 \Omega$; $L_{max}=4.1$ mH Core=siferrit B 62120 25X4X2
- L2 Horizontal yoke=200 μ H
- T1 Driver transformer: Pins 1-2=125 turns ϕ 0.2 mm;
Pins 3-4=25 turns ϕ 0.4 mm; Gap =0.12 mm; Core=3E3 double E 19X15X5
- T2 EHT transformer manufacturer ARCO type 249.065/035
 $R=330 \Omega$ for BU407
 $R=220 \Omega$ for BU407H

Waveforms

Fall and storage time

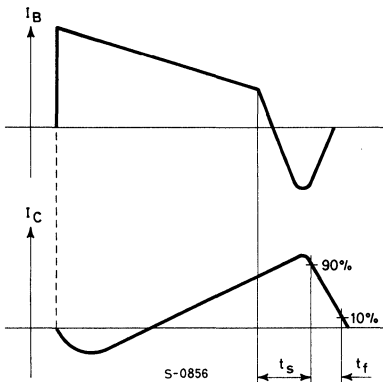

Turn-off time

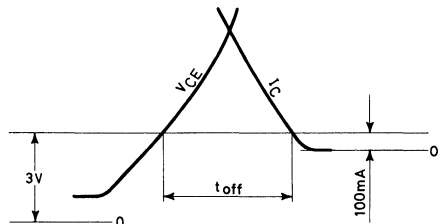

Turn-off time is the time for the collector current I_C to decrease to 100mA after the collector to emitter voltage V_{CE} has risen 3V into its flyback excursion

S-0857



BU407 BU407H

APPLICATION INFORMATION

Two examples are given of the BU407 in conventional MTV horizontal deflection circuits

BU 407 - application circuit for 12'' to 17'' - 110° - 20 mm neck picture tubes
(driver supply voltage = 10.8V)

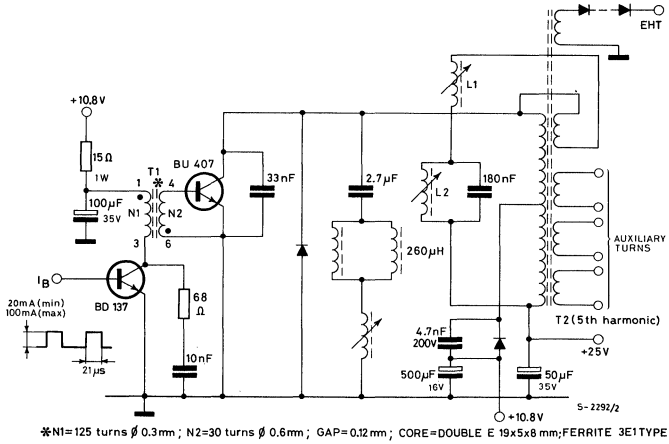

BU 407 - application circuit for 12'' to 17'' - 110° - 20 mm neck picture tubes
(driver supply voltage = 25 V)

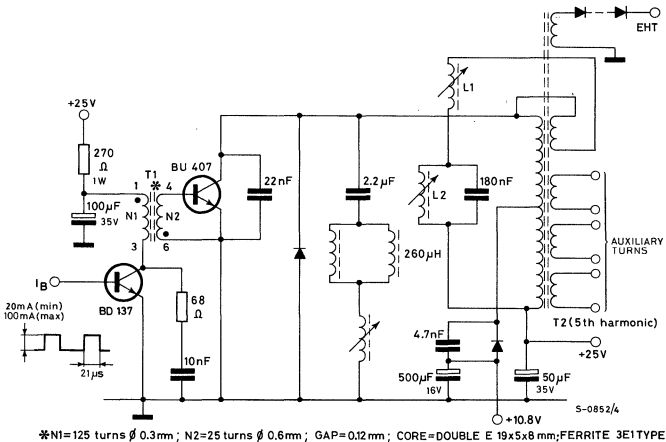



BU426
BU426A

MULTIEPITAXIAL MESA NPN

HIGH VOLTAGE POWER SWITCH

The BU426 and BU426A are silicon multiepitaxial mesa NPN transistors in SOT-93 plastic package, particularly intended for switch-mode CTV supply systems.

ABSOLUTE MAXIMUM RATINGS

	BU426	BU426A
V_{CES}	800 V	900V
V_{CEO}	375V	400V
V_{EBO}		10V
I_C		6A
I_{CM}		8A
I_B		3A
P_{tot}		113W
T_{stg}		-65°C to 150°C
T_j		150°C

INTERNAL SCHEMATIC DIAGRAM

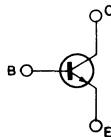

MECHANICAL DATA

Dimensions in mm

Collector connected to tab.

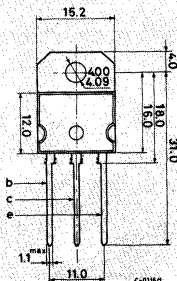

(sim. to TO-218) SOT-93



BU426
BU426A

THERMAL DATA

$R_{th\ j-case}$	Thermal resistance junction-case	max.	1.1	°C/W
------------------	----------------------------------	------	-----	------

ELECTRICAL CHARACTERISTICS ($T_{case} = 25^{\circ}C$ unless otherwise specified)

Parameter	Test conditions	Min.	Typ.	Max.	Unit
I_{CES} Collector cutoff current ($V_{BE} = 0$)	for BU426 $V_{CE} = 800V$			1	mA
	for BU426A $V_{CE} = 900V$			1	mA
	$T_{case} = 125^{\circ}C$				
	for BU426 $V_{CE} = 800V$			2	mA
	for BU426A $V_{CE} = 900V$			2	mA
I_{EBO} Emitter cutoff current ($I_C = 0$)	$V_{EB} = 10V$			10	mA
$V_{CEO(sus)}$ * Collector-emitter sustaining voltage ($I_B = 0$)	for BU426 $I_{C_V} = 100mA$	375			V
	for BU426A $I_C = 100mA$	400			V
$V_{CE(sat)}$ * Collector-emitter saturation voltage	$I_C = 2.5A$ $I_B = 0.5A$			1.5	V
	$I_C = 4A$ $I_B = 1.25A$			3	V
$V_{BE(sat)}$ * Base-emitter saturation voltage	$I_C = 2.5A$ $I_B = 0.5A$			1.4	V
	$I_C = 4A$ $I_B = 1.25A$			1.6	V
h_{FE} * DC current gain	$I_C = 0.6A$ $V_{CE} = 5V$		30	60	V
t_{on} Turn-on time	$I_C = 2.5A$ $I_{B1} = 0.5A$ $V_{CC} = 250V$		0.25	0.5	μs

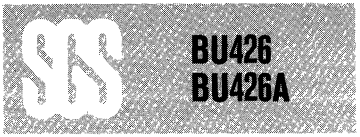

ELECTRICAL CHARACTERISTIC (Continued)

Parameter	Test conditions	Min.	Typ.	Max.	Unit
t_s Storage time	$I_C = 2.5A$ $I_{B1} = 0.5A$	2.5	3.5		μs
t_f Fall time	$I_{B2} = -1A$ $V_{CC} = 250V$	0.2	0.5		μs
t_f Fall time	$I_C = 2.5A$ $I_{B1} = 0.5A$ $I_{B2} = -1A$ $V_{CC} = 250V$ $T_{case} = 100^\circ C$			0.75	μs

* Pulsed: pulse duration = 300 μs duty cycle = 1.5%.

Safe operating areas

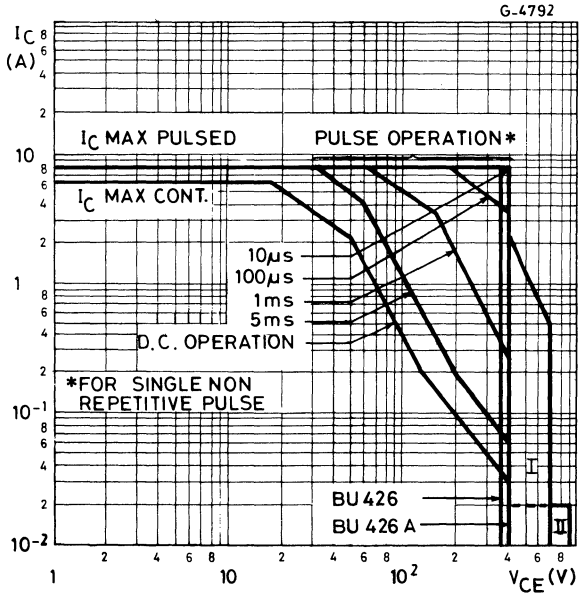

I = Area of permissible operation driving turn-on provided $R_{BE} = 100\Omega$ and $t_p \leq 0.6 \mu s$.
 II = Area of permissible operation with $V_{BE} \leq 0$; $t_p \leq 2 \mu s$.



BU801

EPITAXIAL PLANAR NPN

HIGH VOLTAGE FAST DARLINGTON

The BU801 is a silicon epitaxial planar NPN Darlington transistor with integrated base-emitter speed-up diode, mounted in Jedec TO-126 plastic package. It is particularly suitable as output stage in medium power and driver stage in high power, fast switching applications.

ABSOLUTE MAXIMUM RATINGS

V_{CB0}	Collector-base voltage ($I_E = 0$)	600	V
V_{CEO}	Collector-emitter voltage ($I_B = 0$)	400	V
V_{EBO}	Emitter-base voltage ($I_C = 0$)	7	V
I_C, I_E	Collector and emitter currents	3	A
I_B	Base current	1	A
P_{tot}	Total power dissipation at $T_{case} \leq 25^\circ C$	40	W
T_{stg}	Storage temperature	-65 to 150	$^\circ C$
T_j	Junction temperature	150	$^\circ C$

INTERNAL SCHEMATIC DIAGRAM

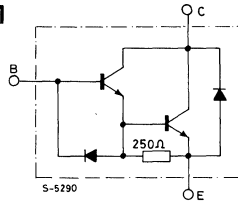

MECHANICAL DATA

Dimensions in mm

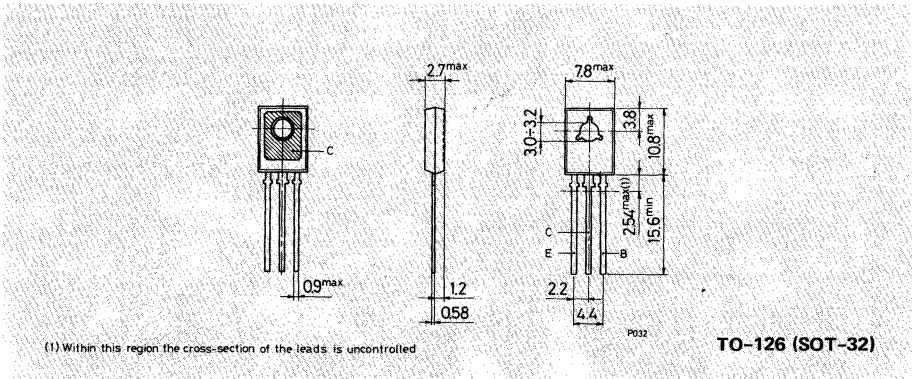



THERMAL DATA

$R_{th\ j-case}$ Thermal resistance junction-case	max	3.12	°C/W
---	-----	------	------

ELECTRICAL CHARACTERISTICS ($T_{case} = 25^{\circ}C$ unless otherwise specified)

Parameter	Test conditions	Min.	Typ.	Max.	Unit
I_{CES} Collector-cutoff current ($V_{BE} = 0$)	$V_{CE} = 600V$			200	μA
I_{CEO} Collector-cutoff current ($I_B = 0$)	$V_{CE} = 400V$			1	mA
I_{EBO}^* Emitter cutoff current ($I_C = 0$)	$V_{EB} = 7V$			100	mA
$V_{CEO(sus)}^*$ Collector-emitter sustaining voltage	$I_C = 10\text{ mA}$	400			V
$V_{CE(sat)}^*$ Collector-emitter saturation voltage	$I_C = 200\text{ mA}$		1.0	1.5	V
	$I_C = 1A$		1.2	2.0	V
	$I_C = 2A$		1.8	3.0	V
$V_{BE(sat)}^*$ Base-emitter saturation voltage	$I_C = 200\text{ mA}$			2	V
	$I_C = 1A$			2.5	V
	$I_C = 2A$			3	V
β_{FE}^* DC current gain	$I_C = 200\text{ mA}$ $V_{CE} = 3V$	100			—
V_F^* Diode forward voltage	$I_F = 1A$			4	V

RESISTIVE SWITCHING TIMES

t_{on} Turn-on time	$V_{CC} = 250V$ $I_C = 200\text{ mA}$ $I_{B1} = 2\text{ mA}$ $V_{BEoff} = -5V$	0.17	0.8	μs
t_s Storage time		0.37	1	μs
t_f Fall time		0.13	0.5	μs

ELECTRICAL CHARACTERISTICS (continued)

Parameter		Test conditions	Min.	Typ.	Max.	Unit
t_{on}	Turn-on time	$V_{CC} = 250V$ $I_C = 1A$ $I_{B1} = 20 mA$ $V_{BEoff} = -5V$	0.18	0.8		μs
t_s	Storage time		0.38	1		μs
t_f	Fall time		0.09	0.5		μs

INDUCTIVE SWITCHING TIMES

t_s	Storage time	$V_{Clamp} = 250V$ $I_C = 200 mA$ $I_{B1} = 2 mA$ $V_{BEoff} = -5V$	0.35	1	μs
t_f	Fall time		0.09	0.4	μs
t_s	Storage time	$V_{Clamp} = 250V$ $I_C = 1A$ $I_{B1} = 20 mA$ $V_{BEoff} = -5V$	0.5	1	μs
t_f	Fall time		0.06	0.4	μs

* Pulsed: Pulse duration = 300 μs , duty cycle = 1.5%

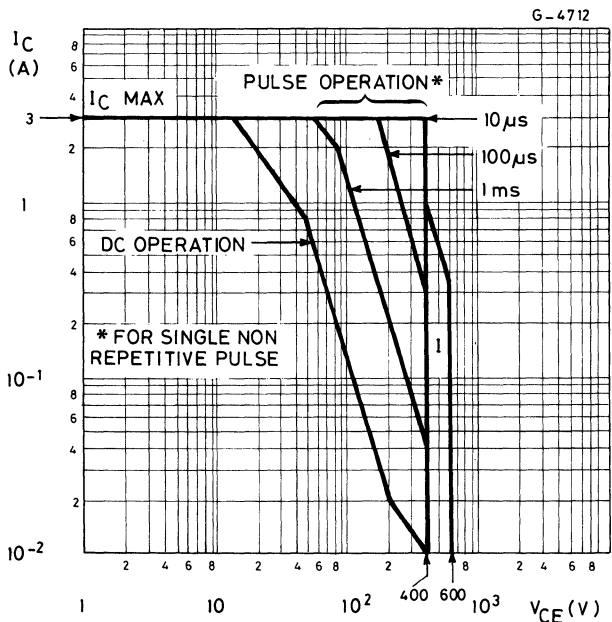
Safe operating areas

I = Area of permissible operation during turn-on with $t_p \leq 1 \mu s$.

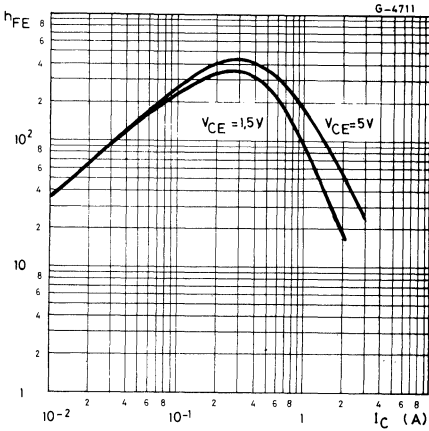
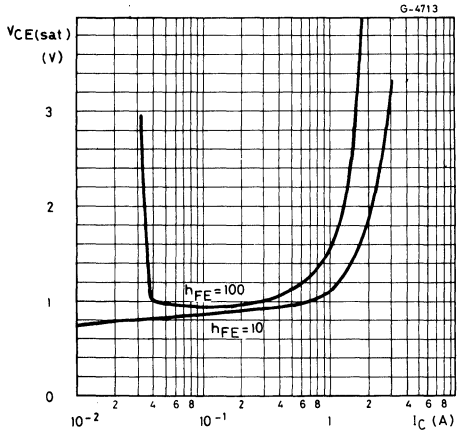
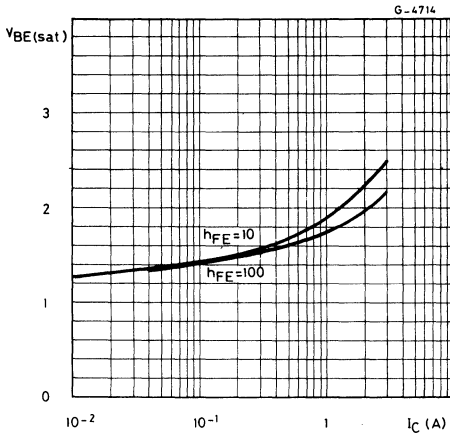
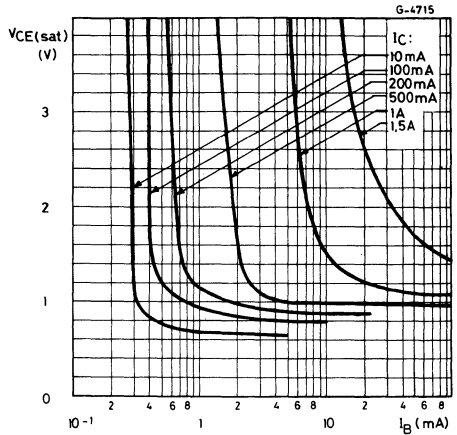
DC current gain

Collector-emitter saturation voltage

Base-emitter saturation voltage

Collector-emitter saturation voltage

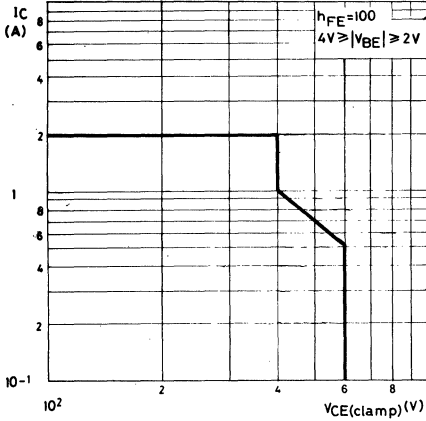

BU801

Clamped reverse bias safe operating area

G-4716



Saturated switching characteristics (resistive load)

G-4717

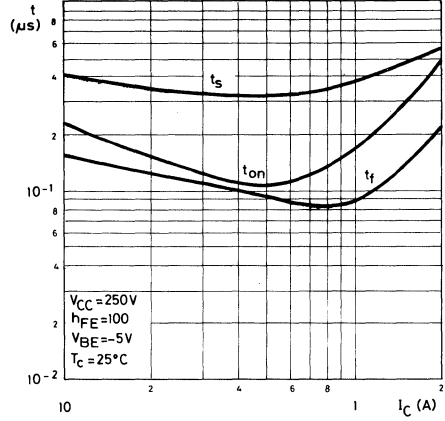

Saturated switching characteristics (inductive load)

G-4718

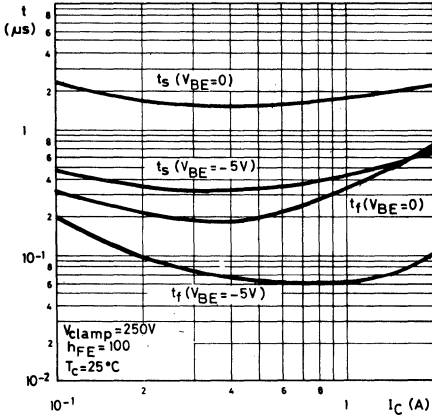

Derating curves

G-4719

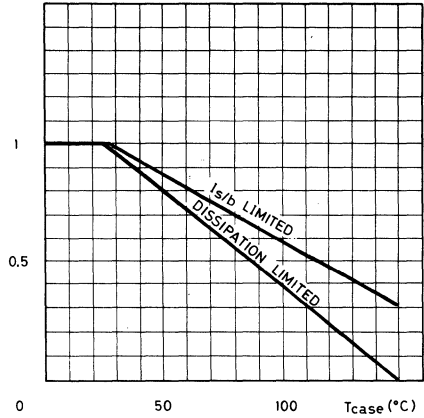

EPITAXIAL PLANAR NPN

FAST SWITCHING DARLINGTON TRANSISTORS

The BU 806 and BU 807 are silicon epitaxial planar NPN power Darlington transistors with integrated base-emitter speed-up diode, mounted in Jedec TO-220 plastic package. They are high voltage, high current devices for fast switching applications. In particular they can be used in horizontal output stages of 110° CRT video displays. The BU 806 is primarily intended for large screen, while the BU 807 is for medium and small screens.

ABSOLUTE MAXIMUM RATINGS

		BU 806	BU 807
V_{CBO}	Collector-base voltage ($I_E = 0$)	400V	330V
V_{CEV}	Collector-emitter voltage ($V_{BE} = -6V$)	400V	330V
V_{CEO}	Collector-emitter voltage ($I_B = 0$)	200V	150V
V_{EBO}	Emitter-base voltage ($I_C = 0$)		6V
I_C	Collector current		8A
I_{CM}	Collector peak current		15A
I_{DM}	Damper diode peak forward current		10A
I_B	Base current		2A
P_{tot}	Total power dissipation at $T_{case} \leq 25^\circ C$		60W
T_{stg}	Storage temperature		-65 to 150°C
T_j	Junction temperature		150°C

INTERNAL SCHEMATIC DIAGRAM

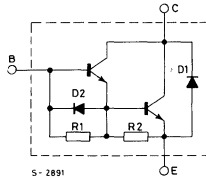

S-2891

Dimensions in mm

MECHANICAL DATA

Collector connected to tab.

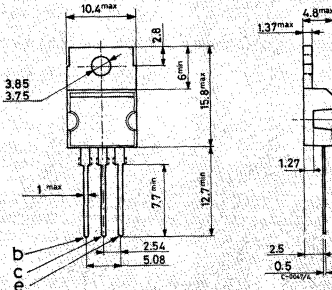

TO-220

THERMAL DATA

$R_{th\ j-case}$	Thermal resistance junction-case	max	2.08	°C/W
$R_{th\ j-amb}$	Thermal resistance junction-ambient	max	70	°C/W

ELECTRICAL CHARACTERISTICS ($T_{case} = 25^{\circ}C$ unless otherwise specified)

Parameter		Test conditions		Min.	Typ.	Max.	Unit	
I_{CES}	Collector cutoff current ($V_{BE}=0$)	for BU807	$V_{CE}=330V$			100	μA	
		for BU806	$V_{CE}=400V$			100	μA	
I_{CEV}	Collector cutoff current ($V_{BE}=-6V$)	for BU807	$V_{CE}=330V$			100	μA	
		for BU806	$V_{CE}=400V$			100	μA	
I_{EBO}	Emitter cutoff current ($I_C=0$)	$V_{EB}=6V$				3	mA	
$V_{CEO(sus)}$	*Collector-emitter sustaining voltage ($I_B=0$)	$I_C = 100mA$ for BU807 for BU806		150		200	V	
$V_{CE(sat)}$	* Collector-emitter saturation voltage	$I_C = 5A$	$I_B = 50mA$			1.5	V	
$V_{BE(sat)}$	* Base-emitter saturation voltage	$I_C = 5A$	$I_B = 50mA$			2.4	V	
V_F	* Damper diode forward voltage	$I_F = 4A$				2	V	
t_{off}^{**}	Turn-off time	$I_C = 5A$	$I_{B1} = 50mA$	0.4		1	μs	
t_{on}	Turn-on time	RESISTIVE LOAD $I_C = 5A$ $I_{B1} = 50mA$ $I_{B2} = -500mA$ $V_{CC} = 100V$				0.35	μs	
t_s	Storage time					0.55		μs
t_f	Fall time					0.2		μs

* Pulsed: pulse duration = 300 μs , duty cycle = 1,5%

** See test circuit

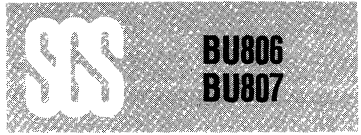

Safe operating areas

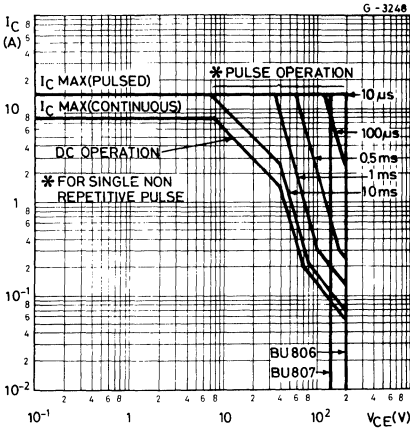

DC current gain

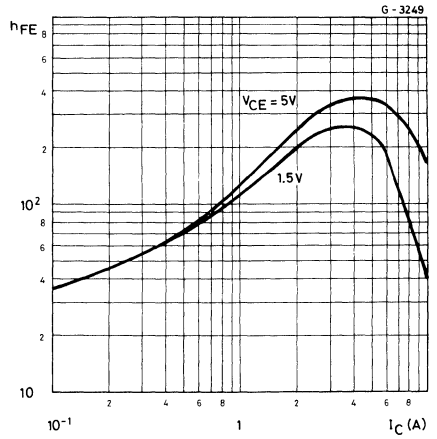

Collector-emitter saturation voltage

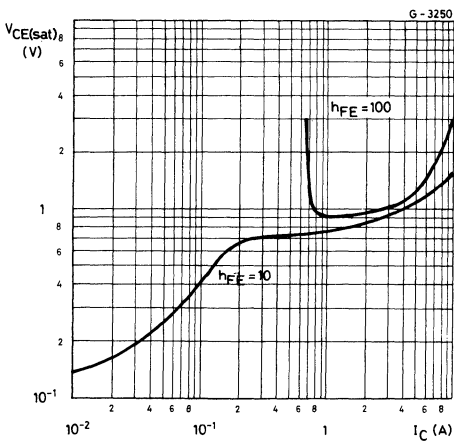

Collector-emitter saturation voltage

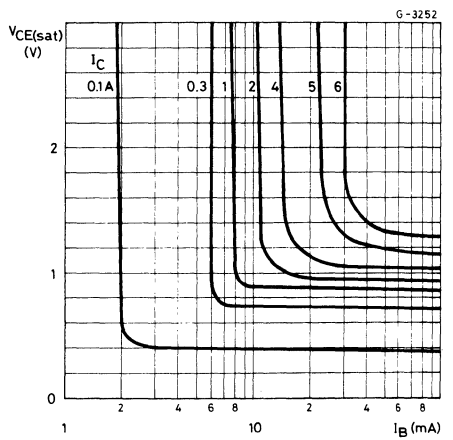

Base-emitter saturation voltage

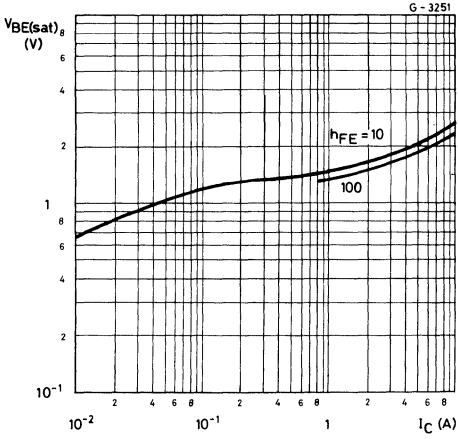

Damper diode

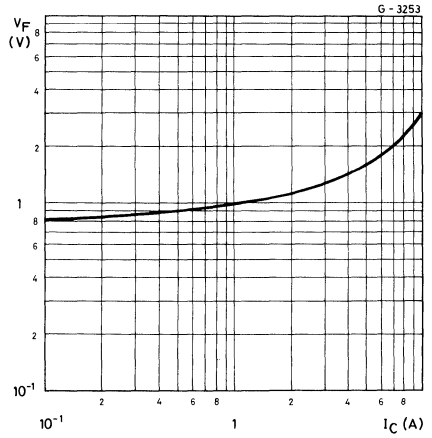

Saturated switching characteristics (resistive load)

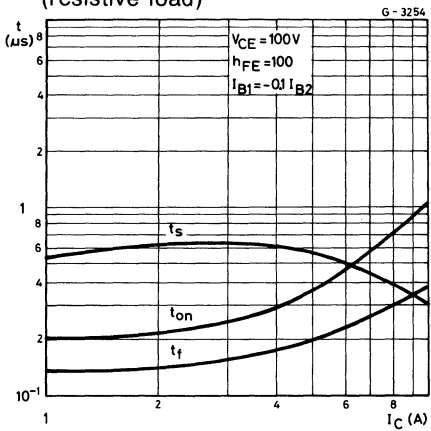

Saturated switching characteristics (inductive load)

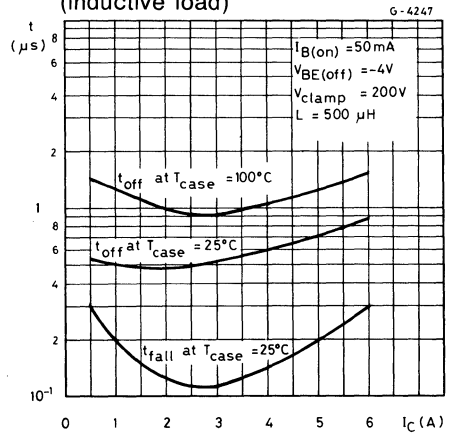

APPLICATION INFORMATION

Horizontal deflection circuit using the darlington BU 806 directly driven by the TDA 1180 (B & W TV set: large screen solution)

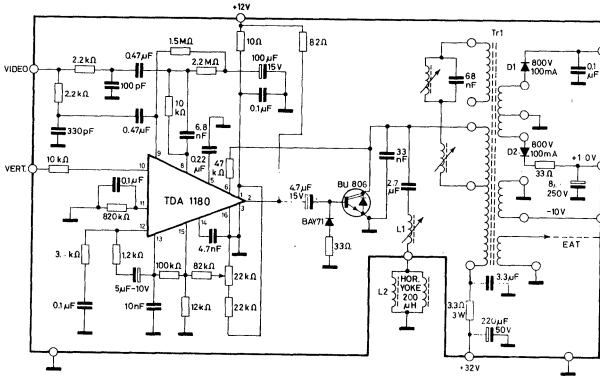

L1 = Linearity inductance RL ±1NE ±0

$L_1 = \text{Linearity inductance } 19 \div 39 \mu\text{H}$

Horizontal deflection circuit using the darlington BU 807 directly driven by the TDA 1180 (B & W TV set: small screen solution).

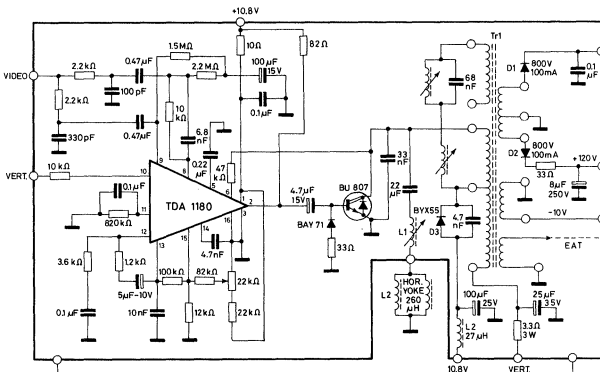

L1 = Linearity inductance RL ±46 INELCO

$L_1 = \text{Linearity inductance } 37 \div 67 \mu\text{H}$



BU810

EPITAXIAL PLANAR NPN

MEDIUM POWER FAST SWITCHING

The BU810 is a silicon epitaxial planar NPN Darlington transistor with integrated base-emitter speed-up diode, mounted in Jedec TO-220 plastic package. It is particularly suitable as output stage in medium power, fast switching applications.

ABSOLUTE MAXIMUM RATINGS

V_{CBO}	Collector-base voltage ($I_E = 0$)	600	V
V_{CEO}	Collector-emitter voltage ($I_B = 0$)	400	V
V_{EBO}	Emitter-base voltage ($I_C = 0$)	5	V
I_C	Collector current	7	A
I_{CM}	Collector peak current	10	A
I_B	Base current	2	A
P_{tot}	Total power dissipation at $T_{case} \leq 25^\circ C$	75	W
T_{stg}	Storage temperature	-65 to 150	$^\circ C$
T_j	Junction temperature	150	$^\circ C$

INTERNAL SCHEMATIC DIAGRAM

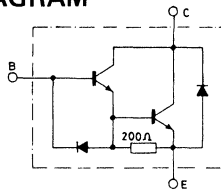

MECHANICAL DATA

Dimensions in mm

Collector connected to tab.

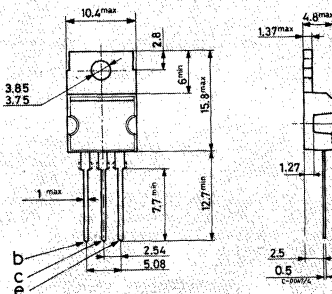

TO-220

**BU810****THERMAL DATA**

$R_{th\ j-case}$ Thermal resistance junction-case	max. 1.66 °C/W
---	----------------

ELECTRICAL CHARACTERISTICS ($T_{case} = 25^{\circ}C$ unless otherwise specified)

Parameter	Test conditions	Min.	Typ.	Max.	Unit
I_{CES} Collector cutoff current ($V_{BE} = 0$)	$V_{CE} = 600V$			200	μA
I_{CEO} Collector cutoff current ($I_B = 0$)	$V_{CE} = 400V$			1	mA
I_{EBO}^* Emitter cutoff current ($I_C = 0$)	$V_{EB} = 5V$			150	mA
$V_{CEO(sus)}^*$ Collector-emitter sustaining voltage	$I_C = 100mA$	400			V
$V_{CE(sat)}^*$ Collector-emitter saturation voltage	$I_C = 2A$ $I_B = 20mA$ $I_C = 4A$ $I_B = 200mA$ $I_C = 7A$ $I_B = 0.7A$			2 2.5 3	V V V
$V_{BE(sat)}^*$ Base-emitter saturation voltage	$I_C = 2A$ $I_B = 20mA$ $I_C = 4A$ $I_B = 200mA$			2.2 3	V V
V_F^* Diode forward voltage	$I_F = 7A$			3	V

RESISTIVE SWITCHING TIMES

t_{on} Turn-on time	$V_{CC} = 250V$ $I_C = 2A$ $I_{B1} = 20mA$ $V_{BE(off)} = -5V$	0.6	μs
t_s Storage time		1.5	μs
t_f Fall time		0.5	μs

INDUCTIVE SWITCHING TIMES

t_s Storage time	$V_{Clamp} = 250V$ $I_C = 7A$ $I_{B1} = 0.7A$ $V_{BE(off)} = -5V$	1.5	μs
t_f Fall time		0.4	μs
t_s Storage time		1.5	μs
t_f Fall time		0.7	μs

* Pulsed: pulse duration = 300 μs , duty cycle = 1.5%.

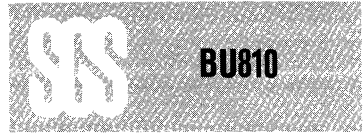

Safe operating areas

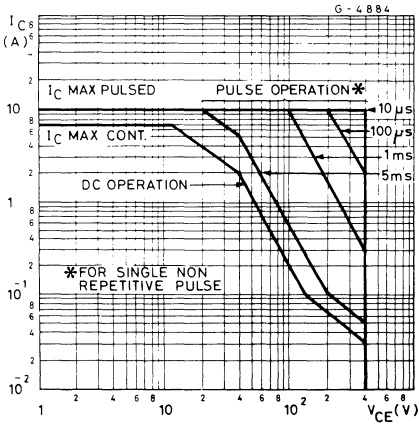

DC current gain

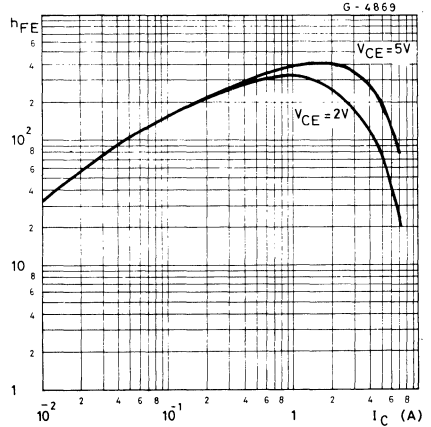

Collector-emitter saturation voltage

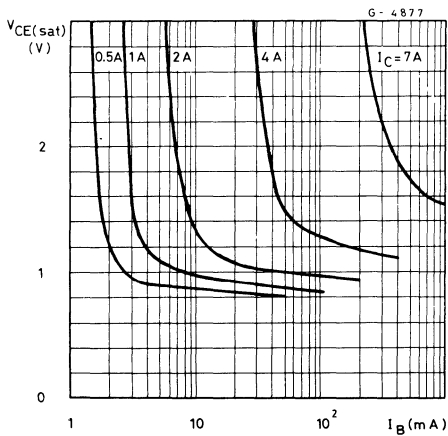

Collector-emitter saturation voltage

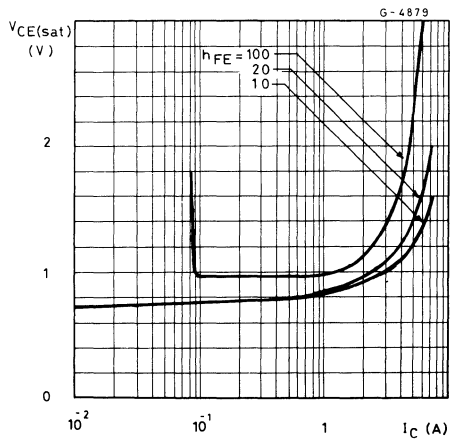

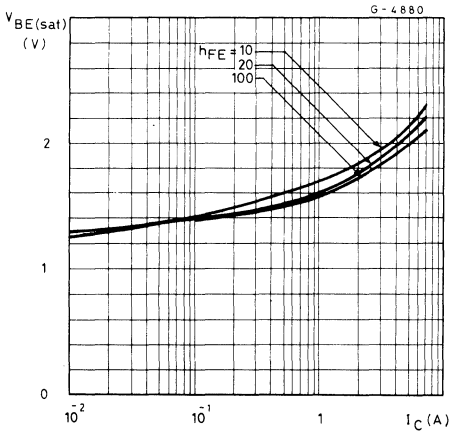
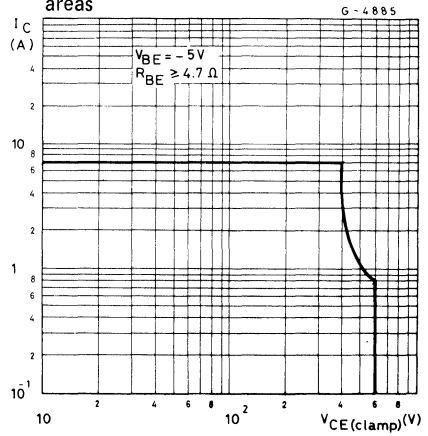
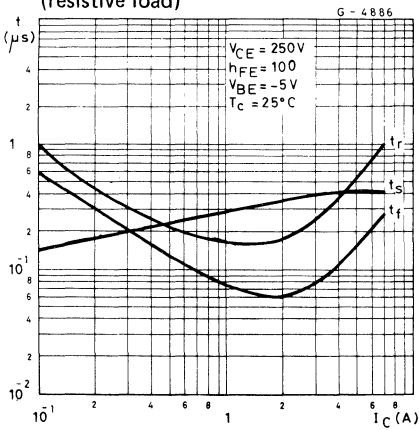
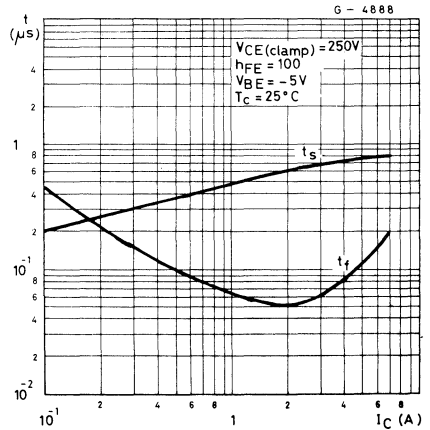
Base-emitter saturation voltage

Clamped reverse bias safe operating areas

Saturated switching characteristics (resistive load)

Saturated switching characteristics



MULTIEPITAXIAL PLANAR NPN

HIGH VOLTAGE POWER DARLINGTON

The BU 910, BU 911 and BU 912 are high voltage, silicon NPN transistors in monolithic Darlington configuration in Jedec TO-220 plastic package, designed for applications such as electronic ignition, DC and AC motor controls, solenoid drivers, etc.

ABSOLUTE MAXIMUM RATINGS

		BU 910	BU 911	BU 912
V_{CES}	Collector-emitter voltage ($V_{BE} = 0$)	400V	450V	500V
V_{CEO}	Collector-emitter voltage ($I_B = 0$)	350V	400V	450V
V_{EBO}	Emitter-base voltage ($I_C = 0$)		5V	
I_C	Collector current		6A	
I_{CM}	Collector peak current		10A	
I_B	Base current		1A	
P_{tot}	Total power dissipation at $T_{case} \leq 25^\circ C$		60W	
T_{stg}	Storage temperature		-65 to 150°C	
T_j	Junction temperature		150°C	

INTERNAL SCHEMATIC DIAGRAM

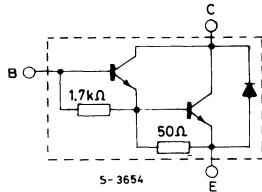

MECHANICAL DATA

Dimensions in mm

Collector connected to tab.

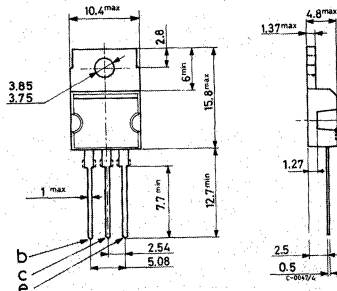

TO-220



BU910
BU911
BU912

THERMAL DATA

$R_{th\ j-case}$	Thermal resistance junction-case	max	2.08 °C/W
------------------	----------------------------------	-----	-----------

ELECTRICAL CHARACTERISTICS ($T_{case} = 25^{\circ}C$ unless otherwise specified)

Parameter	Test conditions	Min.	Typ.	Max.	Unit
I_{CES} Collector cutoff current ($V_{BE} = 0$)	for BU910 $V_{CE} = 400V$			1	mA
	for BU911 $V_{CE} = 450V$			1	mA
	for BU912 $V_{CE} = 500V$			1	mA
	$T_{case} = 125^{\circ}C$				
	for BU910 $V_{CE} = 400V$			5	mA
	for BU911 $V_{CE} = 450V$			5	mA
	for BU912 $V_{CE} = 500V$			5	mA
I_{CEO} Collector cutoff current ($I_B = 0$)	for BU910 $V_{CE} = 350V$			1	mA
	for BU911 $V_{CE} = 400V$			1	mA
	for BU912 $V_{CE} = 450V$			1	mA
I_{EBO} Emitter cutoff current ($I_C = 0$)	$V_{EB} = 5V$			5	mA
$V_{CEO(sus)}$ *Collector-emitter sustaining voltage ($I_B = 0$)	$I_C = 100\text{ mA}$ for BU910 for BU911 for BU912	350			V
		400			V
		450			V
$V_{CE(sat)}$ * Collector-emitter saturation voltage	for BU910 and BU911 $I_C = 2.5A$ $I_B = 50mA$			1.8	V
	for BU912 $I_C = 2A$ $I_B = 50mA$			1.8	V
	All types $I_C = 4A$ $I_B = 200mA$			1.8	V
$V_{BE(sat)}$ * Base-emitter saturation voltage	for BU910 and BU911 $I_C = 2.5A$ $I_B = 50mA$			2.2	V
	for BU912 $I_C = 2A$ $I_B = 50mA$			2.2	V
	All types $I_C = 4A$ $I_B = 200mA$			2.5	V
V_F Diode forward voltage	$I_F = 4A$			2.5	V

*Pulsed: pulse duration = 300 μs , duty cycle = 1.5%

Safe operating areas

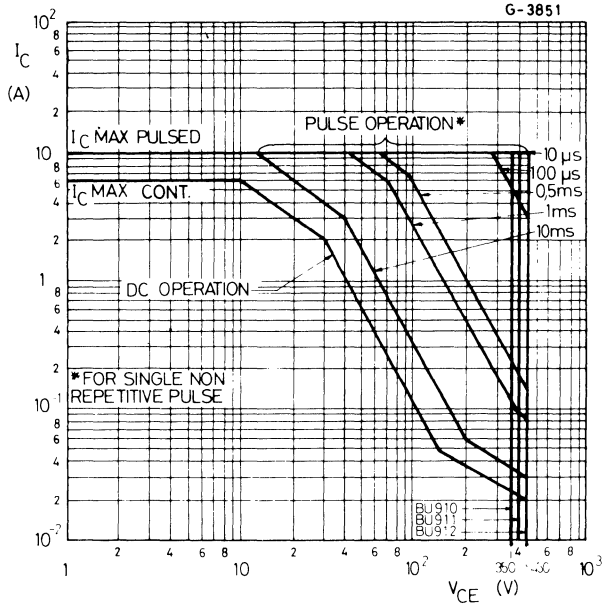

Derating curves

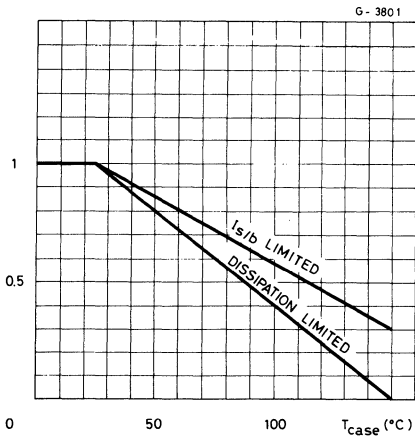

Thermal transient response

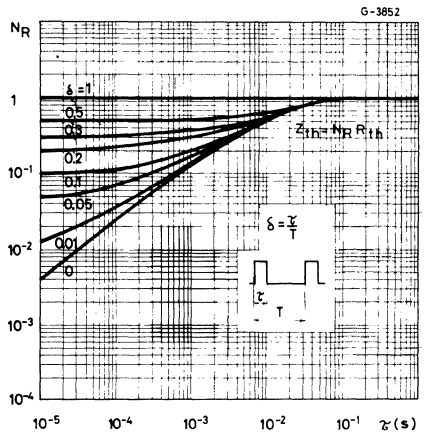

DC current gain

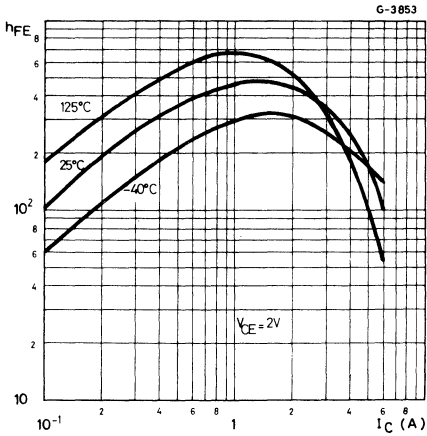

Collector-emitter saturation voltage

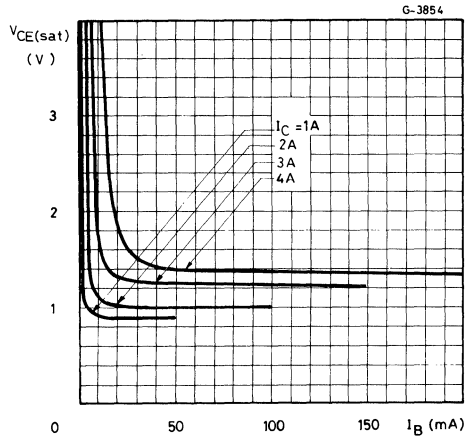

Collector-emitter saturation voltage

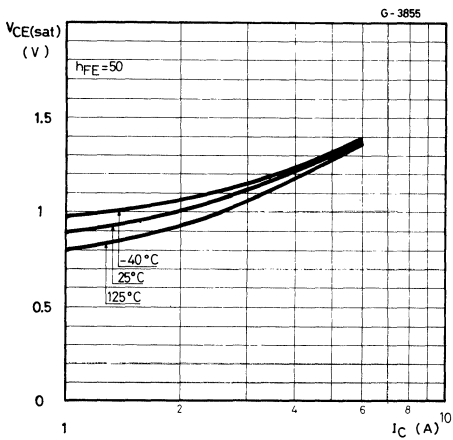

Base-Emitter saturation voltage

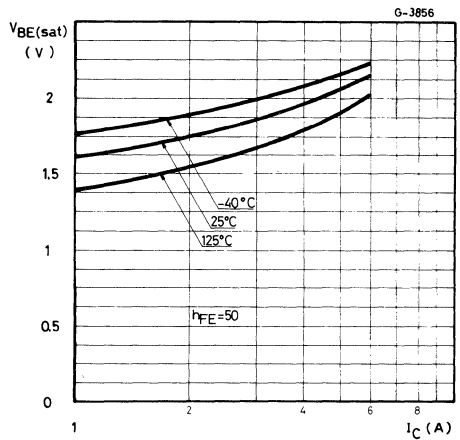

Saturated switching characteristics

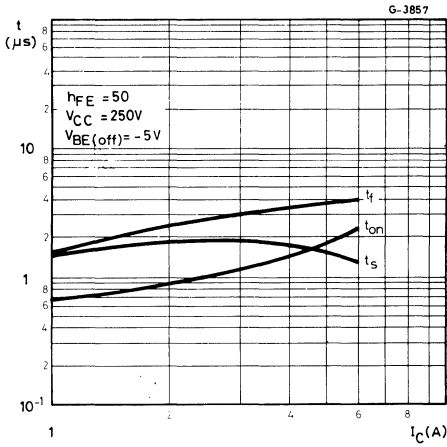

Clamped reverse bias safe operating areas

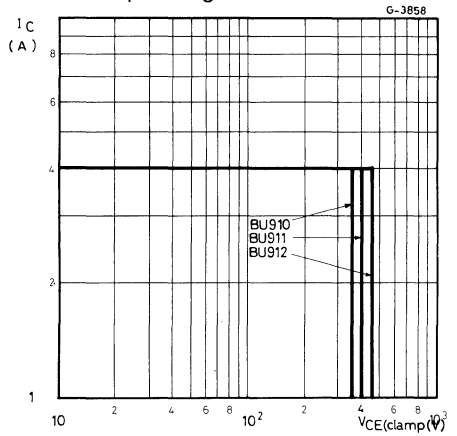

Clamped $E_{s/b}$ test circuit

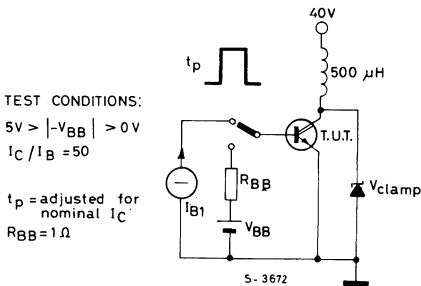



BU920P
BU921P
BU922P

MULTIEPITAXIAL PLANAR NPN

HIGH VOLTAGE POWER DARLINGTON

The BU920P, BU921P, BU922P are high voltage high current silicon NPN transistors in monolithic Darlington configuration in SOT-93 plastic package, specially intended for automotive ignition applications and invert circuits for motor controls.

ABSOLUTE MAXIMUM RATINGS

	BU920P	BU921P	BU922P	
V_{CES}	Collector-emitter voltage ($V_{BE} = 0$)	400V	450V	500V
V_{CEO}	Collector-emitter voltage ($I_B = 0$)	350V	400V	450V
V_{EBO}	Emitter-base voltage ($I_C = 0$)		5V	
I_C	Collector current		10A	
I_{CM}	Collector peak current		15A	
I_B	Base current		5A	
P_{tot}	Total power dissipation at $T_{case} \leq 25^\circ C$		105W	
T_{stg}	Storage temperature		-65 to 150°C	
T_j	Junction temperature		150°C	

INTERNAL SCHEMATIC DIAGRAM

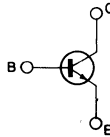

MECHANICAL DATA

Dimensions in mm

Collector connected to tab.

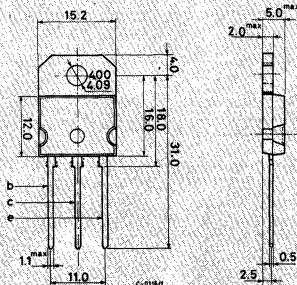

(sim. to TO-218) SOT-93



THERMAL DATA

$R_{th\ j-case}$	Thermal resistance junction-case	max.	1.2	°C/W
------------------	----------------------------------	------	-----	------

ELECTRICAL CHARACTERISTICS ($T_{case} = 25^{\circ}C$ unless otherwise specified)

Parameter	Test conditions	Min.	Typ.	Max.	Unit	
I_{CES} Collector cutoff current ($V_{BE} = 0$)	for BU920P $V_{CE} = 400V$			1	mA	
	for BU921P $V_{CE} = 450V$			1	mA	
	for BU922P $V_{CE} = 500V$			1	mA	
	$T_{case} = 150^{\circ}C$					
	for BU920P $V_{CE} = 400V$			5	mA	
	for BU921P $V_{CE} = 450V$			5	mA	
	for BU922P $V_{CE} = 500V$			5	mA	
I_{CEO} Collector cutoff current ($I_C = 0$)	for BU920P $V_{CE} = 350V$			1	mA	
	for BU921P $V_{CE} = 400V$			1	mA	
	for BU922P $V_{CE} = 450V$			1	mA	
I_{EBO} Emitter cutoff current ($I_C = 0$)	$V_{EB} = 5V$			20	mA	
$V_{CEO(sus)}$ * Collector-emitter sustaining voltage ($I_B = 0$)	$I_C = 100mA$	for BU920P	350		V	
		for BU921P	400		V	
		for BU922P	450		V	

ELECTRICAL CHARACTERISTICS (continued)

Parameter	Test conditions	Min.	Typ.	Max.	Unit
$V_{CE(sat)}$ * Collector-emitter saturation voltage	$I_C = 5A$ $I_B = 50mA$			1.8	V
	$I_C = 7A$ $I_B = 140mA$			1.8	V
$V_{BE(sat)}$ * Base-emitter saturation voltage	$I_C = 5A$ $I_B = 50mA$			2.2	V
	$I_C = 7A$ $I_B = 140mA$			2.5	V
V_F * Diode forward voltage	$I_F = 7A$			2.5	V

* Pulsed: pulse duration = 300 μs , duty cycle = 1.5%.

Safe operating areas

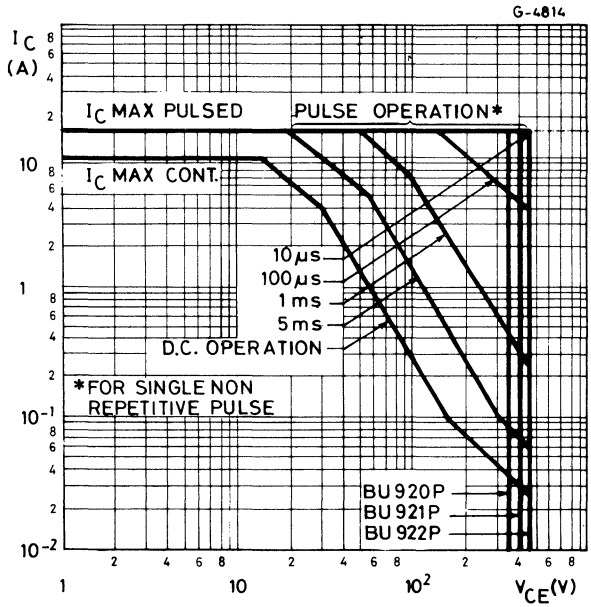

MULTIEPITAXIAL PLANAR NPN

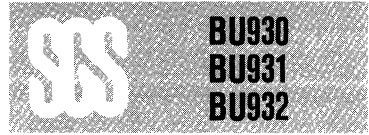

HIGH VOLTAGE POWER DARLINGTON

The BU 930, BU 931 and BU 932 are high voltage, high current silicon NPN transistor in monolithic Darlington configuration in Jedec TO-3 metal case specially intended for automotive ignition applications and inverter circuits for motor controls.

ABSOLUTE MAXIMUM RATINGS

		BU930	BU931	BU932
V_{CES}	Collector-emitter voltage ($V_{BE} = 0$)	400V	450V	500V
V_{CEO}	Collector-emitter voltage ($I_B = 0$)	350V	400V	450V
V_{EBO}	Emitter-base voltage ($I_C = 0$)		5V	
I_C	Collector current		15A	
I_{CM}	Collector peak current		20A	
I_B	Base current		1A	
P_{tot}	Total power dissipation at $T_{case} \leq 25^\circ C$		150W	
T_{stg}	Storage temperature		-65 to 175°C	
T_j	Junction temperature		175°C	

INTERNAL SCHEMATIC DIAGRAM

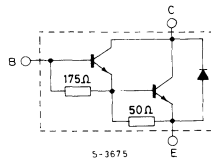

MECHANICAL DATA

Dimensions in mm

Collector connected to case

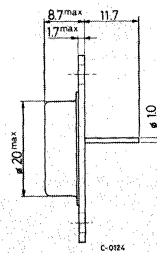
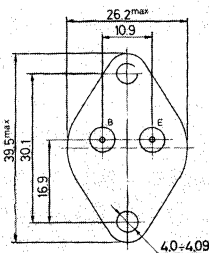

TO-3



BU930
BU931
BU932

THERMAL DATA

$R_{th\ j-case}$	Thermal resistance junction-case	max	1	°C/W
------------------	----------------------------------	-----	---	------

ELECTRICAL CHARACTERISTICS ($T_{case}=25^{\circ}C$ unless otherwise specified)

Parameter	Test conditions	Min.	Typ.	Max.	Unit
I_{CES} Collector cutoff current ($V_{BE}=0$)	for BU930 $V_{CE}=400V$			1	mA
	for BU931 $V_{CE}=450V$			1	mA
	for BU932 $V_{CE}=500V$			1	mA
	$T_{case}=150^{\circ}C$				
	for BU930 $V_{CE}=400V$			5	mA
	for BU931 $V_{CE}=450V$			5	mA
	for BU932 $V_{CE}=500V$			5	mA
I_{CEO} Collector cutoff current ($I_B=0$)	for BU930 $V_{CE}=350V$			1	mA
	for BU931 $V_{CE}=400V$			1	mA
	for BU932 $V_{CE}=450V$			1	mA
I_{EBO} Emitter cutoff current ($I_C=0$)	$V_{EB}=5V$			50	mA
$V_{CEO(sus)}$ *Collector-emitter sustaining voltage	$I_C=100mA$				
	for BU930	350			V
	for BU931	400			V
	for BU932	450			V
$V_{CE(sat)}$ * Collector-emitter saturation voltage	for BU930 and BU931				
	$I_C=7A$ $I_B=70mA$			1.6	V
	$I_C=8A$ $I_B=100mA$			1.8	V
	$I_C=10A$ $I_B=250mA$			1.8	V
	for BU932				
	$I_C=8A$ $I_B=150mA$			1.8	V
$V_{BE(sat)}$ * Base-emitter saturation voltage	for BU930 and BU931				
	$I_C=8A$ $I_B=100mA$			2.2	V
	$I_C=10A$ $I_B=250mA$			2.5	V
	for BU932				
	$I_C=8A$ $I_B=150mA$			2.2	V



ELECTRICAL CHARACTERISTICS (continued)

Parameter	Test conditions	Min.	Typ.	Max.	Unit
V_F^* Diode forward voltage	$I_F = 10A$		2.5		V
Functional test (see test circuit fig. 2 and 3)	for BU930 $V_{CE}=350V$ $L = 7mH$	8			A
	for BU931 and BU932 $V_{CE}=400V$ $L = 7mH$	8			A

* Pulsed: pulse duration = 300 μs , duty cycle = 1.5%

Safe operating areas

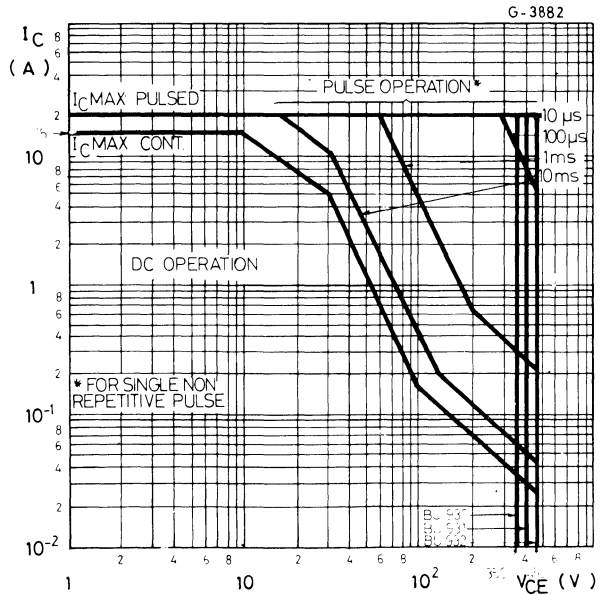

Thermal transient response

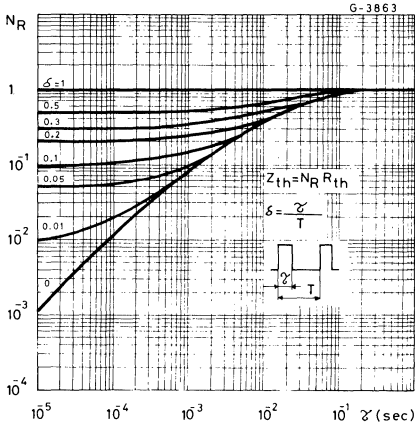

DC current gain

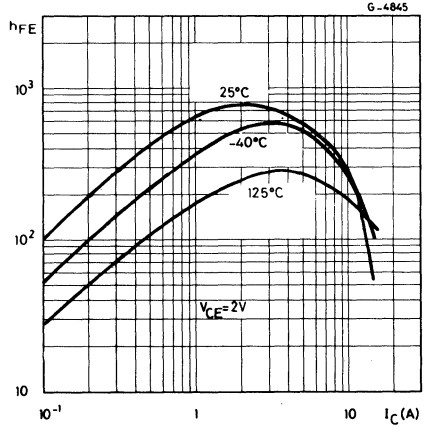

Collector-emitter saturation voltage

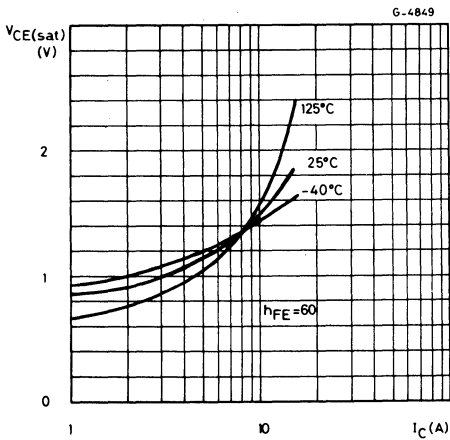

Base-emitter saturation voltage

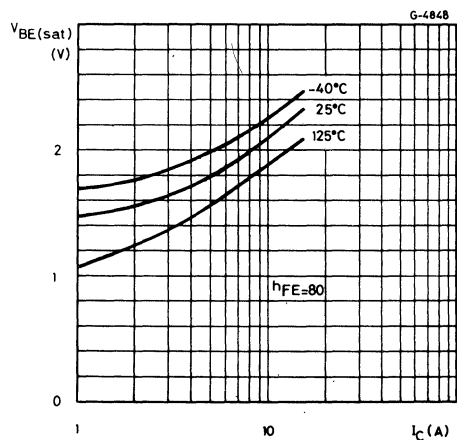

Collector-emitter saturation voltage

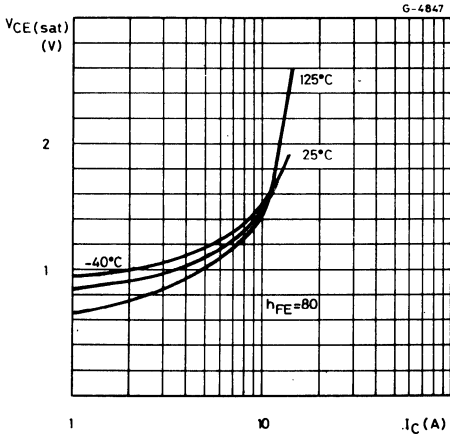

Base-emitter saturation voltage

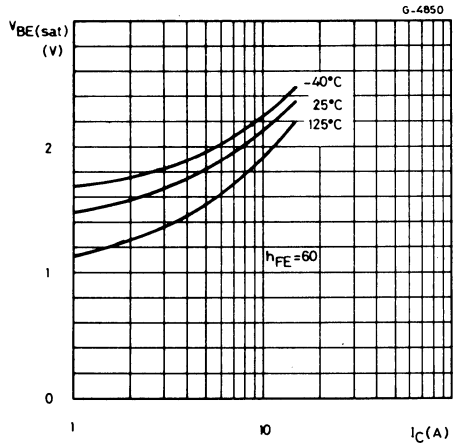

Collector-emitter saturation voltage

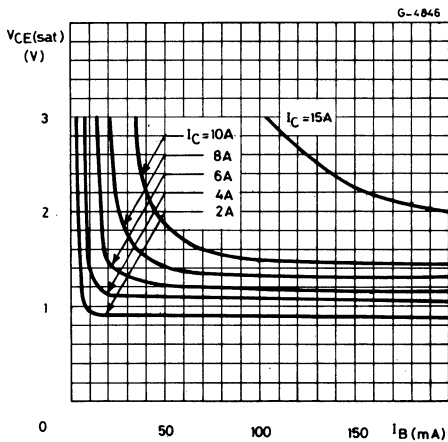

Saturated switching characteristics

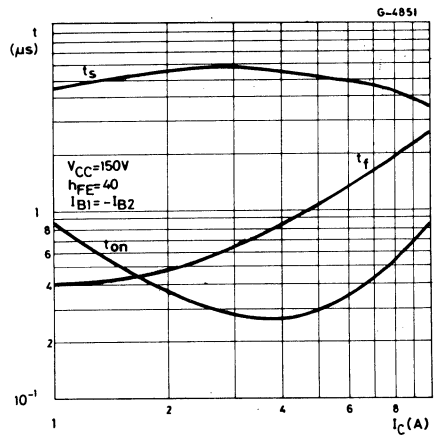

Clamped reverse bias safe operating areas

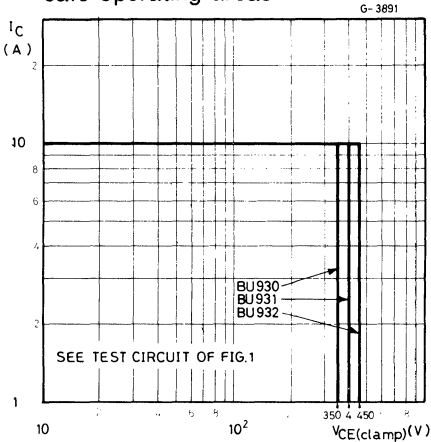

Fig. 1 — Clamped $E_{s/b}$ test circuit

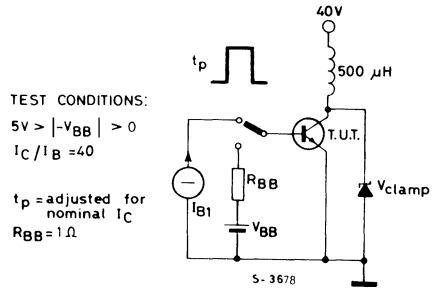

Fig. 2 — Functional test circuit

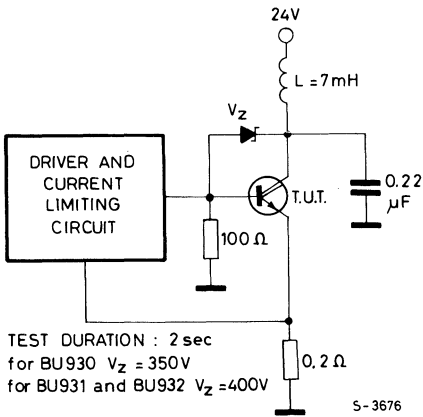
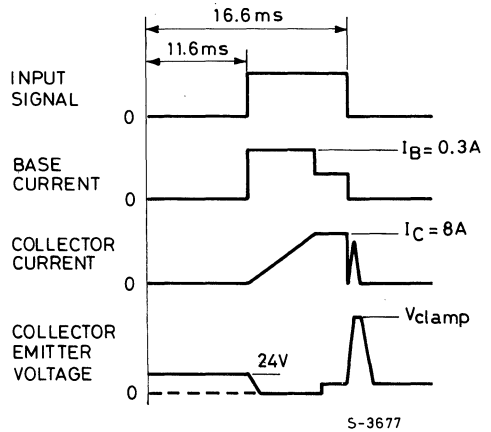

Fig. 3 — Functional test waveforms



MULTIEPITAXIAL PLANAR NPN



AUTOMOTIVE IGNITION DARLINGTON

The BU930P, BU931P and BU932P are high voltage silicon NPN Darlington transistors in SOT-93 specially intended for automotive ignition application and inverter circuits for motor controls.

ABSOLUTE MAXIMUM RATINGS

		BU930P	BU931P	BU932P
V_{CES}	Collector-emitter voltage ($V_{BE} = 0$)	400V	450V	500V
V_{CEO}	Collector-emitter voltage ($I_B = 0$)	350V	400V	450V
V_{EBO}	Emitter-base voltage ($I_C = 0$)		5V	
I_C	Collector current		15A	
I_{CM}	Collector peak current		20A	
I_B	Base current		1A	
P_{tot}	Total power dissipation $T_{case} \leq 25^\circ C$		105W	
T_{stg}	Storage temperature		-65 to 150°C	
T_j	Junction temperature		150°C	

INTERNAL SCHEMATIC DIAGRAM

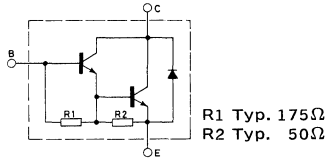

MECHANICAL DATA

Dimensions in mm

Collector connected to tab.

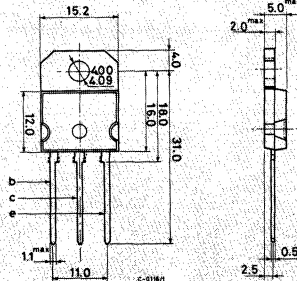

(sim. to TO-218) SOT-93



THERMAL DATA

$R_{th\ j-case}$	Thermal resistance junction-case	max. 1.2 °C/W
------------------	----------------------------------	---------------

ELECTRICAL CHARACTERISTICS ($T_{case} = 25^{\circ}C$ unless otherwise specified)

Parameter	Test conditions	Min.	Typ.	Max.	Unit
I_{CES} Collector cutoff current ($V_{BE} = 0$)	for BU930P $V_{CE} = 400V$ for BU931P $V_{CE} = 450V$ for BU932P $V_{CE} = 500V$ $T_{case} = 150^{\circ}C$ for BU930P $V_{CE} = 400V$ for BU931P $V_{CE} = 450V$ for BU932P $V_{CE} = 500V$			1 1 1 5 5 5	mA mA mA mA mA mA
I_{CEO} Collector cutoff current ($I_B = 0$)	for BU930P $V_{CE} = 350V$ for BU931P $V_{CE} = 400V$ for BU932P $V_{CE} = 450V$			1 1 1	mA mA mA
I_{EBO} Emitter cutoff current ($I_C = 0$)	$V_{EB} = 5V$			50	mA
$V_{CEO(sus)}$ * Collector-emitter sustaining voltage	$I_C = 100mA$ for BU930P for BU931P for BU932P			350 400 450	V V V
$V_{CE(sat)}$ * Collector-emitter saturation voltage	for BU930P and BU931P $I_C = 7A$ $I_B = 70mA$ $I_C = 8A$ $I_B = 100mA$ $I_C = 10A$ $I_B = 250mA$ for BU932P $I_C = 8A$ $I_B = 150mA$			1.6 1.8 1.8 1.8	V V V V
$V_{BE(sat)}$ * Base-emitter saturation voltage	for BU930P and BU931P $I_C = 8A$ $I_B = 100mA$ $I_C = 10A$ $I_B = 250mA$ for BU932P $I_C = 8A$ $I_B = 150mA$			2.2 2.5 2.2	V V V
V_F * Diode forward voltage	$I_F = 10A$			2.5	V

* Pulsed: pulse duration = 300 μs , duty cycle = 1.5%.

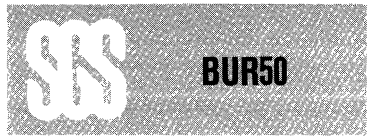

MULTIEPITAXIAL PLANAR NPN

HIGH CURRENT, HIGH SPEED, HIGH POWER TRANSISTOR

The BUR 50 is a silicon multi-epitaxial planar NPN transistor in modified JEDEC TO-3 metal case, intended for use in switching and linear applications in military and industrial equipment.

ABSOLUTE MAXIMUM RATINGS

V_{CBO}	Collector-base voltage ($I_E=0$)	200	V
V_{CEO}	Collector-emitter voltage ($I_B=0$)	125	V
V_{EBO}	Emitter-base voltage ($I_C=0$)	10	V
I_C	Collector current	70	A
I_{CM}	Collector peak current ($t_p=10\text{ ms}$)	100	A
I_B	Base current	20	A
P_{tot}	Total power dissipation at $T_{case} \leq 25^\circ\text{C}$	350	W
T_{stg}	Storage temperature	-65 to 200	$^\circ\text{C}$
T_j	Junction temperature	200	$^\circ\text{C}$

INTERNAL SCHEMATIC DIAGRAM

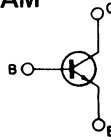

MECHANICAL DATA

Dimensions in mm

Collector connected to case

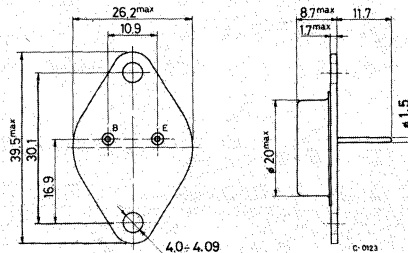

TO-3



BUR50

THERMAL DATA

$R_{th\ j-case}$	Thermal resistance junction-case	max 0.5	°C/W
------------------	----------------------------------	---------	------

ELECTRICAL CHARACTERISTICS ($T_{case} = 25^{\circ}C$ unless otherwise specified)

Parameter	Test conditions	Min. Typ. Max.	Unit
I_{CBO} Collector cutoff current ($I_E = 0$)	$V_{CB} = 200V$ $V_{CB} = 200V$ $T_{case} = 125^{\circ}C$	0.2 2	mA mA
I_{CEO} Collector cutoff current ($I_B = 0$)	$V_{CE} = 125V$	1	mA
I_{EBO} Emitter cutoff current ($I_C = 0$)	$V_{EB} = 7V$	0.2	mA
$V_{CEO(sus)}$ *Collector-emitter sustaining voltage	$I_C = 200mA$	125	V
V_{EBO} Emitter-base voltage ($I_C = 0$)	$I_E = 10mA$	10	V
$V_{CE(sat)}$ * Collector-emitter saturation voltage	$I_C = 35A$ $I_B = 2A$ $I_C = 70A$ $I_B = 7A$	0.8 1 1.5	V V
$V_{BE(sat)}$ * Base-emitter saturation voltage	$I_C = 35A$ $I_B = 2A$ $I_C = 70A$ $I_B = 7A$	1.6 1.8 2	V V
h_{FE} * DC current gain	$I_C = 5A$ $V_{CE} = 4V$ $I_C = 50A$ $V_{CE} = 4V$	20 100	— —
$I_{s/b}$ Second breakdown collector current	$V_{CE} = 20V$ $t = 1s$	17.5	A
f_T Transition frequency	$I_C = 1A$ $V_{CE} = 5V$ $f = 1MHz$	10 16	MHz

ELECTRICAL CHARACTERISTICS (continued)

Parameter	Test conditions	Min. Typ. Max.	Unit
t_{on} Turn-on time (fig. 2)	$I_C = 70A$ $I_{B1} = 7A$ $V_{CC} = 60V$	0.5 1.2	μs
t_s Storage time (fig. 2)	$I_C = 70A$ $I_{B1} = 7A$ $I_{B2} = -7A$ $V_{CC} = 60V$	0.82 2	μs
t_f Fall time (fig. 2)		0.1 0.5	μs
Clamped $E_{s/b}$ Collector current (fig. 1)	$V_{clamp} = 125V$ $L = 500\mu H$	70	A

* Pulsed: pulse duration = 300 μs , duty cycle $\leq 2\%$

Safe operating areas

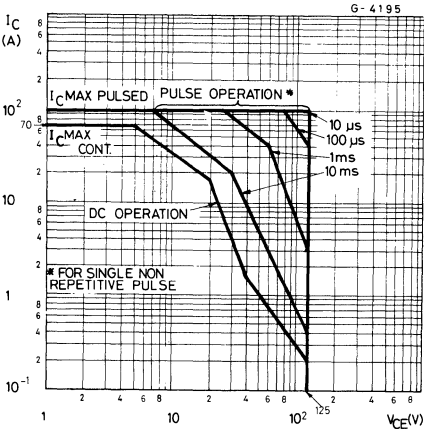

Derating curves

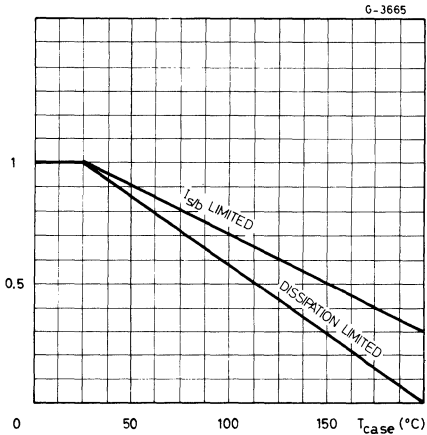



BUR50

Thermal transient response

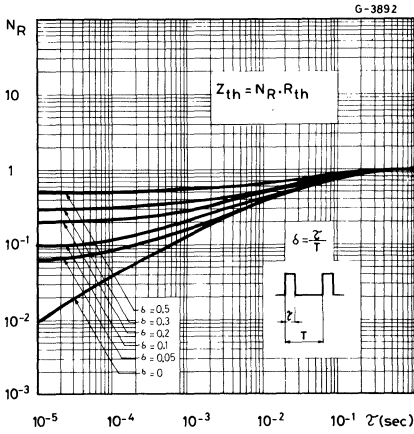

DC current gain

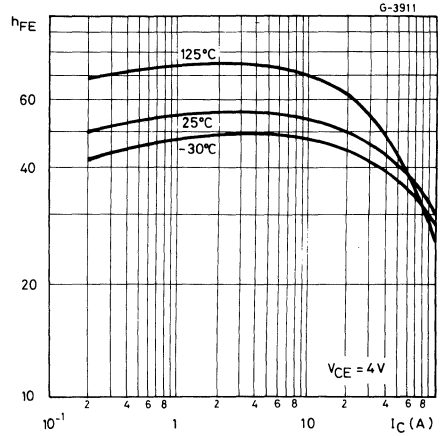

Collector-emitter saturation voltage

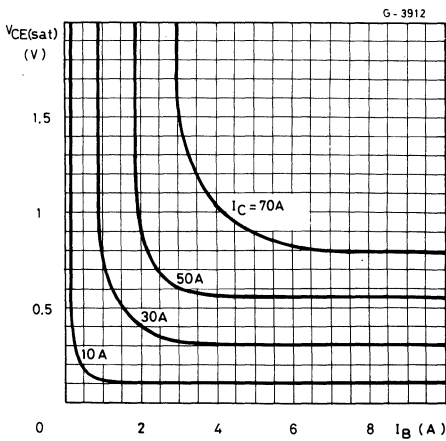

Collector-emitter saturation voltage

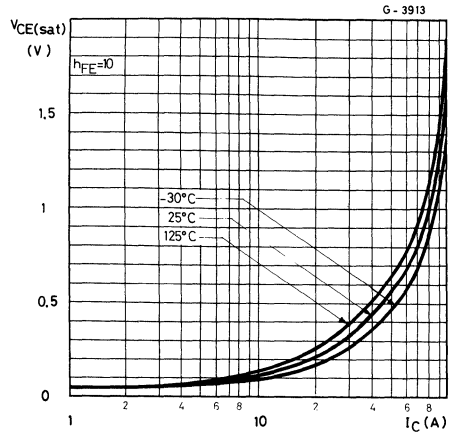

Base-emitter saturation voltage

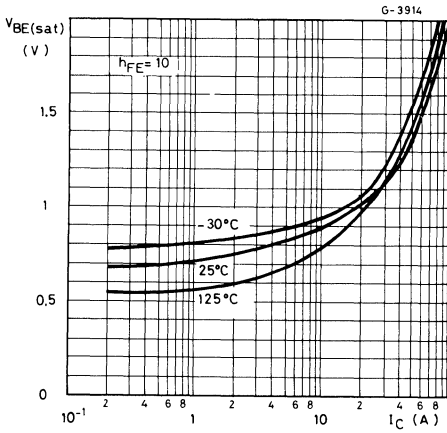

Saturated switching characteristics

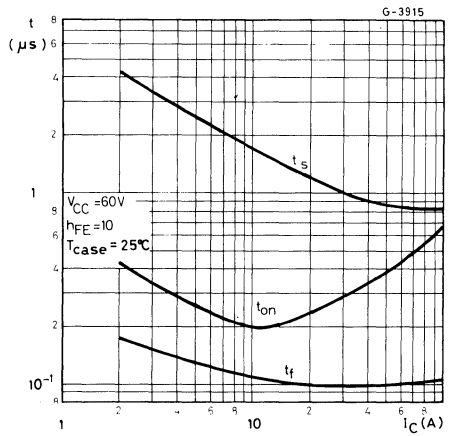

Saturated switching characteristics

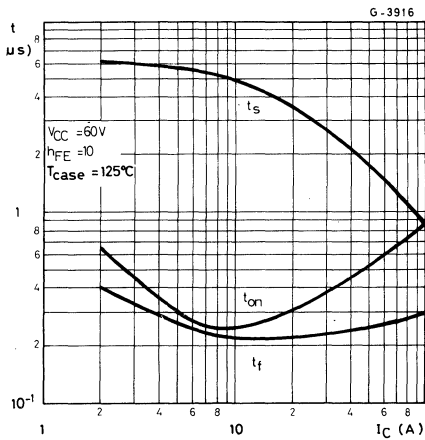

Transition frequency

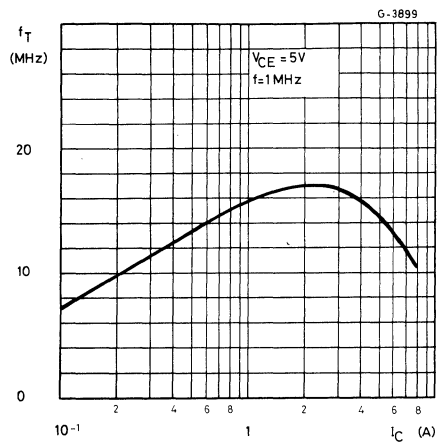

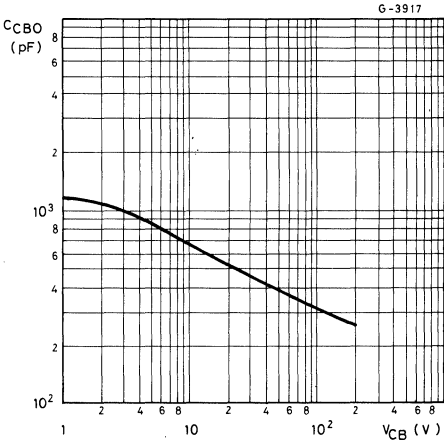
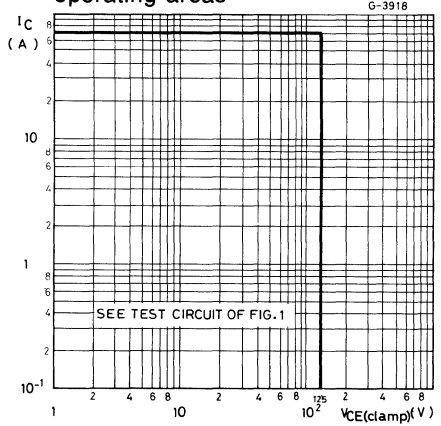
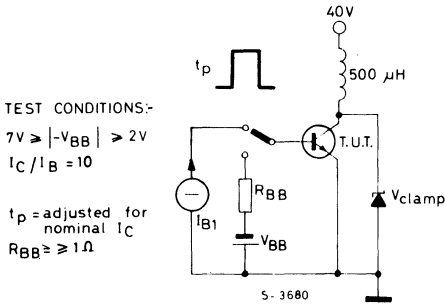
Collector-base capacitance

Clamped reverse bias safe operating areas

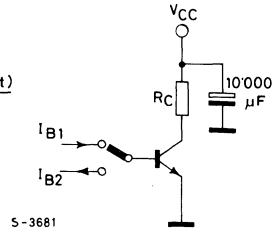
Fig. 1 — Clamped $E_{s,b}$ test circuit

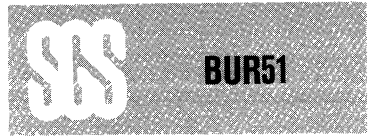
Fig. 2 — Switching times test circuit (resistive load)
TEST CONDITIONS:
 $V_{CC} = 60V$

$$R_C = \frac{V_{CC} - V_{CE}(\text{sat})}{I_C}$$

INPUT PULSE
 pulse width = $10\mu s$
 $t_r, t_f \leq 50ns$
 duty cycle = 1%



MULTIEPITAXIAL PLANAR NPN

HIGH CURRENT, HIGH SPEED, HIGH POWER TRANSISTOR

The BUR 51 is a silicon multiepitaxial planar NPN transistor in modified Jeduc TO-3 metal case, intended for use in switching and linear applications in military and industrial equipment.

ABSOLUTE MAXIMUM RATINGS

V_{CBO}	Collector-base voltage ($I_E = 0$)	300	V
V_{CEO}	Collector-emitter voltage ($I_B = 0$)	200	V
V_{EBO}	Emitter-base voltage ($I_C = 0$)	10	V
I_C	Collector current	60	A
I_{CM}	Collector peak current ($t_p = 10$ ms)	80	A
I_B	Base current	16	A
P_{tot}	Total power dissipation at $T_{case} \leq 25^\circ C$	350	W
T_{stg}	Storage temperature	-65 to 200	$^\circ C$
T_j	Junction temperature	200	$^\circ C$

INTERNAL SCHEMATIC DIAGRAM

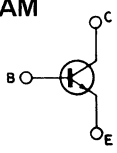

MECHANICAL DATA

Dimensions in mm

Collector connected to case

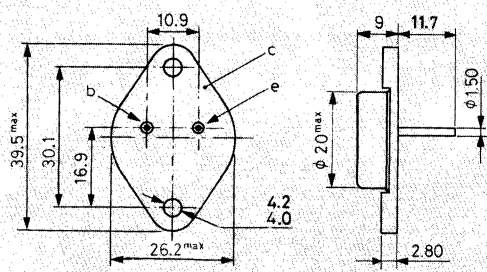

C - 0008 / 1

Modified TO-3

**BUR51****THERMAL DATA**

$R_{th\ j-case}$	Thermal resistance junction-case	max	0.5	°C/W
------------------	----------------------------------	-----	-----	------

ELECTRICAL CHARACTERISTICS ($T_{case} = 25^\circ\text{C}$ unless otherwise specified)

Parameter	Test conditions	Min.	Typ.	Max.	Unit
I_{CBO}	Collector cutoff current ($I_E=0$) $V_{CB}=300\text{V}$ $V_{CB}=300\text{V}$ $T_{case}=125^\circ\text{C}$			0.2 2	mA mA
I_{CEO}	Collector cutoff current ($I_B=0$) $V_{CE}=200\text{V}$			1	mA
I_{EBO}	Emitter cutoff current ($I_C=0$) $V_{EB}=7\text{V}$			0.2	mA
$V_{CEO(sus)}$	*Collector-emitter sustaining voltage $I_C = 200\text{mA}$			200	V
V_{EBO}	Emitter-base voltage ($I_C=0$) $I_E = 10\text{mA}$			10	V
$V_{CE(sat)}$	* Collector-emitter saturation voltage $I_C = 30\text{A}$ $I_B = 2\text{A}$ $I_C = 50\text{A}$ $I_B = 5\text{A}$			0.9 1 1.5	V V
$V_{BE(sat)}$	* Base-emitter saturation voltage $I_C = 30\text{A}$ $I_B = 2\text{A}$ $I_C = 50\text{A}$ $I_B = 5\text{A}$			1.55 1.8 2	V V
h_{FE}	* DC current gain $I_C = 5\text{A}$ $V_{CE}=4\text{V}$ $I_C = 50\text{A}$ $V_{CE}=4\text{V}$			20 100 15	— —
$I_{s,b}$	Second breakdown collector current $V_{CE}=20\text{V}$ $t = 1\text{s}$			17.5	A
f_T	Transition frequency $I_C = 1\text{A}$ $V_{CE}=5\text{V}$ $f = 1\text{MHz}$			10 16	MHz

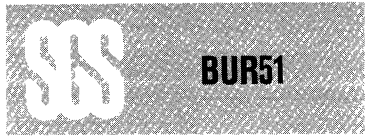

ELECTRICAL CHARACTERISTICS (continued)

Parameter		Test conditions	Min. Typ. Max.	Unit
t_{on}	Turn-on time (fig. 2)	$I_C = 50A$ $V_{CC} = 100V$	$I_{B1} = 5A$	0.35 1 μs
t_s	Storage time (fig. 2)	$I_C = 50A$ $I_{B2} = -5A$	$I_{B1} = 5A$ $V_{CC} = 100V$	0.9 2 μs
t_f	Fall time (fig. 2)			0.24 0.6 μs
Clamped $E_{s/b}$ Collector current (fig. 1)		$V_{clamp} = 200V$ $L = 500\mu H$		50 A

* Pulsed: pulse duration = 300 μs , duty cycle $\leq 2\%$

Safe operating areas

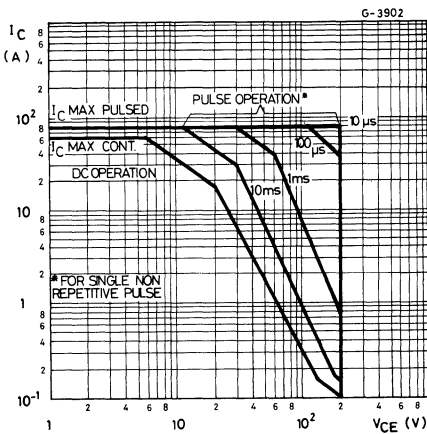

Derating curves

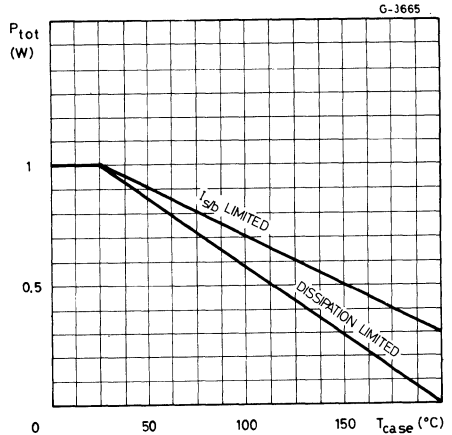

Thermal transient response

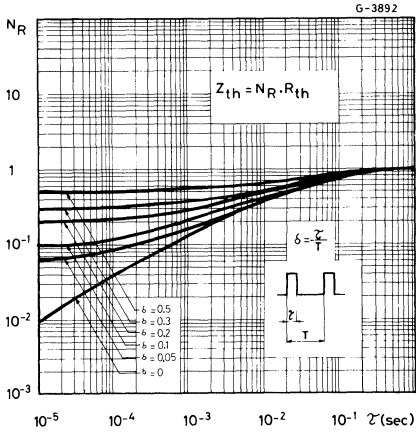

DC current gain

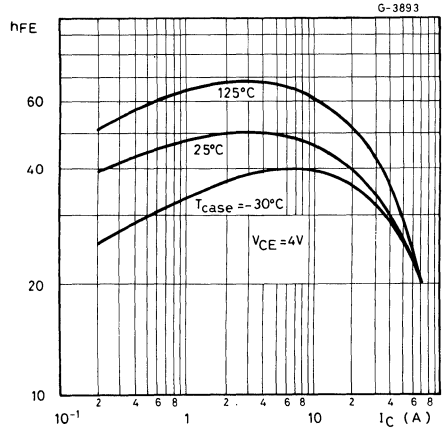

Collector-emitter saturation voltage

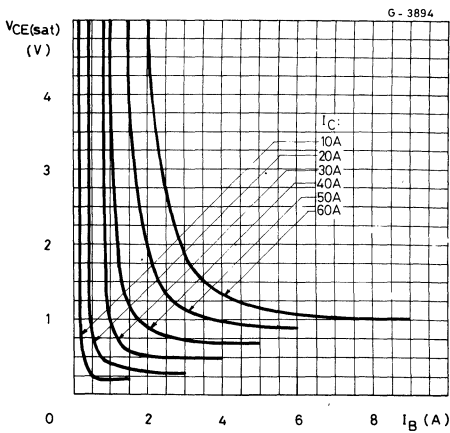

Collector-emitter saturation voltage

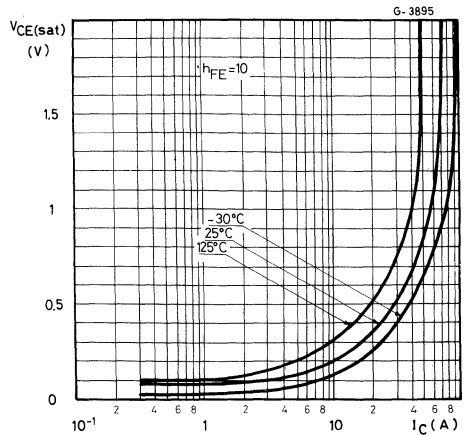

Base-emitter saturation voltage

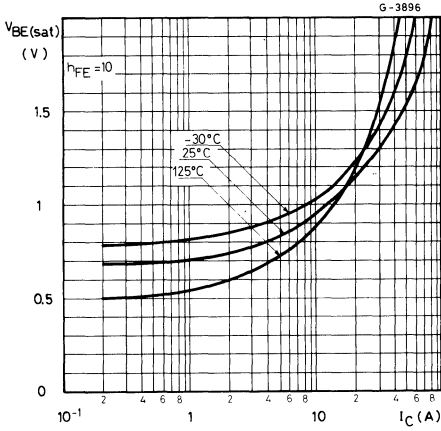

Saturated switching characteristics

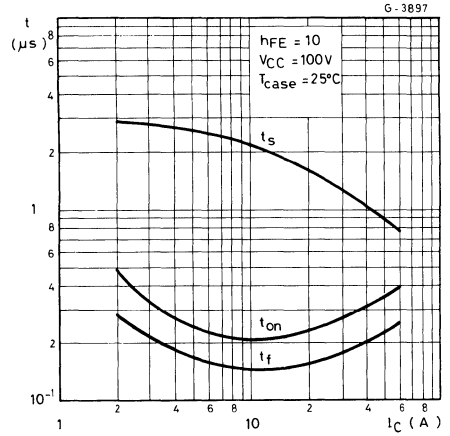

Saturated switching characteristics

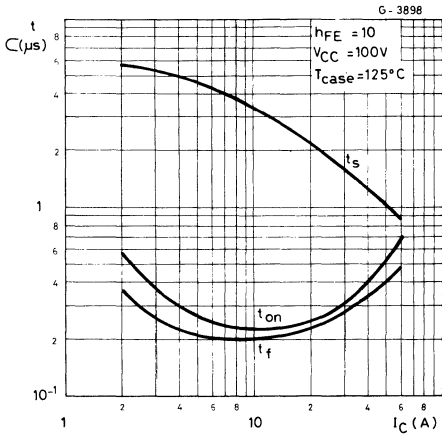

Transition frequency

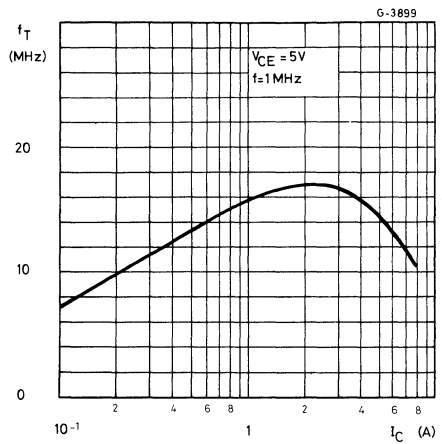

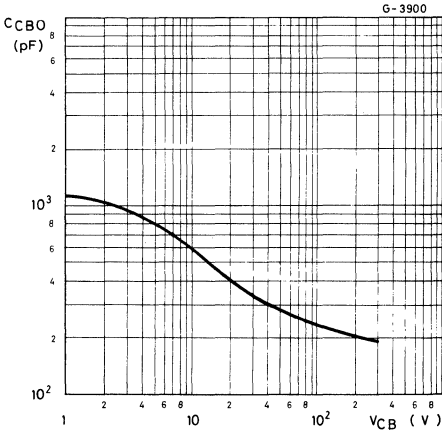
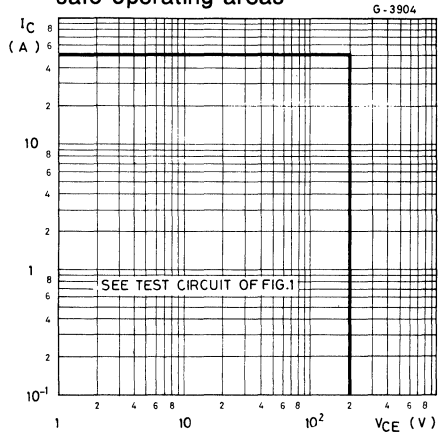
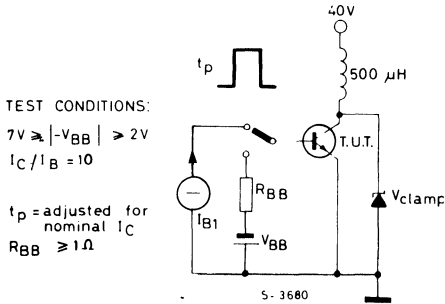
Collector-base capacitance

Clamped reverse bias safe operating areas

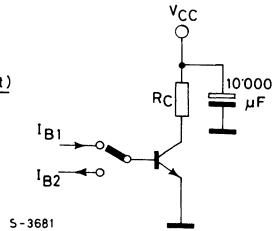
Fig. 1 — Clamped $E_{s/b}$ test circuit

Fig. 2 — Switching times test circuit (resistive load)

TEST CONDITIONS:
 $V_{CC} = 100V$
 $R_C = \frac{V_{CC} - V_{CE(sat)}}{I_C}$
 INPUT PULSE
 pulse width = $10 \mu s$
 $t_r, t_f \leq 50ns$
 duty cycle = 1%





MULTIEPITAXIAL PLANAR NPN

HIGH CURRENT, HIGH SPEED, HIGH POWER TRANSISTOR

The BUR 52 is a silicon multiepitaxial planar NPN transistor in modified Jedec TO-3 metal case, intended for use in switching and linear applications in military and industrial equipment.

ABSOLUTE MAXIMUM RATINGS

V_{CBO}	Collector-base voltage ($I_E=0$)	350	V
V_{CEO}	Collector-emitter voltage ($I_B=0$)	250	V
V_{EBO}	Emitter-base voltage ($I_C=0$)	10	V
I_C	Collector current	60	A
I_{CM}	Collector peak current ($t_p=10$ ms)	80	A
I_B	Base current	16	A
P_{tot}	Total power dissipation at $T_{case} \leq 25^\circ C$	350	W
T_{stg}	Storage temperature	-65 to 200	$^\circ C$
T_j	Junction temperature	200	$^\circ C$

INTERNAL SCHEMATIC DIAGRAM

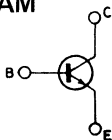

MECHANICAL DATA

Dimensions in mm

Collector connected to case

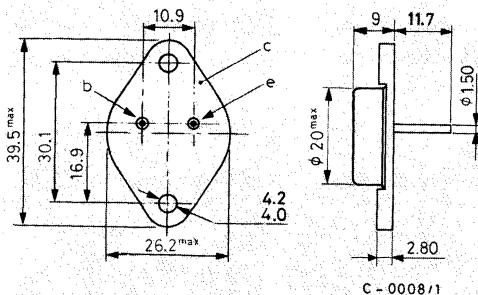

Modified TO-3



BUR52

THERMAL DATA

$R_{th\ j-case}$	Thermal resistance junction-case	max 0.5 °C/W
------------------	----------------------------------	--------------

ELECTRICAL CHARACTERISTICS ($T_{case} = 25^{\circ}C$ unless otherwise specified)

Parameter	Test conditions	Min. Typ. Max.	Unit
I_{CBO} Collector cutoff current ($I_E=0$)	$V_{CB}=350V$ $V_{CB}=350V$ $T_{case}=125^{\circ}C$	0.2 2	mA mA
I_{CEO} Collector cutoff current ($I_B=0$)	$V_{CE}=250V$	1	mA
I_{EBO} Emitter cutoff current ($I_C=0$)	$V_{EB}=7V$	0.2	mA
$V_{CEO(sus)}$ *Collector-emitter sustaining voltage	$I_C = 200mA$	250	V
V_{EBO} Emitter-base voltage ($I_C=0$)	$I_E = 10mA$	10	V
$V_{CE(sat)}$ * Collector-emitter saturation voltage	$I_C = 25A$ $I_B = 2A$ $I_C = 40A$ $I_B = 4A$	1 0.70 1.5	V V
$V_{BE(sat)}$ * Base-emitter saturation voltage	$I_C = 25A$ $I_B = 2A$ $I_C = 40A$ $I_B = 4A$	1.8 1.5 2	V V
h_{FE} * DC current gain	$I_C = 5A$ $V_{CE}=4V$ $I_C = 40A$ $V_{CE}=4V$	20 100 15	— —
$I_{s/b}$ Second breakdown collector current	$V_{CE}=20V$ $t = 1s$	17.5	A
f_T Transition frequency	$I_C = 1A$ $V_{CE}=5V$ $f = 1MHz$	10 16	MHz
t_{on} Turn-on time (fig. 2)	$I_C = 40A$ $I_{B1} = 4A$ $V_{CC}=100V$	0.3 1	μs

ELECTRICAL CHARACTERISTICS (continued)

Parameter	Test conditions	Min.	Typ.	Max.	Unit
t_s Storage time (fig. 2)	$I_C = 40A$ $I_{B1} = 4A$ $I_{B2} = -4A$ $V_{CC} = 100V$	1.2		2	μs
t_f Fall time (fig. 2)		0.20		0.6	μs
Clamped $E_{s,b}$ Collector current (fig. 1)	$V_{clamp} = 250V$ $L = 500\mu H$	40			A

* Pulsed: pulse duration = 300 μs , duty cycle $\leq 2\%$

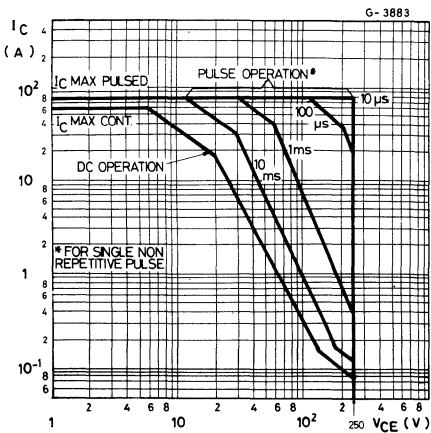
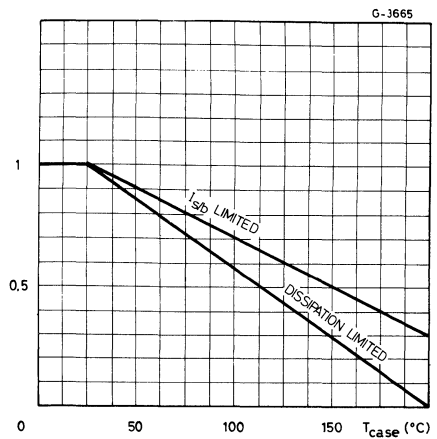
Safe operating areas

Derating curves

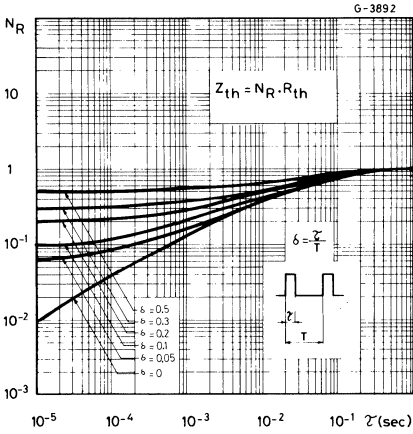
Thermal transient response

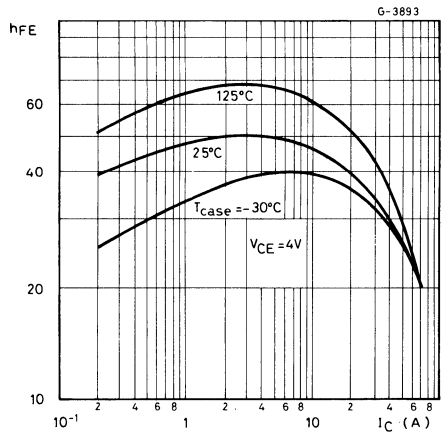

DC current gain



Collector-emitter saturation voltage

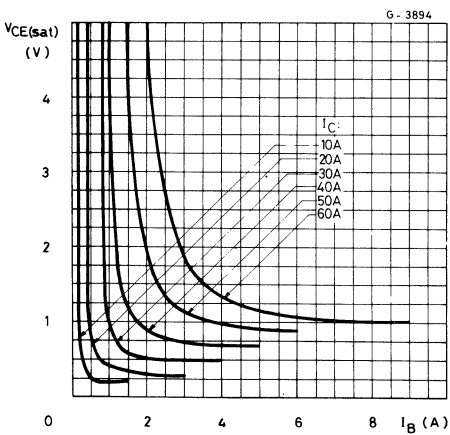

Collector-emitter saturation voltage

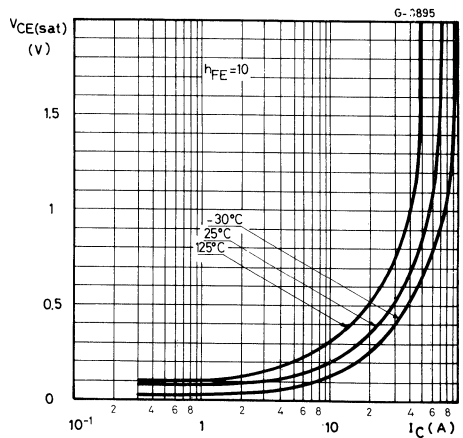



Base-emitter saturation voltage

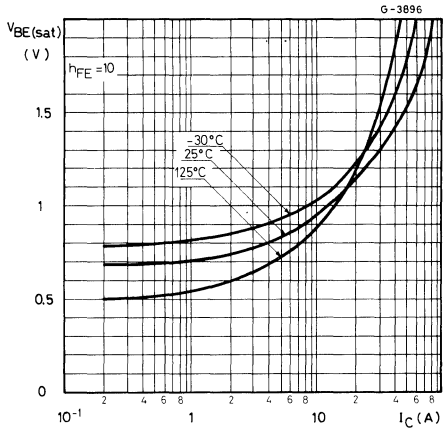

Saturated switching characteristics

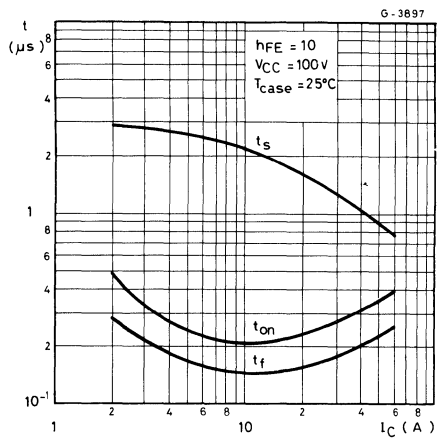

Saturated switching characteristics

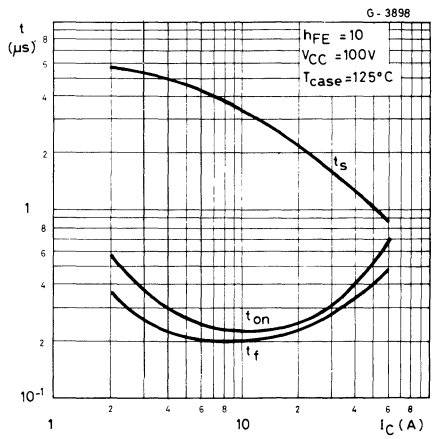

Transition frequency

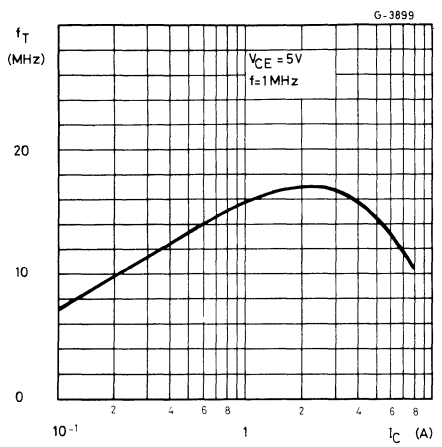

Collector-base capacitance

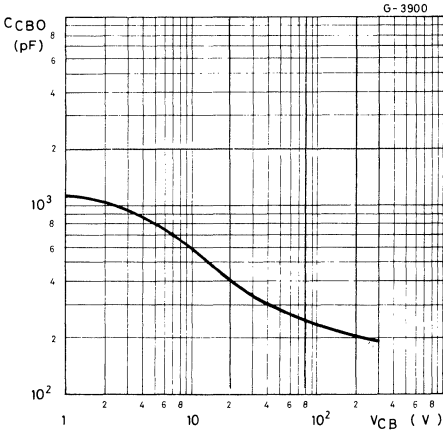

Clamped reverse bias safe operating areas

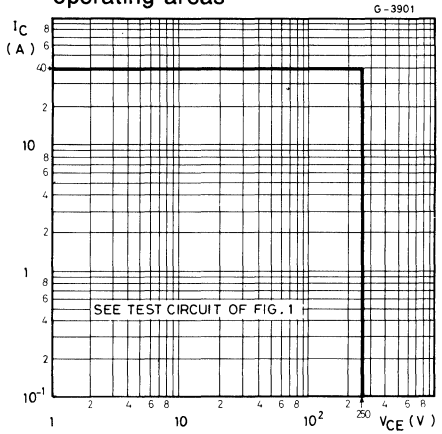
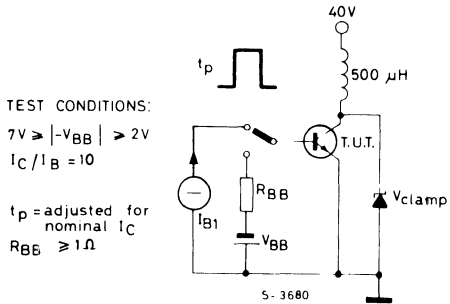
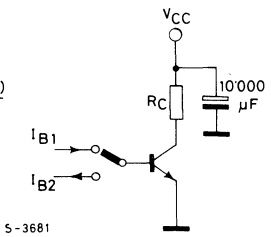

Fig. 1 – Clamped $E_{s,b}$ test circuit

Fig. 2 – Switching times test circuit (resistive load)



TEST CONDITIONS:
 $V_{CC} = 100V$
 $R_C = \frac{V_{CC} - V_{CE(sat)}}{I_C}$
 INPUT PULSE
 pulse width = $10 \mu s$
 $t_r, t_f \leq 50ns$
 duty cycle = 1%



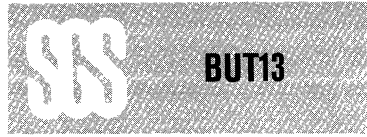

EPITAXIAL PLANAR NPN

HIGH VOLTAGE, HIGH POWER, FAST SWITCHING

The BUT13 is a silicon epitaxial planar NPN Darlington transistor with integrated base-emitter speed-up diode, mounted in jedec TO-3 metal case. It is particularly suitable as output stage in high power, fast switching applications.

ABSOLUTE MAXIMUM RATINGS

V_{CB0}	Collector-base voltage ($I_E = 0$)	600	V
V_{CEO}	Collector-emitter voltage ($I_B = 0$)	400	V
V_{EBO}	Emitter-base voltage ($I_C = 0$)	10	V
I_C	Collector current	28	A
I_{CM}	Collector peak current ($t_p = 10\text{ms}$)	35	A
I_B	Base current	6	A
P_{tot}	Total power dissipation $T_{case} \leq 25^\circ\text{C}$	175	W
T_{stg}	Storage temperature	-65 to 200	$^\circ\text{C}$
T_j	Junction temperature	200	$^\circ\text{C}$

INTERNAL SCHEMATIC DIAGRAM

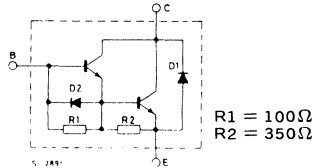

MECHANICAL DATA

Dimensions in mm

Collector connected to case

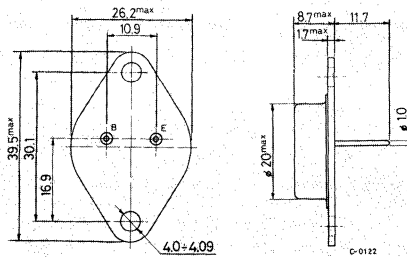

TO-3

**BUT13****THERMAL DATA**

$R_{th\ j-case}$	Thermal resistance junction-case	max.	1	°C/W
------------------	----------------------------------	------	---	------

ELECTRICAL CHARACTERISTICS ($T_{case} = 25^{\circ}C$ unless otherwise specified)

Parameter		Test conditions	Min.	Typ.	Max.	Unit	
I_{CEV}	Collector cutoff current ($V_{BE} = -1.5V$)	$V_{CE} = 600V$ $V_{CE} = 600V$ $T_{case} = 100^{\circ}C$		100	2	μA mA	
I_{CEO}	Collector cutoff current ($I_B = 0$)	$V_{CE} = 400V$			1	mA	
I_{EBO}^*	Emitter cutoff current ($I_C = 0$)	$V_{EB} = 2V$			175	mA	
$V_{CEO(sus)}^*$	Collector cutoff sustaining voltage	$I_C = 100mA$	400			V	
$V_{CE(sat)}^*$	Collector-emitter saturation voltage	$I_C = 10A$ $I_B = 0.5A$ $I_C = 18A$ $I_B = 1.8A$ $I_C = 22A$ $I_B = 2.2A$ $I_C = 28A$ $I_B = 5.6A$		2	2.5	3 5	V V V V
$V_{BE(sat)}^*$	Base-emitter saturation voltage	$I_C = 10A$ $I_B = 0.5A$ $I_C = 18A$ $I_B = 1.8A$ $I_C = 22A$ $I_B = 2.2A$		2.5	3	3.3	V V V
h_{FE}	DC current gain	$I_C = 10A$ $V_{CE} = 5V$ $I_C = 18A$ $V_{CE} = 5V$	30		20	V V	
V_F	Diode forward voltage	$I_F = 22A$			4	V	

RESISTIVE SWITCHING TIMES

t_{on}	Turn-on time	$V_{CC} = 250V$ $I_C = 10A$ $I_{B1} = 0.5A$ $V_{BE(off)} = -5V$	0.35	0.6	μs
t_s	Storage time		0.8	1.5	μs
t_f	Fall time		0.25	0.6	μs

ELECTRICAL CHARACTERISTICS (continued)

Parameter	Test conditions	Min.	Typ.	Max.	Unit
-----------	-----------------	------	------	------	------

INDUCTIVE SWITCHING TIMES

t_s	Storage time	$V_{Clamp} = 250V$ $I_C = 10A$	0.8	1.5	μs
t_f	Fall time	$I_{B1} = 0.5A$; $V_{BE(off)} = -5V$	0.08	0.5	μs
t_s	Storage time	$V_{Clamp} = 250V$ $I_C = 20A$	0.8	1.5	μs
t_f	Fall time	$I_{B1} = 2A$; $V_{BE(off)} = 5V$	0.35	0.7	μs

* Pulsed: pulse duration = 300 μs , duty cycle = 1.5%.

Safe operating areas

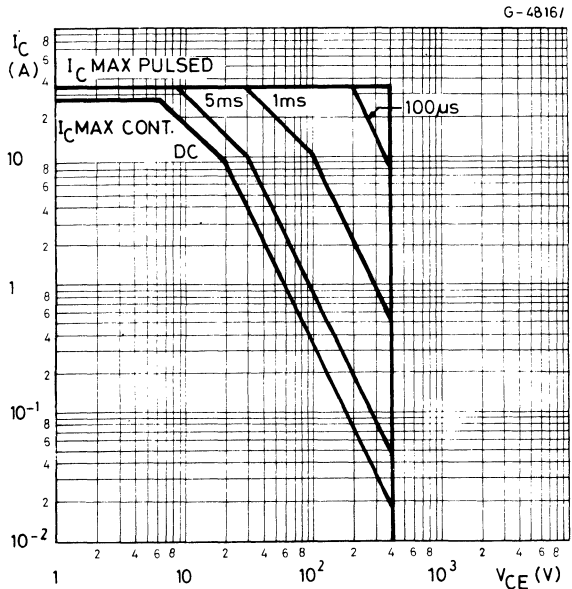

DC current gain

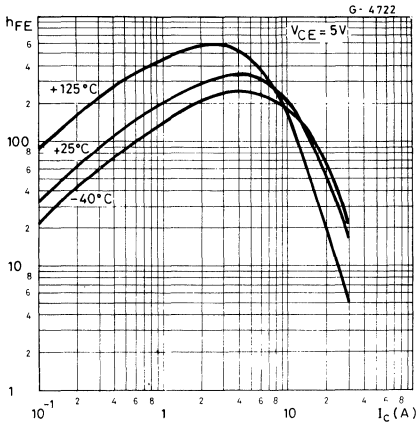

Collector-emitter saturation voltage

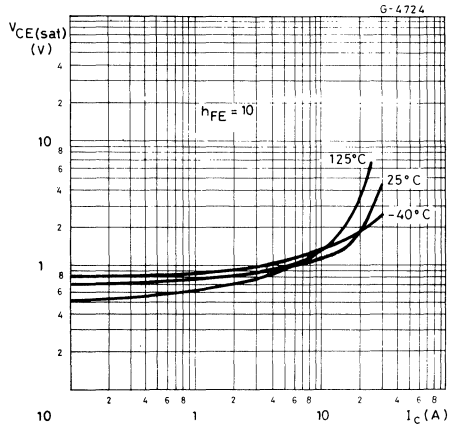

Collector-emitter saturation voltage

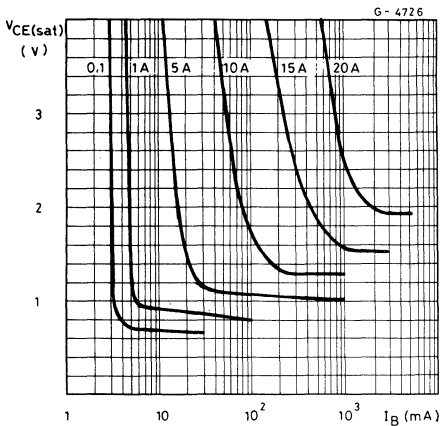

Base-emitter saturation voltage

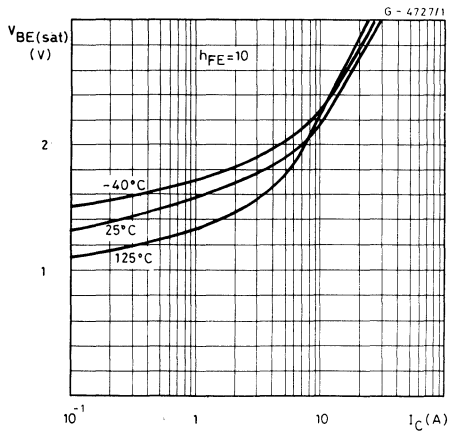

DC current gain

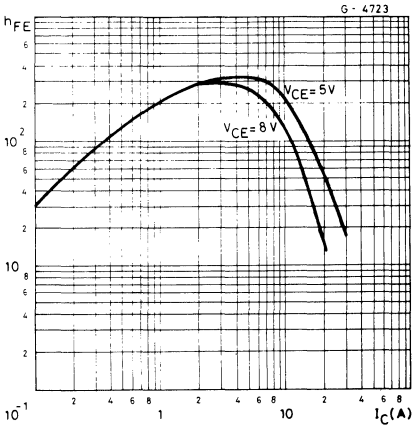

Collector-emitter saturation voltage

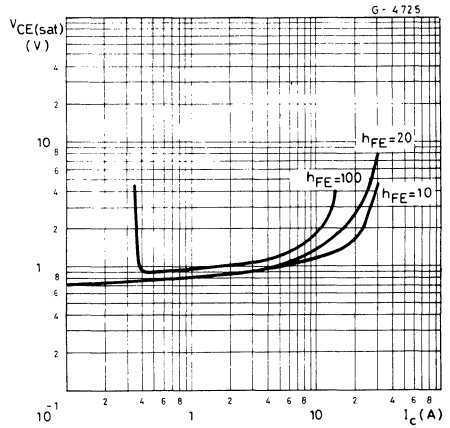

Base-emitter saturation voltage

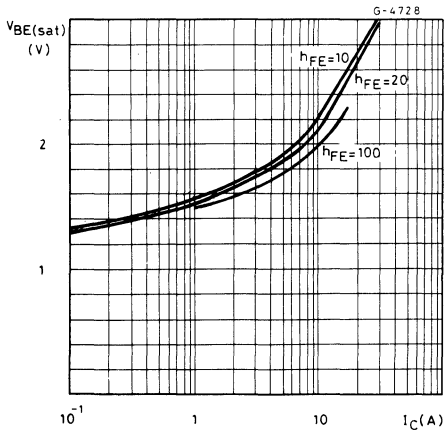

Collector base capacitance

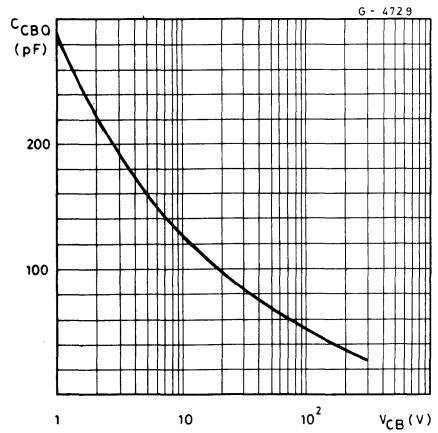



BUT13

Diode forward voltage

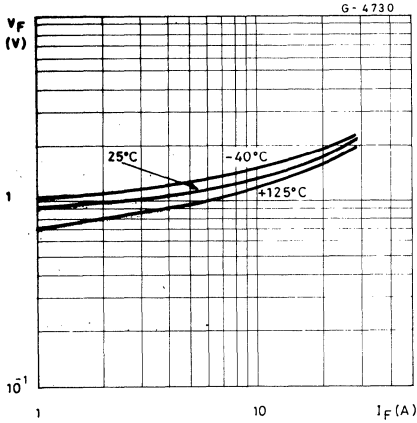

Collector cutoff current

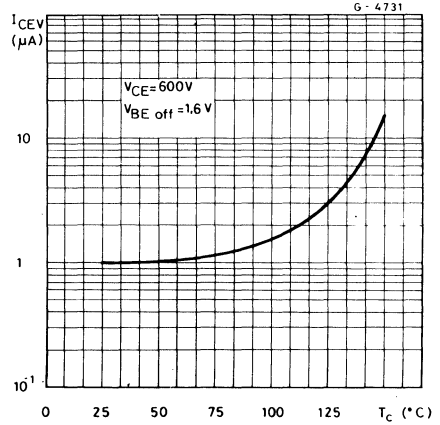

Reverse peak current

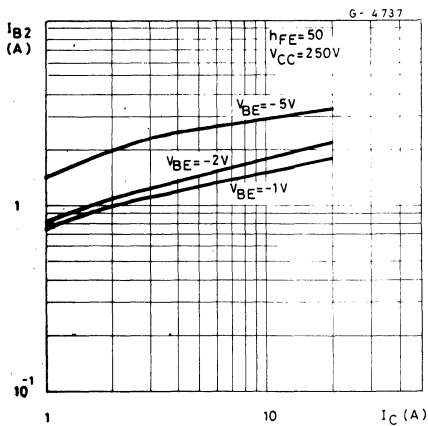

Saturated switching characteristics (resistive load)

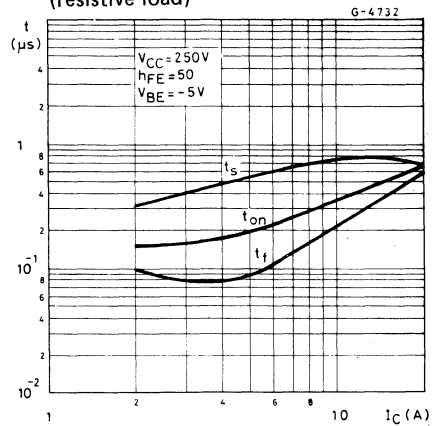

Saturated switching characteristics (inductive load)

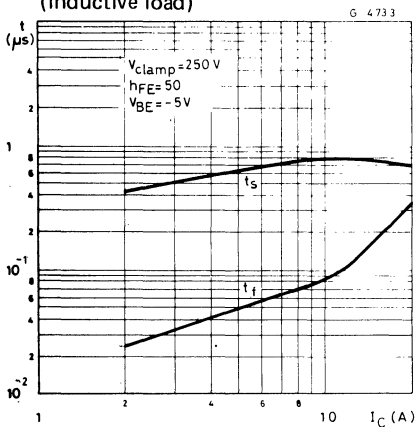

Fall time

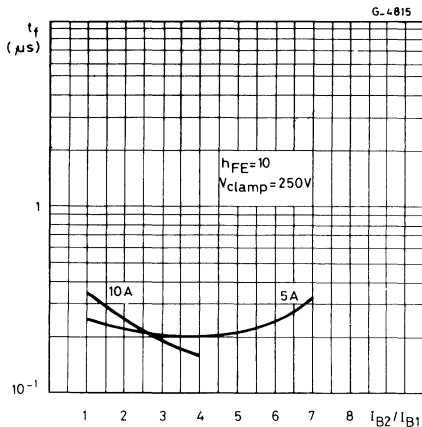

Storage time

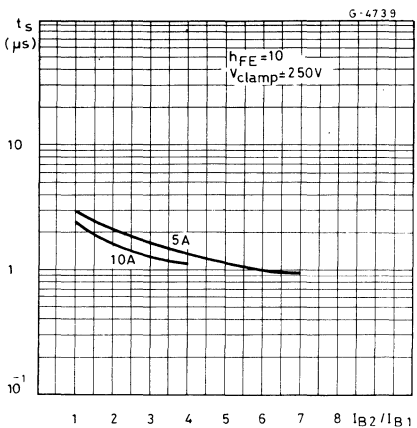

Storage time

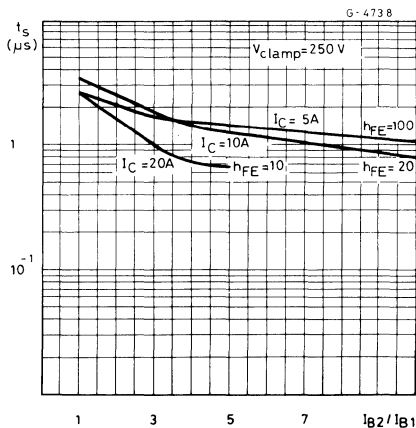



BUT13

Fall time

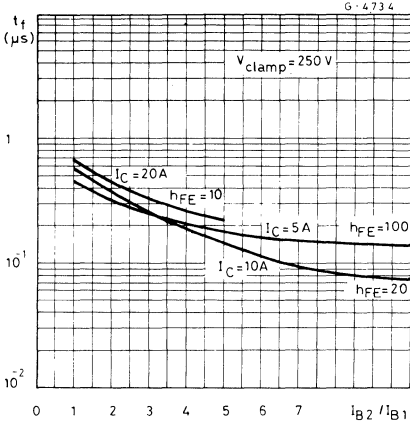

Clamped reverse bias safe operating area

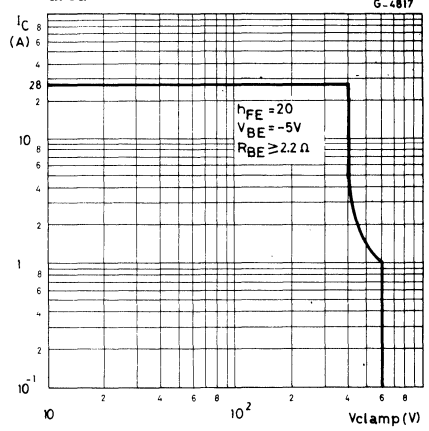

Overload safe operating areas

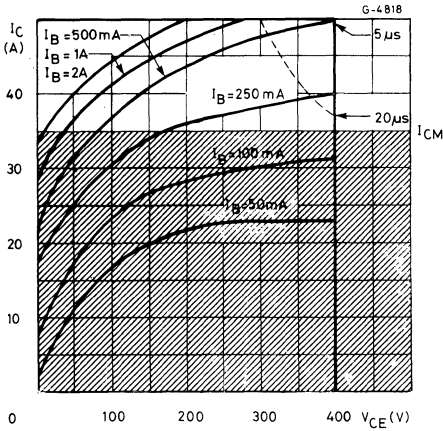

Thermal transient response

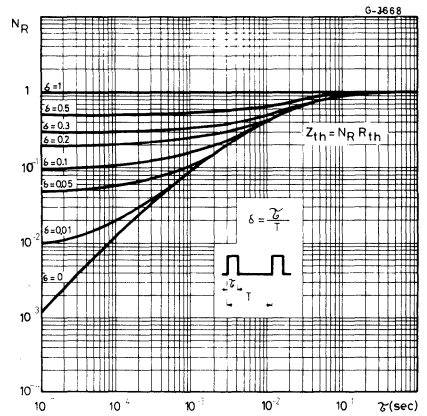

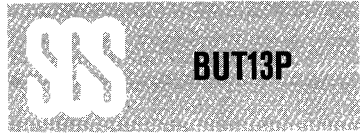

EPITAXIAL PLANAR NPN

HIGH VOLTAGE, HIGH POWER, FAST SWITCHING

The BUT13P is a silicon epitaxial planar NPN Darlington transistor with integrated base-emitter speed-up diode, mounted in SOT-93 plastic package.

It is particularly suitable as output stage in high power, fast switching applications.

ABSOLUTE MAXIMUM RATINGS

V_{CBO}	Collector-base voltage ($I_E = 0$)	600	V
V_{CEO}	Collector-emitter voltage ($I_B = 0$)	400	V
V_{EBO}	Emitter-base voltage ($I_C = 0$)	10	V
I_C	Collector current	28	A
I_{CM}	Collector peak current ($t_p = 10$ ms)	35	A
I_B	Base current	6	A
P_{tot}	Total power dissipation $T_{case} \leq 25^\circ\text{C}$	150	W
T_{stg}	Storage temperature	-65 to 175	$^\circ\text{C}$
T_j	Junction temperature	175	$^\circ\text{C}$

INTERNAL SCHEMATIC DIAGRAM

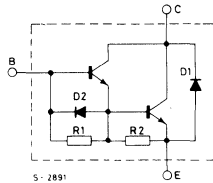

R1 TYP. 100 Ω
R2 TYP. 350 Ω

MECHANICAL DATA

Dimensions in mm

Collector connected to tab.

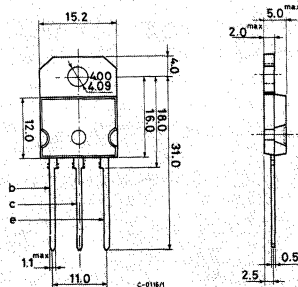

(sim. to TO-218) SOT-93



BUT13P

THERMAL DATA

$R_{th\ j-case}$ Thermal resistance junction-case	max 1 °C/W
---	------------

ELECTRICAL CHARACTERISTICS ($T_{case} = 25^{\circ}C$ unless otherwise specified)

Parameter	Test conditions	Min.	Typ.	Max.	Unit
I_{CEV}^* Collector cutoff current ($V_{BE} = -1.5V$)	$V_{CE} = 600V$ $V_{CE} = 600V (T_C = 100^{\circ}C)$			100 2	μA mA
I_{CEO} Collector cutoff current ($I_B = 0$)	$V_{CE} = 400V$			1	mA
I_{EBO}^* Emitter cutoff current ($I_C = 0$)	$V_{EB} = 2V$			175	mA
$V_{CEO(sus)}^*$ Collector-emitter sustaining voltage	$I_C = 100\ mA$	400			V
$V_{CE(sat)}^*$ Collector-emitter saturation voltage	$I_C = 10A$ $I_B = 0.5A$ $I_C = 18A$ $I_B = 1.8A$ $I_C = 22A$ $I_B = 2.2A$ $I_C = 28A$ $I_B = 5.6A$			2 2.5 3 5	V V V V
$V_{BE(sat)}^*$ Base-emitter saturation voltage	$I_C = 10A$ $I_B = 0.5A$ $I_C = 18A$ $I_B = 1.8A$ $I_C = 22A$ $I_B = 2.2A$			2.5 3 3.3	V V V
h_{FE} DC Current gain	$I_C = 10A$ $V_{CE} = 5V$ $I_C = 18A$ $V_{CE} = 5V$	30 20			– –
V_F Diode forward voltage	$I_F = 22A$			4	V

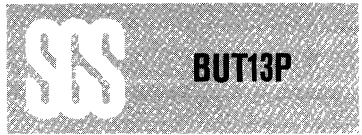

ELECTRICAL CHARACTERISTICS (continued)

Parameter	Test conditions	Min.	Typ.	Max.	Unit
-----------	-----------------	------	------	------	------

RESISTIVE SWITCHING TIMES

t_{on}	Turn-on time	$V_{CC} = 250V$ $I_C = 10A$ $I_{B1} = 0.5A$ $V_{BE(off)} = -5V$	0.35	0.6	μs
t_s	Storage time		0.8	1.5	μs
t_f	Fall time		0.25	0.6	μs

INDUCTIVE SWITCHING TIMES

t_s	Storage time	$V_{Clamp} = 250V$ $I_C = 10A$ $V_{BE(off)} = -5V$	$I_{B1} = 0.5A$	0.8	1.5	μs
t_f	Fall time			0.08	0.5	μs
t_s	Storage time	$V_{Clamp} = 250V$ $I_C = 20A$ $V_{BE(off)} = -5V$	$I_{B1} = 2A$	0.8	1.5	μs
t_f	Fall time			0.35	0.7	μs

* Pulsed: pulse duration = 300 μs , duty cycle = 1.5%



BUT13P

DC current gain

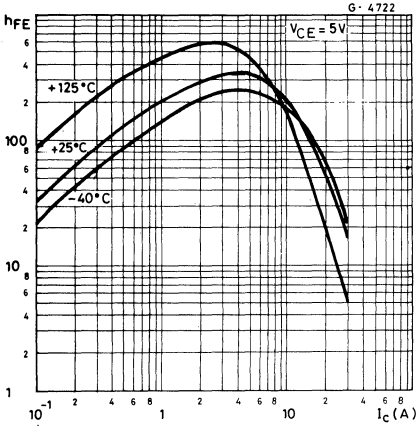

DC current gain

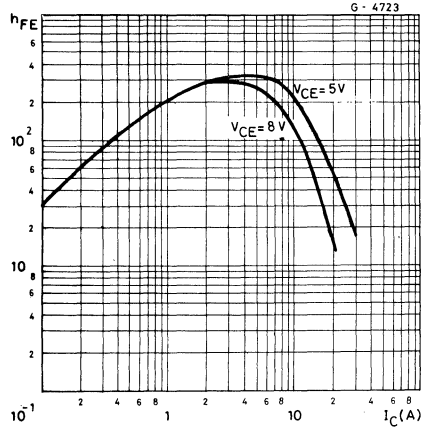

Collector-emitter saturation voltage

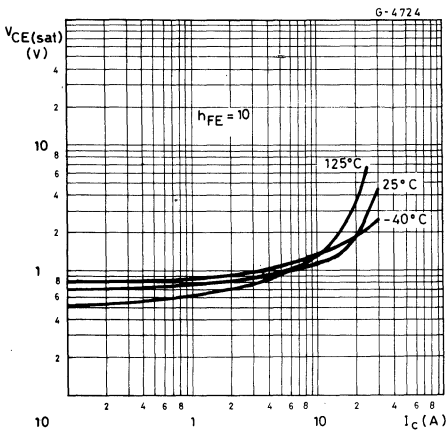

Collector-emitter saturation voltage

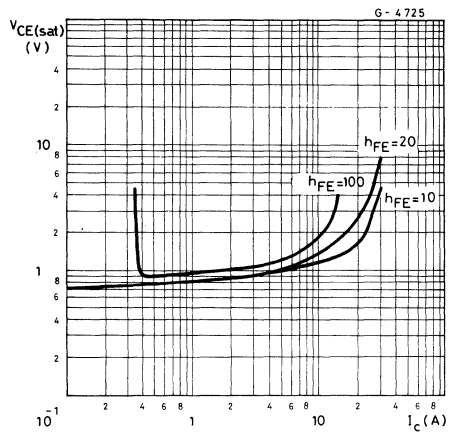

Collector-emitter saturation voltage

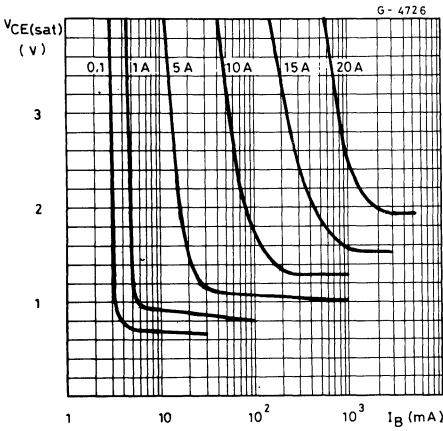

Base-emitter saturation voltage

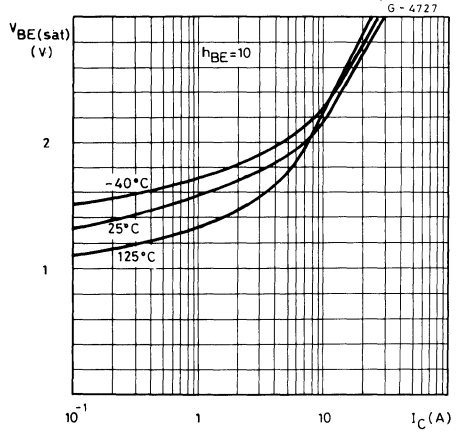

Base-emitter saturation voltage

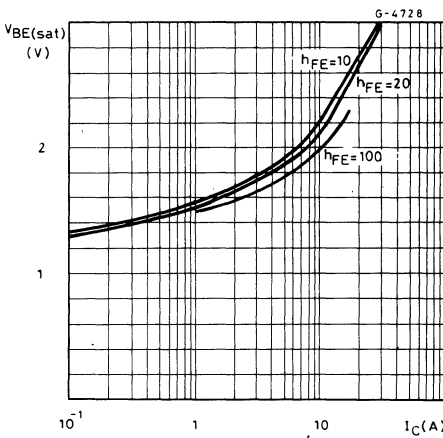

Collector-base capacitance

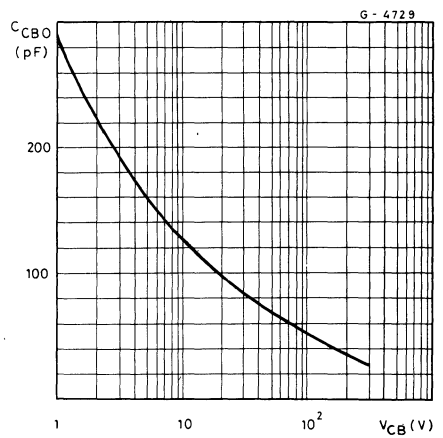

Forward voltage

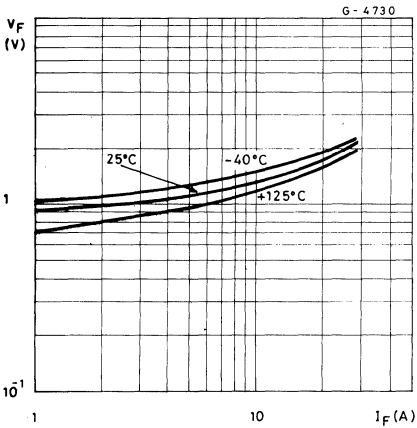

I_{CEV} Temperature

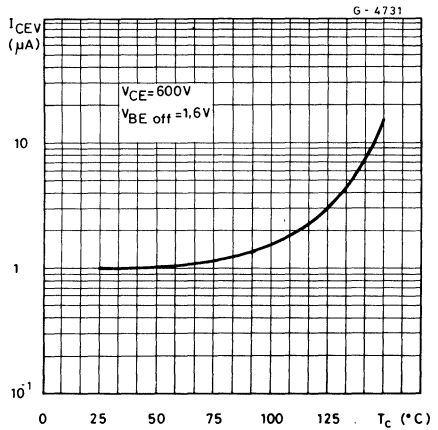

Saturated switching characteristics (resistive)

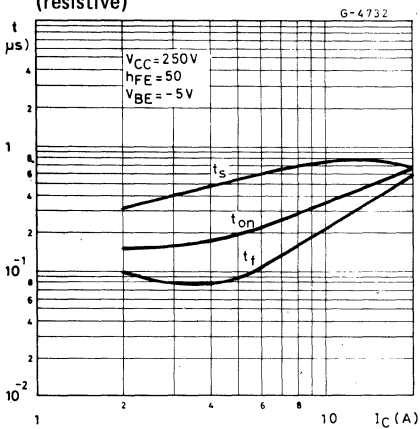

Saturated switching characteristics (inductive)

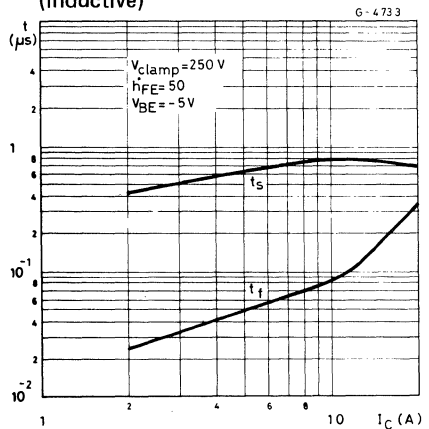

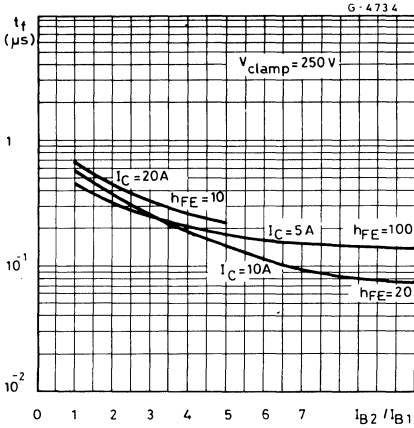
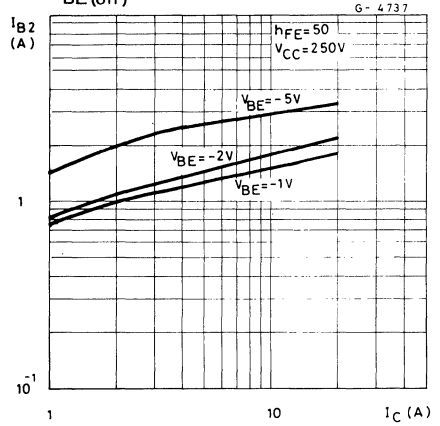
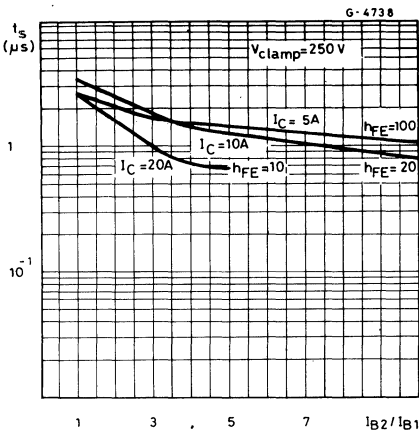
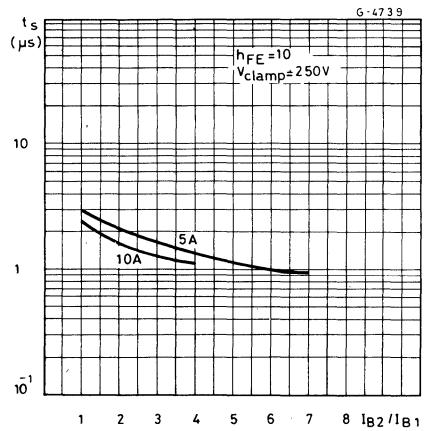
Fall time (resistive)

Reverse base current vs. I_C and V_{BE} (off)

Storage time (inductive)

Storage time (inductive)

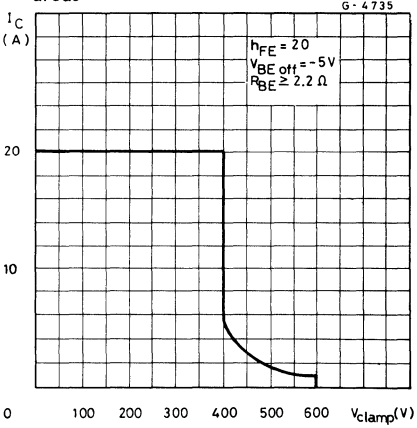

BUT13P

Clamped reverse bias safe operating areas



Safe operating areas

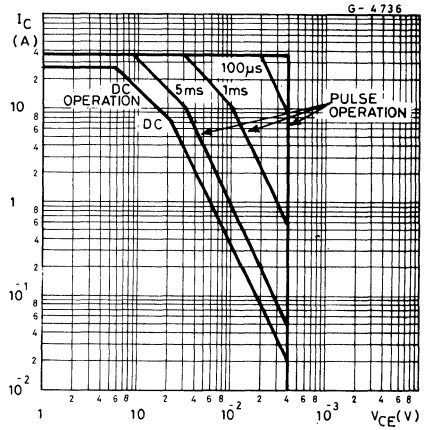

Thermal transient response

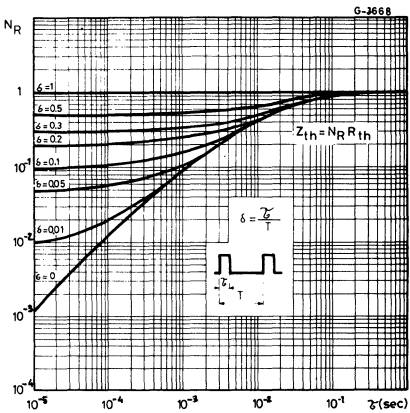

MULTIEPITAXIAL PLANAR NPN



HIGH CURRENT POWER SWITCH

The BUV20, BUV21 and BUV22 are silicon multi-epitaxial planar NPN transistor in Jeced TO-3 metal case, intended for use in switching and linear applications in military and industrial equipment.

ABSOLUTE MAXIMUM RATINGS

		BUV20	BUV21	BUV22
V_{CBO}	Collector-base voltage ($I_E = 0$)	160V	250V	300V
V_{CER}	Collector-emitter voltage ($R_{BE} = 100\Omega$)	150V	240V	290V
V_{CEX}	Collector-emitter voltage ($V_{BE} = -1.5V$)	160V	250V	300V
V_{CEO}	Collector-emitter voltage ($I_B = 0$)	125V	200V	250V
V_{EBO}	Emitter-base voltage ($I_C = 0$)	7V	7V	7V
I_C	Collector current	50A	40A	40A
I_{CM}	Collector peak current	60A	50A	50A
I_B	Base current	10A	8A	8A
P_{tot}	Total power dissipation at $T_{case} \leq 25^\circ C$		250W	
T_{stg}	Storage temperature		-65 to 200°C	
T_j	Junction temperature		200°C	

INTERNAL SCHEMATIC DIAGRAM

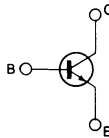

MECHANICAL DATA

Dimensions in mm

Collector connected to case

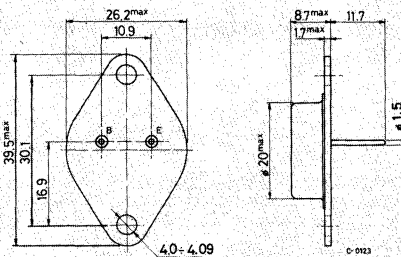

TO-3



BUV20
BUV21
BUV22

THERMAL DATA

$R_{th\ j-case}$	Thermal resistance junction-case	max. 0.7 °C/W
------------------	----------------------------------	---------------

ELECTRICAL CHARACTERISTICS ($T_{case} = 25^{\circ}C$ unless otherwise specified)

Parameter	Test conditions	Min.	Typ.	Max.	Unit
I_{CEO} Collector cutoff current ($I_B = 0$)	for BUV20 $V_{CE} = 100V$ for BUV21 $V_{CE} = 160V$ for BUV22 $V_{CE} = 200V$			3 3 3	mA mA mA
I_{CEX} Collector cutoff current ($V_{BE} = -1.5A$)	$V_{CE} = V_{CEX}$ for BUV20 for BUV21 for BUV22 at $T_{case} = 125^{\circ}C$ for BUV20 for BUV21 for BUV22			3 3 3 12 12 12	mA mA mA mA mA mA
I_{EBO} Emitter cutoff current ($I_C = 0$)	$V_{EB} = 5V$			1	mA
$V_{CEO(sus)}$ * Collector-emitter sustaining voltage ($I_B = 0$)	$I_C = 200mA$ $L = 25mH$ for BUV20 for BUV21 for BUV22			125 200 250	V V V
$V_{(BR)EBO}$ * Emitter-base breakdown voltage ($I_C = 0$)	$I_E = 50mA$			7	V
$V_{CE(sat)}$ * Collector-emitter saturation voltage	for BUV20 $I_C = 25A$ $I_B = 2.5A$ $I_C = 50A$ $I_B = 5A$ for BUV21 $I_C = 12A$ $I_B = 1.2A$ $I_C = 25A$ $I_B = 3A$ for BUV22 $I_C = 10A$ $I_B = 1A$ $I_C = 20A$ $I_B = 2.5A$			0.3 0.6 0.7 1.2 0.2 0.6 0.9 1.5 0.2 1 0.5 1.5	V V V V V V
$V_{BE(sat)}$ * Base-emitter saturation voltage	for BUV20 $I_C = 50A$ $I_B = 5A$ for BUV21 $I_C = 25A$ $I_B = 3A$ for BUV22 $I_C = 40A$ $I_B = 4A$			1.4 2 1.2 1.5 1.2 1.5	V V V



BUV20
BUV21
BUV22

ELECTRICAL CHARACTERISTICS (continued)

Parameter	Test conditions	Min.	Typ.	Max.	Unit
h_{FE}^* DC current gain	for BUV20 $V_{CE} = 2V$ $I_C = 25A$ $V_{CE} = 4V$ $I_C = 50A$ for BUV21 $V_{CE} = 2V$ $I_C = 12A$ $V_{CE} = 4V$ $I_B = 25A$ for BUV22 $V_{CE} = 4V$ $I_C = 10A$ $V_{CE} = 4V$ $I_C = 20A$	20 10	60	— —	— —
f_T Transition frequency	$V_{CE} = 15V$ $I_C = 2A$ $f = 10MHz$	8			MHz
t_{on} Turn-on time	for BUV20 $I_C = 50A$ $I_B = 5A$ for BUV21 $I_C = 25A$ $I_B = 3A$ for BUV22 $I_C = 20A$ $I_B = 2.5A$			1.5 1.2 1.3	μs μs μs
t_f Fall time	for BUV20 $I_C = 50A$ $I_{B1} = -I_{B2} = 5A$ for BUV21 $I_C = 25A$ $I_{B1} = -I_{B2} = 3A$ for BUV22 $I_C = 20A$ $I_{B1} = -I_{B2} = 2.5A$			0.3 0.4 0.5	μs μs μs
t_s Storage time	for BUV20 $I_C = 50A$ $I_{B1} = -I_{B2} = 5A$ for BUV21 $I_C = 25A$ $I_{B1} = -I_{B2} = 3A$ for BUV22 $I_C = 20A$ $I_{B1} = -I_{B2} = 2.5A$			1.2 1.8 2	μs μs μs

* Pulsed. pulse duration = 300 μs , duty cycle $\leq 2\%$.



BUV23
BUV24
BUV25

MULTIEPITAXIAL MESA NPN

POWER SWITCH

The BUV23, BUV24 and BUV25 are silicon multiepitaxial mesa NPN transistors in Jedec TO-3 metal case, intended for use in power switching applications in military and industrial equipments.

ABSOLUTE MAXIMUM RATINGS

		BUV23	BUV24	BUV25
V_{CBO}	Collector-base voltage ($I_E = 0$)	400V	450V	500V
V_{CER}	Collector-emitter voltage ($R_{BE} = 100\Omega$)	390V	440V	500V
V_{CEX}	Collector-emitter voltage ($V_{BE} = -1.5V$)	400V	450V	500V
V_{CEO}	Collector-emitter voltage ($I_B = 0$)	325V	400V	500V
V_{EBO}	Emitter-base voltage ($I_C = 0$)	7V	7V	7V
I_C	Collector current	30A	20A	15A
I_{CM}	Collector peak current ($t_p = 10ms.$)	40A	30A	20A
I_B	Base current	6A	4A	3A
P_{tot}	Total power dissipation at $T_{case} \leq 25^\circ C$		250W	
T_{stg}	Storage temperature		-65 to 200°C	
T_j	Junction temperature		200°C	

INTERNAL SCHEMATIC DIAGRAM

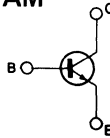

MECHANICAL DATA

Dimensions in mm

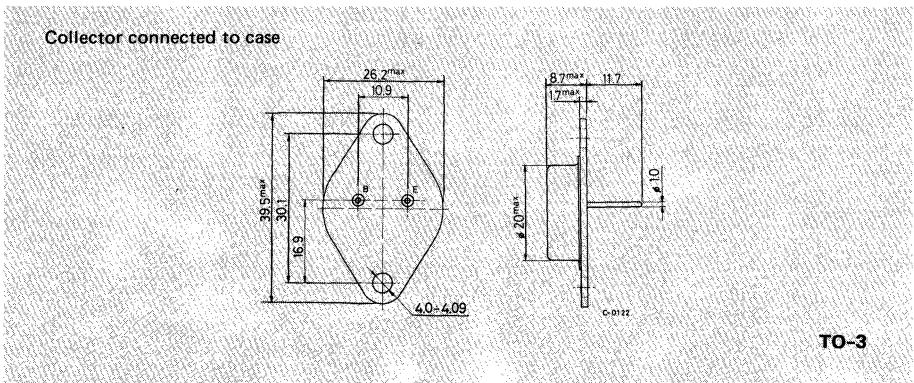



THERMAL DATA

$R_{th\ j-case}$ Thermal resistance junction-case	max. 0.7 °C/W
---	---------------

ELECTRICAL CHARACTERISTICS ($T_{case} = 25^{\circ}C$ unless otherwise specified)

Parameter	Test conditions	Min.	Typ.	Max.	Unit
I_{CEO} Collector cutoff current ($I_B = 0$)	$V_{CE} = 260V$ for BUV23 $V_{CE} = 320V$ for BUV24 $V_{CE} = 400V$ for BUV25			3 3 3	 mA mA mA
I_{CEX} Collector cutoff current ($V_{BE} = -1.5V$)	$V_{CE} = V_{CEX}$ $T_{case} = 125^{\circ}C$ $V_{CE} = V_{CEX}$			3 12	 mA mA
I_{EBO} Emitter cutoff current ($I_C = 0$)	$V_{EB} = 5V$			1	mA
$V_{CE(sat)}$ * Collector-emitter saturation voltage	for BUV23 $I_C = 8A$ $I_B = 1.6A$ $I_C = 16A$ $I_B = 3.2A$ for BUV24 $I_C = 6A$ $I_B = 1.2A$ $I_C = 12A$ $I_B = 2.4A$ for BUV25 $I_C = 4A$ $I_B = 0.8A$ $I_C = 8A$ $I_B = 1.6A$			0.2 0.35 0.15 0.3 0.2 0.6	0.8 1 0.6 1 0.6 1 V V V V V V
$V_{BE(sat)}$ * Base-emitter saturation voltage	for BUV23 $I_C = 16A$ $I_B = 3.2A$ for BUV24 $I_C = 12A$ $I_B = 2.4A$ for BUV25 $I_C = 8A$ $I_B = 1.6A$			1.15 1 1.2	1.5 1.15 1.5 V V V
$V_{CEO(sus)}$ * Collector-emitter sustaining voltage	$I_C = 200mA$ $L = 25mH$ for BUV23 for BUV24 for BUV25			325 400 500	 V V V
$V_{(BR)EBO}$ * Emitter-base breakdown voltage ($I_C = 0$)	$I_E = 50mA$			7	V
h_{FE} * DC current gain	$V_{CE} = 4V$ for BUV23 $I_C = 8A$ $I_C = 16A$ $V_{CE} = 4V$ for BUV24 $I_C = 6A$ $I_C = 12A$ $V_{CE} = 4V$ for BUV25 $I_C = 4A$ $I_C = 8A$			15 8 15 8 15 8	60 — 60 — 60 — —



BUV23
BUV24
BUV25

ELECTRICAL CHARACTERISTICS (continued)

Parameter	Test conditions	Min.	Typ.	Max.	Unit
f_T Transition frequency	$V_{CE} = 15V$ $I_C = 2A$ $f = 10MHz$	8			MHz
t_{on} Turn-on time	for BUV23 $I_C = 16A$ $I_B = 3.2A$ for BUV24 $I_C = 12A$ $I_B = 2.4A$ for BUV25 $I_C = 8A$ $I_B = 1.6A$	0.55	1.3		μs
t_f Fall time	for BUV23 $I_C = 16A; I_{B1} = -I_{B2} = 3.2A$ for BUV24 $I_C = 12A; I_{B1} = -I_{B2} = 2.4A$ for BUV25 $I_C = 8A; I_{B1} = -I_{B2} = 1.6A$	0.26	1.2		μs
t_s Storage time	for BUV23 $I_C = 16A; I_{B1} = -I_{B2} = 3.2A$ for BUV24 $I_C = 12A; I_{B1} = -I_{B2} = 2.4A$ for BUV25 $I_C = 8A; I_{B1} = -I_{B2} = 1.6A$	1.7	2.5		μs
		1.5	3		μs
		3.5	5		μs

* Pulsed: pulse duration = 300 μs , duty cycle $\leq 2\%$.

MULTIEPITAXIAL MESA NPN

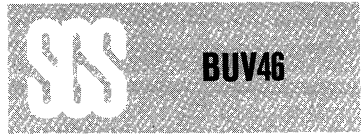

HIGH VOLTAGE POWER SWITCH

The BUV46 is a silicon multiepitaxial mesa NPN transistor in **Jedec TO-220** plastic package, intended for high voltage, fast switching applications.

ABSOLUTE MAXIMUM RATINGS

V_{CES}	Collector-emitter voltage ($V_{BE} = 0$)	850	V
V_{CEX}	Collector-emitter voltage ($V_{BE} = -2.5V$)	850	V
V_{CEO}	Collector-emitter voltage ($I_B = 0$)	400	V
V_{EBO}	Emitter-base voltage ($I_C = 0$)	7	V
I_C	Collector current	5	A
I_B	Base current	3	A
P_{tot}	Total power dissipation at $T_{case} \leq 25^\circ C$	85	W
T_{stg}	Storage temperature	-65 to 175	$^\circ C$
T_j	Junction temperature	175	$^\circ C$

INTERNAL SCHEMATIC DIAGRAM

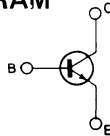

MECHANICAL DATA

Dimensions in mm

Collector connected to tab.

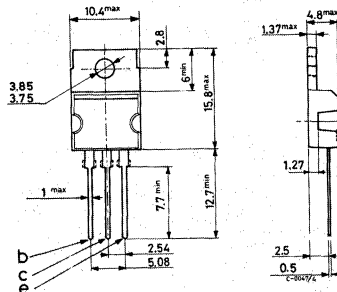

TO-220

**BUV46****THERMAL DATA**

$R_{th\ j-case}$	Thermal resistance junction-case	max. 1.76 °C/W
------------------	----------------------------------	----------------

ELECTRICAL CHARACTERISTICS ($T_{case} = 25^{\circ}C$ unless otherwise specified)

Parameter	Test conditions	Min.	Typ.	Max.	Unit
I_{CES} Collector cutoff current ($V_{BE} = 0$)	$V_{CE} = 850V$ $V_{CE} = 850V$ $T_{case} = 125^{\circ}C$			100 1	μA mA
I_{CER} Collector cutoff current ($R_{BE} = 10\Omega$)	$V_{CE} = 850V$ $V_{CE} = 850V$ $T_{case} = 125^{\circ}C$			300 2	μA mA
I_{EBO} Emitter cutoff current ($I_C = 0$)	$V_{EB} = 7V$			1	mA
$V_{CEO(sus)}$ * Collector-emitter sustaining voltage	$I_C = 100mA$	400			V
$V_{CE(sat)}$ * Collector-emitter saturation voltage	$I_C = 2.5A$ $I_B = 0.5A$ $I_C = 3.5A$ $I_B = 0.7A$			1.5 5	V V
$V_{BE(sat)}$ * Base-emitter saturation voltage	$I_C = 2.5A$ $I_B = 0.5A$			1.3	V
t_{on} Turn-time				1	μs
t_s Storage time	$I_C = 2.5A$ $V_{CC} = 150V$ $I_{B1} = -I_{B2} = 0.5A$			3	μs
t_f Fall time				0.8	μs

* Pulsed: pulse duration = 300 μs , duty cycle = 2%.

MULTIEPITAXIAL MESA NPN



HIGH VOLTAGE POWER SWITCH

The BUV47 is silicon multi-epitaxial mesa NPN transistor in SOT-93 plastic package. It is intended for high voltage, fast switching and industrial applications.

ABSOLUTE MAXIMUM RATINGS

	BUV47	BUV47A
V_{CBO}	850V	1000V
V_{CEO}	400V	450V
V_{EBO}		7V
I_C		9A
I_{CM}		15A
I_B		3A
I_{BM}		6A
P_{tot}		120W
T_{stg}		-65 to 175°C
T_j		175°C

INTERNAL SCHEMATIC DIAGRAM

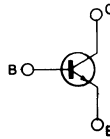

MECHANICAL DATA

Dimensions in mm

Collector connected to tab.

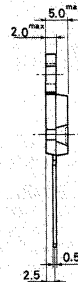
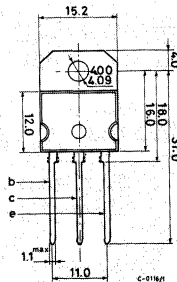

(sim. to TO-218) SOT-93



BUV47
BUV47A

THERMAL DATA

$R_{th\ j-case}$ Thermal resistance junction-case	max. 1.25 °C/W
---	----------------

ELECTRICAL CHARACTERISTICS ($T_{case} = 25^{\circ}C$ unless otherwise specified)

Parameter	Test conditions	Min.	Typ.	Max.	Unit
I_{CEX} Collector cutoff current ($V_{BE} = -2.5V$)	$V_{CE} = V_{CBO}$ $V_{CE} = V_{CBO}$ $T_{case} = 125^{\circ}C$			0.15 1.5	mA mA
I_{CER} Collector cutoff current ($R_{BE} = 10\Omega$)	$V_{CE} = V_{CBO}$ $V_{CE} = V_{CBO}$ $T_{case} = 125^{\circ}C$			0.4 3	mA mA
I_{EBO} Emitter cutoff current ($I_C = 0$)	$V_{EB} = 5V$			1	mA
V_{EBO} Emitter-base voltage ($I_C = 0$)	$I_E = 0.05A$	7		30	mA
$V_{CEO(sus)}$ * Collector-emitter sustaining voltage ($I_B = 0$)	$I_C = 0.2A$ $L = 25mH$ for BUV47A	400			V V
$V_{CE(sat)}$ * Collector-emitter saturation voltage	$I_C = 5A$ $I_B = 1A$ $I_C = 8A$ $I_B = 2.5A$			1.5 3	V V
$V_{BE(sat)}$ * Base-emitter saturation voltage	$I_C = 5A$ $I_B = 1A$			1.6	V



ELECTRICAL CHARACTERISTICS (continued)

Parameter	Test conditions	Min.	Typ.	Max.	Unit
t_{on} Turn-on time	Resistive load $I_C = 5A$ $I_{B1} = 1A$ $I_{B2} = -1A$ $V_{CC} = 150V$			1	μs
t_s Storage time				3	μs
t_f Fall time				0.8	μs
t_f Fall time	Inductive load $I_C = 5A$ $I_{B1} = 1A$ $V_{BE} = -5V$ $V_{CC} = 300V$ $L = 3\mu H$ $T_j = 100^\circ C$			0.5	μs

* Pulsed: pulse duration = 300 μs , duty cycle = 1.5%.

Safe operating areas

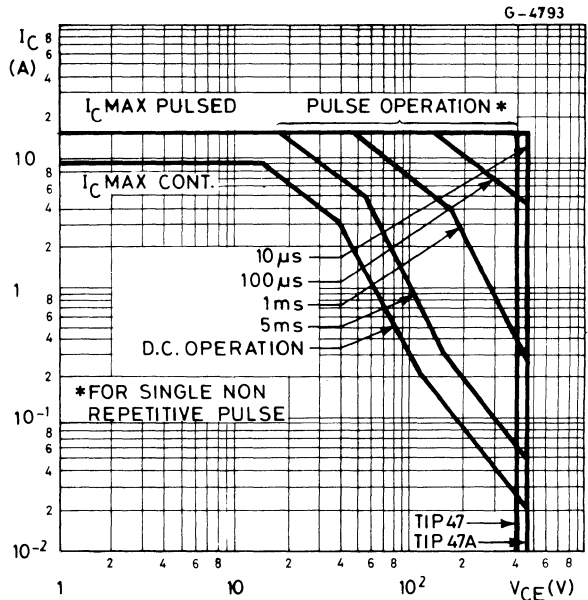



BUV48
BUV48A

MULTIEPITAXIAL MESA NPN

HIGH VOLTAGE FAST SWITCHING

The BUV48 is silicon multiepitaxial mesa NPN transistor in SOT-93 plastic package. It is intended for high voltage, high current, fast switching and industrial applications.

ABSOLUTE MAXIMUM RATINGS

	BUV48	BIV48A
V_{CBO}	850V	1000V
V_{CEO}	400V	450V
V_{EBO}		7V
I_C		15A
I_{CM}		30A
I_B		4A
I_{BM}		20A
P_{tot}		150W
T_{stg}		175°C
T_j		-65 to 175°C

INTERNAL SCHEMATIC DIAGRAM

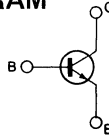

MECHANICAL DATA

Dimensions in mm

Collector connected to tab.

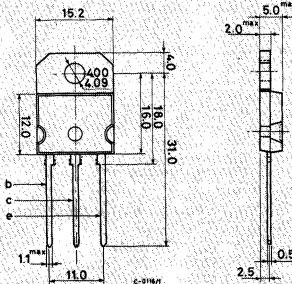

(sim. to TO-218) SOT-93



THERMAL DATA

$R_{th\ j-case}$	Thermal resistance junction-case	max.	1	°C/W
------------------	----------------------------------	------	---	------

ELECTRICAL CHARACTERISTICS ($T_{case} = 25^{\circ}C$ unless otherwise specified)

Parameter	Test conditions	Min.	Typ.	Max.	Unit
I_{CEX}	Collector cutoff current ($V_{BE} = 2.5V$) $V_{CE} = V_{CBO}$ $V_{CE} = V_{CBO}$ $T_{case} = 125^{\circ}C$			0.2 2	mA mA
I_{EBO}	Emitter cutoff current ($I_C = 0$) $V_{EB} = 5V$			1	mA
I_{CER}	Collector cutoff current ($R_{BE} = 10\Omega$) $V_{CE} = V_{CBO}$ $V_{CE} = V_{CBO}$ $T_{case} = 125^{\circ}C$			0.5 4	mA mA
$V_{CEO(sus)}$ *	Collector-emitter sustaining voltage ($I_B = 0$) $I_C = 200mA$ $L = 25mH$ for BUV48 for BUV48A	400 450			V V
V_{EBO}	Emitter-base voltage ($I_C = 0$) $I_E = 0.05A$	7		30	V
$V_{CE(sat)}$ *	Collector-emitter saturation voltage $I_C = 10A$ $I_B = 2A$ for BUV48 $I_C = 8A$ $I_B = 1.6A$ for BUV48A $I_C = 15A$ $I_B = 3A$ for BUV48 $I_C = 12A$ $I_B = 2.4A$ for BUV48A			1.5 1.5 5 5	V V V V
$V_{BE(sat)}$ *	Base-emitter saturation voltage $I_C = 10A$ $I_B = 2A$ for BUV48 $I_C = 8A$ $I_B = 1.6A$ for BUV48A			1.6 1.6	V V
t_{on}	Turn-on time $V_{CC} = 150V$ $V_{BE} = -6V$ $R_{B2} = 1.5; I_C = 10A$ (BUV48)	0.55	1		μs
t_s	Storage time $I_C = 8A$ (BUV48A)	1.5	3		μs
t_f	Fall time $I_{B1} = -I_{B2} = 2A$ (BUV48) $I_{B1} = -I_{B2} = 1.6A$ (BUV48A)	0.3	0.8		μs

* Pulsed: pulse duration = 300 μs duty cycle = 1.5%.



BUW11

MULTIEPITAXIAL MESA NPN

HIGH VOLTAGE POWER SWITCH

The BUW11 is silicon multiepitaxial mesa NPN transistors in SOT-93 plastic package. It is intended for high voltage, fast switching industrial applications.

ABSOLUTE MAXIMUM RATINGS

V_{CES}	Collector-emitter voltage ($V_{BE} = 0$)	850	V
V_{CEO}	Collector-emitter voltage ($I_B = 0$)	400	V
I_C	Collector current	5	A
I_{CM}	Collector peak current ($t_p \leq 2$ ms.)	10	A
I_B	Base current	2	A
I_{BM}	Base peak current ($t_p \leq 2$ ms.)	3	A
P_{tot}	Total power dissipation at $T_{case} \leq 25^\circ\text{C}$	100	W
T_{stg}	Storage temperature	-65 to 175	$^\circ\text{C}$
T_j	Junction temperature	175	$^\circ\text{C}$

INTERNAL SCHEMATIC DIAGRAM

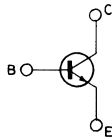

MECHANICAL DATA

Dimensions in mm

Collector connected to tab.

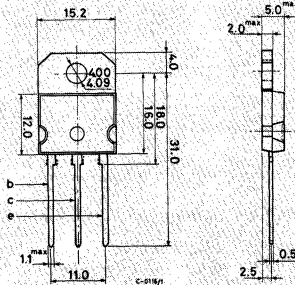

(sim. to TO-218) SOT-93

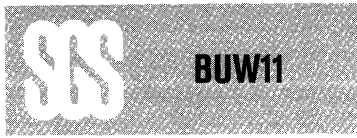

THERMAL DATA

$R_{th\ j-case}$	Thermal resistance junction-case	max.	1.5	°C/W
------------------	----------------------------------	------	-----	------

ELECTRICAL CHARACTERISTICS ($T_{case} = 25^{\circ}C$ unless otherwise specified)

Parameter	Test conditions	Min.	Typ.	Max.	Unit
I_{CES} Collector cutoff current ($V_{BE} = 0$)	$V_{CE} = 850V$			1	mA
	$V_{CE} = 850V$ $T_j = 125^{\circ}C$			2	mA
I_{EBO} Emitter cutoff current ($I_C = 0$)	$V_{EB} = 9V$			10	mA
$V_{CEO(sus)}$ * Collector-emitter sustaining voltage	$I_C = 100mA$ $L = 25mH$	400			V
$V_{CE(sat)}$ * Collector-emitter saturation voltage	$I_C = 3A$ $I_B = 0.6A$			1.5	V
$V_{BE(sat)}$ * Base-emitter saturation voltage	$I_C = 3A$ $I_B = 0.6A$			1.4	V
t_{on} Turn-on time	$I_C = 3A$ $I_{B1} = 0.6A$ $I_{B2} = -0.6A$			1	μs
t_s Storage time				4	μs
t_f Fall time				0.8	μs

* Pulsed: pulse duration = 300 μs , duty cycle = 1.5%.



BUW11

Safe operating areas

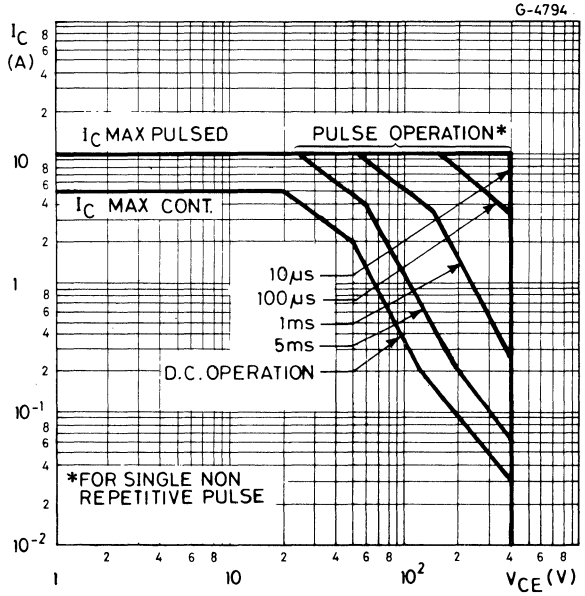

MULTIEPITAXIAL MESA NPN

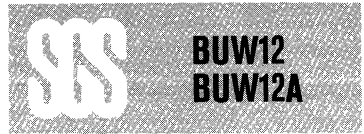

HIGH VOLTAGE POWER SWITCH

The BUW12 and BUW12A are silicon multiepitaxial mesa NPN transistors in SOT-93 plastic package, particularly intended for high voltage, fast switching industrial applications.

ABSOLUTE MAXIMUM RATING

		BUW12	BUW12A
V_{CES}	Collector-emitter voltage ($V_{BE} = 0$)	850V	1000V
V_{CEO}	Collector-emitter voltage ($I_B = 0$)	400V	450V
I_C	Collector current		8A
I_{CM}	Collector peak current ($t_p \leq 2ms$)		20A
I_B	Base current		4A
I_{BM}	Base peak current ($t_p \leq 2ms$)		6A
P_{tot}	Total power dissipation at $T_{case} \leq 25^\circ C$		125W
T_{stg}	Storage temperature	-65 to 175°C	
T_j	Junction temperature	175°C	

INTERNAL SCHEMATIC DIAGRAM

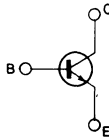

MECHANICAL DATA

Dimensions in mm

Collector connected to tab.

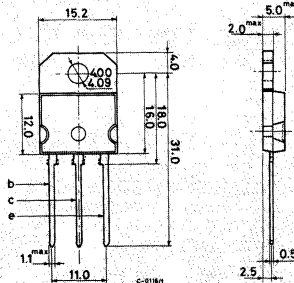

(sim. to TO-218) SOT-93

THERMAL DATA

$R_{th\ j-case}$	Thermal resistance junction-case	max. 1.2 °C/W
------------------	----------------------------------	---------------

ELECTRICAL CHARACTERISTICS ($T_{case} = 25^{\circ}C$ unless otherwise specified)

Parameter		Test conditions	Min.	Typ.	Max.	Unit
I_{CES}	Collector cutoff current ($V_{BE} = 0$)	$V_{CE} = V_{CES}$			1	mA
		$V_{CE} = V_{CES}$ $T_j = 125^{\circ}C$			3	mA
I_{EBO}	Emitter cutoff current ($I_C = 0$)	$V_{EB} = 9V$			10	mA
$V_{CEO(sus)}$ *	Collector-emitter sustaining voltage	$I_C = 100mA$ $L = 25mH$	400			V
$V_{CE(sat)}$ *	Collector-emitter saturation voltage	$I_C = 6A$ $I_B = 1.2A$			1.5	V
$V_{BE(sat)}$ *	Base emitter saturation voltage	$I_C = 6A$ $I_B = 1.2A$			1.5	V
t_{on}	Turn-on time	$I_C = 6A$ $I_{B1} = 1.2A$ $I_{B2} = 1.2A$			1	μs
t_s	Storage time				4	μs
t_f	Fall time				0.8	μs

* Pulsed: pulse duration = 300 μs , duty cycle = 1.5%.

G - 4795

Safe operating areas

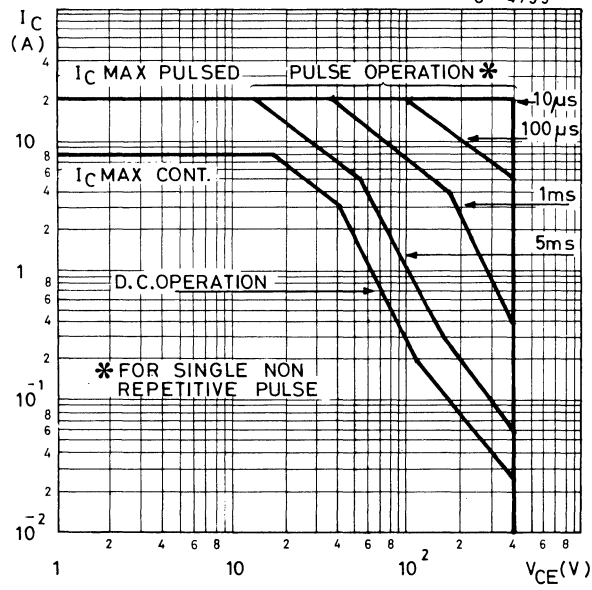

MULTIEPITAXIAL MESA PNP

HIGH VOLTAGE POWER SWITCH

The BUW 32 is a silicon multiepitaxial mesa PNP transistor in Jedec TO-3 metal case. It is intended for high voltage, fast switching and industrial applications. The complementary NPN type is the BUW 35.

ABSOLUTE MAXIMUM RATINGS

V_{CES}	Collector-emitter voltage ($V_{BE}=0$)	-450	V
V_{CEO}	Collector-emitter voltage ($I_B=0$)	-400	V
V_{EBO}	Emitter-base voltage ($I_C=0$)	-7	V
I_C	Collector current	-10	A
I_B	Base current	-5	A
P_{tot}	Total power dissipation at $T_{case} \leq 25^\circ\text{C}$	125	W
T_{stg}	Storage temperature	-65 to 200	$^\circ\text{C}$
T_j	Junction temperature	200	$^\circ\text{C}$

INTERNAL SCHEMATIC DIAGRAM

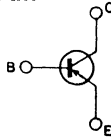

MECHANICAL DATA

Dimensions in mm

Collector connected to case

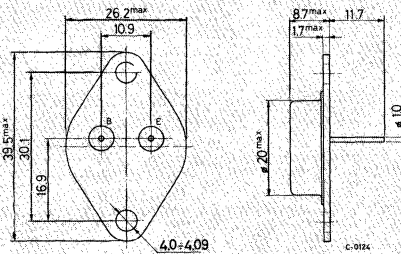

TO-3

**THERMAL DATA**

$R_{th\ j-case}$	Thermal resistance junction-case	max	1.4	°C/W
------------------	----------------------------------	-----	-----	------

ELECTRICAL CHARACTERISTICS ($T_{case} = 25^{\circ}C$ unless otherwise specified)

Parameter	Test conditions	Min.	Typ.	Max.	Unit
I_{CES}	Collector cutoff current ($V_{BE}=0$)	$V_{CE}=-450V$		-500	μA
I_{CES}	Collector cutoff current ($I_C=0$)	$V_{CE}=-450V$ $T_{case}=125^{\circ}C$		-3	mA
I_{EBO}	Emitter cutoff current ($I_C=0$)	$V_{EB}=-7V$		-1	mA
$V_{CEO(sus)}$	*Collector-emitter sustaining voltage ($I_B=0$)	$I_C = -100mA$		-400	V
$V_{CE(sat)}$	* Collector-emitter saturation voltage	$I_C = -5A$	$I_B = -1A$	-1.5	V
$V_{BE(sat)}$	* Base-emitter saturation voltage	$I_C = -5A$	$I_B = -1A$	-1.5	V
h_{FE}	* DC current gain	$I_C = -1A$	$V_{CE}=-5V$	15	—
t_{on}	Turn-on time	$I_C = -5A$ $V_{CC}=-250V$	$I_B = -1A$	0.75	μs
t_s	Storage time	$I_C = -5A$	$V_{CC}=-250V$	3	μs
t_f	Fall time	$I_{B1} = -1A$	$I_{B2} = 2A$	0.8	μs

* Pulsed: pulse duration = 300 μs , duty cycle = 1.5%



BUW32

Safe operating areas

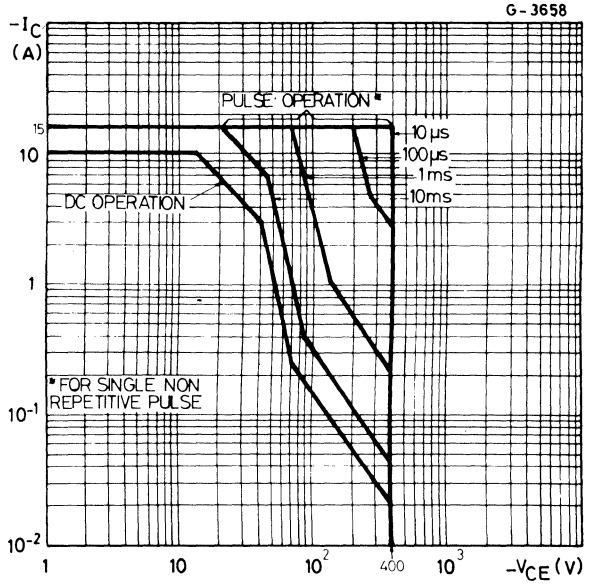

Derating curves

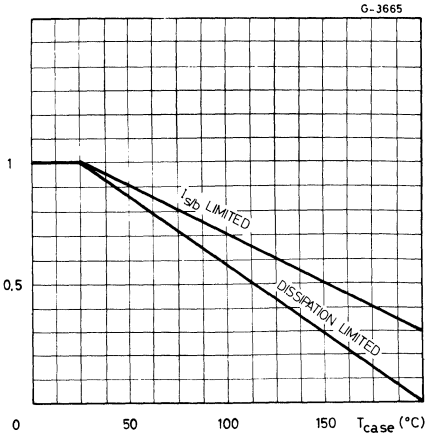

Transient thermal response

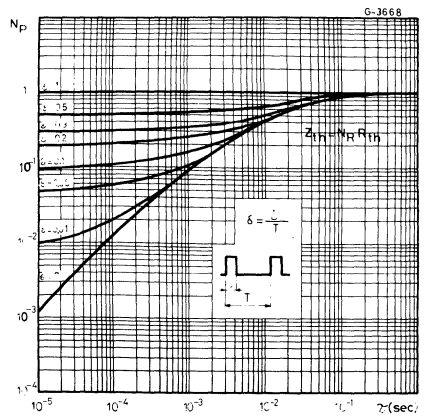



DC current gain

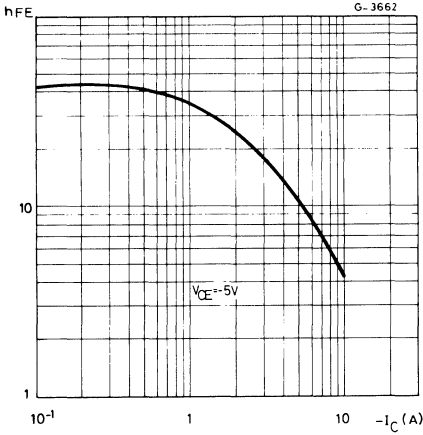

Collector-emitter saturation voltage

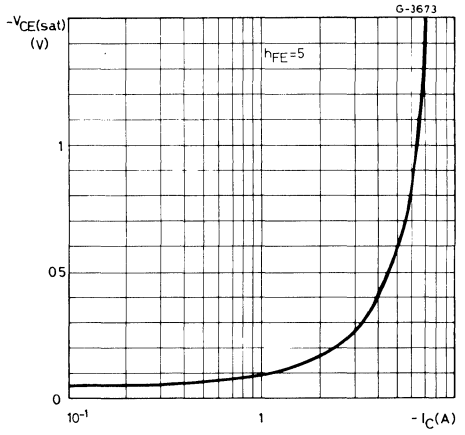

Collector-emitter saturation voltage

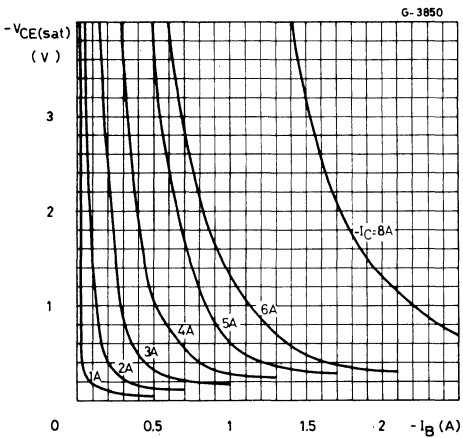

Base-emitter saturation voltage

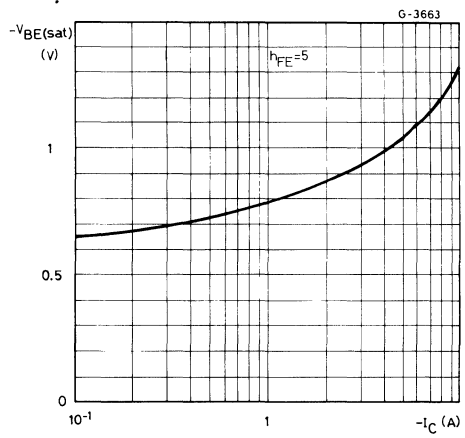

Saturated switching characteristics

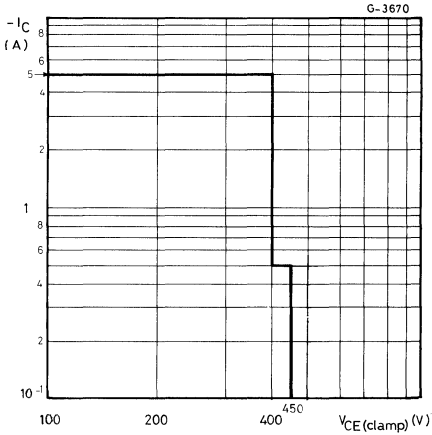

Clamped reverse bias safe operating areas

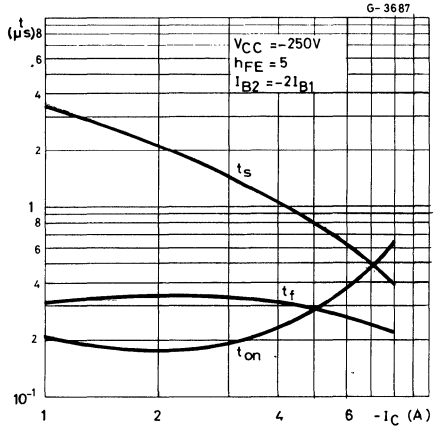

Clamped $E_{s/b}$ test circuit

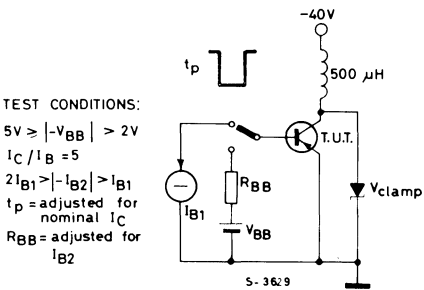

MULTIEPITAXIAL MESA NPN



HIGH VOLTAGE POWER SWITCH

The BUW 34, BUW 35 and BUW 36 are silicon multiepitaxial mesa NPN transistors in Jedec TO-3 metal case. They are intended for high voltage, fast switching applications.

ABSOLUTE MAXIMUM RATINGS

		BUW34	BUW35	BUW36
V_{CES}	Collector-emitter voltage ($V_{BE}=0$)	500V	800V	900V
V_{CEO}	Collector-emitter voltage ($I_B=0$)	400V	400V	450V
V_{EBO}	Emitter-base voltage ($I_C=0$)		7V	
I_C	Collector current		10A	
I_{CM}	Collector peak current		15A	
I_B	Base current		5A	
P_{tot}	Total power dissipation at $T_{case} \leq 25^\circ C$		125W	
T_{stg}	Storage temperature		-65 to 200°C	
T_j	Junction temperature		200°C	

INTERNAL SCHEMATIC DIAGRAM

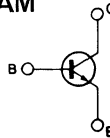

MECHANICAL DATA

Dimensions in mm

Collector connected to case

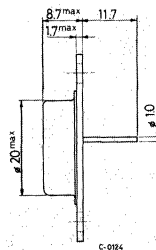
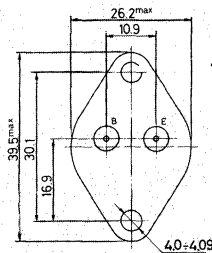

TO-3



BUW34
BUW35
BUW36

THERMAL DATA

$R_{th\ j-case}$	Thermal resistance junction-case	max 1.4 °C/W
------------------	----------------------------------	--------------

ELECTRICAL CHARACTERISTICS ($T_{case} = 25^{\circ}C$ unless otherwise specified)

Parameter	Test conditions	Min. Typ. Max.	Unit
I_{CES} Collector cutoff current ($V_{BE}=0$)	for BUW34 $V_{CE}=500V$ for BUW35 $V_{CE}=800V$ for BUW36 $V_{CE}=900V$ $T_{case}=125^{\circ}C$	500 500 500	μA μA μA
	for BUW34 $V_{CE}=500V$ for BUW35 $V_{CE}=800V$ for BUW36 $V_{CE}=900V$	3 3 3	mA mA mA
I_{EBO} Emitter cutoff current ($I_C=0$)	$V_{EB}=7V$	1	mA
$V_{CEO(sus)}$ *Collector-emitter sustaining voltage ($I_B=0$)	$I_C = 100mA$ for BUW34 for BUW35 for BUW36	400 400 450	V V V
$V_{CE(sat)}$ * Collector-emitter saturation voltage	All types $I_C = 5A$ $I_B = 1A$	1.5	V
	for BUW35 $I_C = 8A$ $I_B = 2.5A$ for BUW36 $I_C = 8A$ $I_B = 2.5A$	1.5 3	V V
$V_{BE(sat)}$ * Base-emitter saturation voltage	All types $I_C = 5A$ $I_B = 1A$	1.5	V
	for BUW35 $I_C = 8A$ $I_B = 2.5A$ for BUW36 $I_C = 8A$ $I_B = 2.5A$	1.8 1.8	V V
h_{FE} * DC current gain	$I_C = 1A$ $V_{CE}=5V$	15	—
t_{on} Turn-on time	$I_C = 5A$ $V_{CC}=250V$ $I_{B1} = 1A$	0.75	μs
t_s Storage time	$I_C = 5A$ $V_{CC}=250V$ $I_{B1} = 1A$	3	μs
t_f Fall time	$I_{B2} = -1A$	0.8	μs

* Pulsed: pulse duration = 300 μs , duty cycle = 1.5%

Safe operating areas

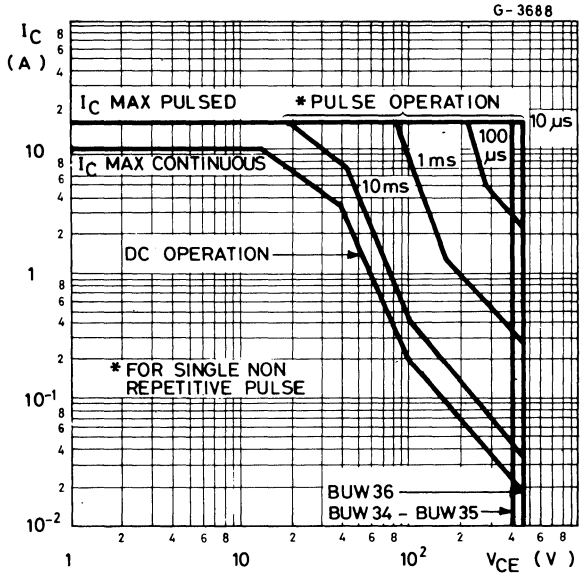

Derating curves

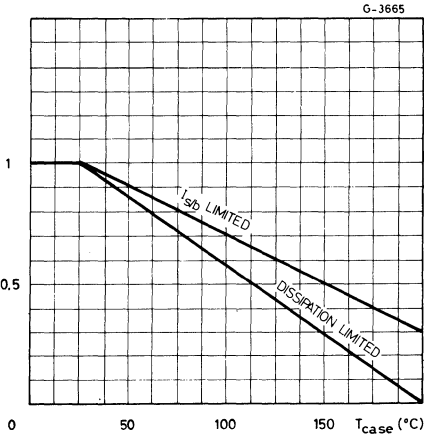

Transient thermal response

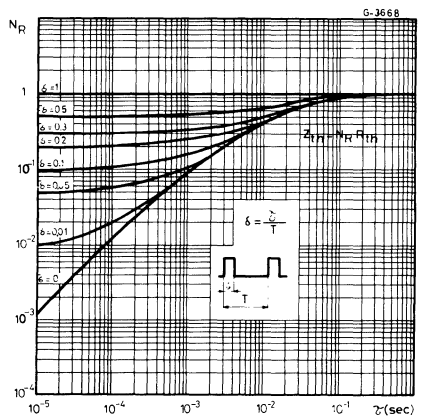

DC current gain

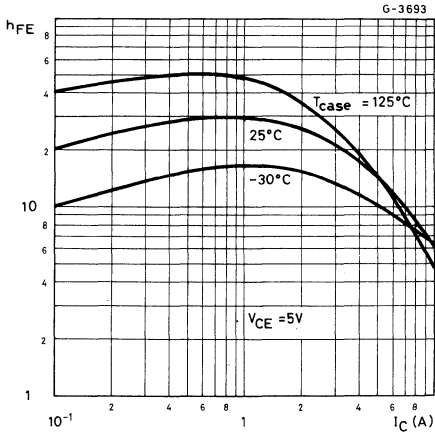

Collector-emitter saturation voltage

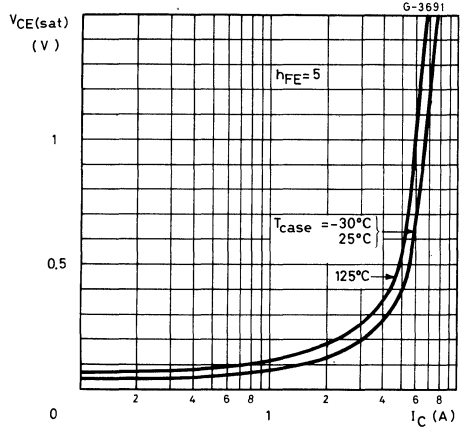

Collector-emitter saturation voltage

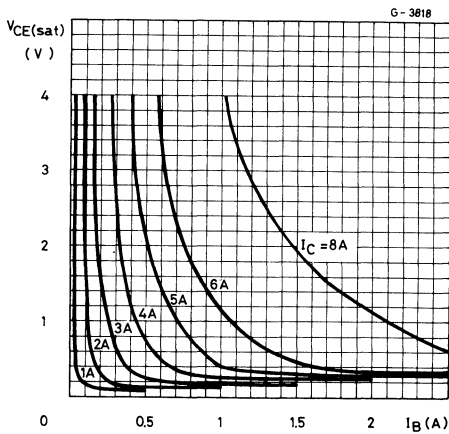

Base-emitter saturation voltage

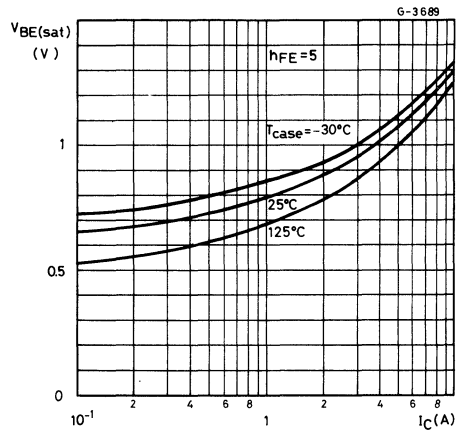

Saturated switching characteristics

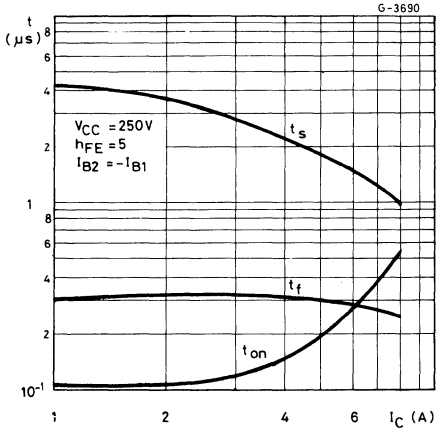

Saturated switching characteristics

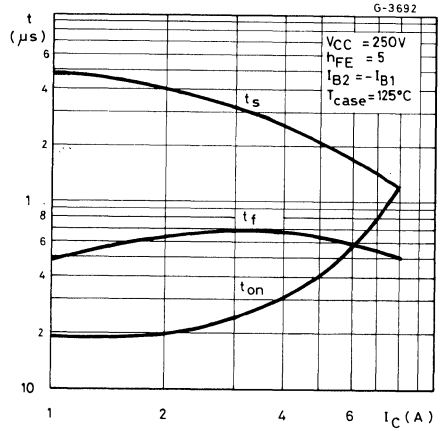

Clamped reverse bias safe operating areas

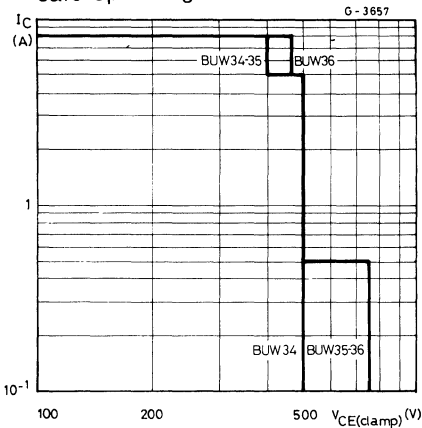

Clamped $E_{s/b}$ test circuit

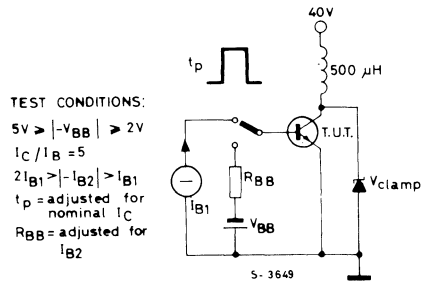



BUW42

MULTIEPITAXIAL MESA PNP

HIGH VOLTAGE POWER SWITCH

The BUW42 is a silicon multiepitaxial mesa PNP transistor in Jecdec TO-3 metal case, intended in fast switching applications for high output powers. The complementary NPN types are the 2N6547 and the BUX48.

ABSOLUTE MAXIMUM RATINGS

V_{CES}	Collector-emitter voltage ($V_{BE} = 0$)	-450	V
V_{CEO}	Collector-emitter voltage ($I_B = 0$)	-400	V
V_{EBO}	Emitter-base voltage ($I_C = 0$)	-7	V
I_C	Collector current	-15	A
I_{CM}	Collector peak current	-30	A
I_B	Base current	-10	A
P_{tot}	Total power dissipation $T_{case} \leq 25^\circ C$	150	W
T_{stg}	Storage temperature	-65 to 175	$^\circ C$
T_j	Junction temperature	175	$^\circ C$

INTERNAL SCHEMATIC DIAGRAM

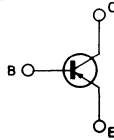

MECHANICAL DATA

Dimensions in mm

Collector connected to case

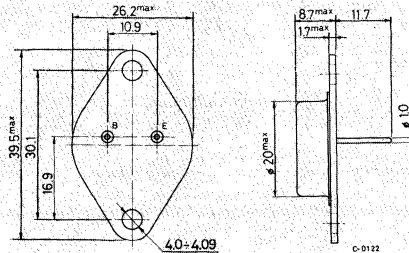

TO-3



THERMAL DATA

$R_{th\ j-case}$ Thermal resistance junction-case	max. 1 °C/W
---	-------------

ELECTRICAL CHARACTERISTICS ($T_{case} = 25^{\circ}C$ unless otherwise specified)

Parameter	Test conditions	Min.	Typ.	Max.	Unit
I_{CES} Collector cutoff current ($V_{BE} = 0$)	$V_{CE} = -450V$ $V_{CE} = -450V$ $T_{case} = 100^{\circ}C$			-1	mA
				-4	mA
I_{EBO} Emitter cutoff current ($I_C = 0$)	$V_{EB} = -7V$			-1	mA
$V_{CEO(sus)}$ Collector-emitter sustaining voltage ($I_B = 0$)	$I_C = -100mA$			-400	V
$V_{CE(sat)}$ * Collector-emitter saturation voltage	$I_C = -10A$ $I_B = -2A$ $I_C = -15A$ $I_B = -3A$ $T_{case} = 100^{\circ}C$ $I_C = -10A$ $I_B = -2A$			-1.5	V
				-5	V
				-2.5	V
$V_{BE(sat)}$ * Base-emitter saturation voltage	$I_C = -10A$ $I_B = -2A$ $T_{case} = 100^{\circ}C$ $I_C = -10A$ $I_B = -2A$			-1.6	V
				-1.6	V
h_{FE} * DC current gain	$I_C = -5A$ $V_{CE} = -2V$ $I_C = -10A$ $V_{CE} = -2V$		12	60	—
			6	30	—
t_{on} Turn-on time	Resistive load $V_{CC} = -250V$ $I_C = -10A$ $I_{B1} = -I_B = -2A$			1	μs
t_s Storage time				4	μs
t_f Fall time				0.7	μs

* Pulsed: pulse duration = 200 μs , duty cycle = 1.5%.



**BUW44
BUW45
BUW46**

MULTIEPITAXIAL MESA NPN

HIGH VOLTAGE, HIGH CURRENT POWER SWITCH

The BUW 44, BUW 45 and BUW 46 are multiepitaxial mesa NPN transistors in Jedec TO-3 metal case, intended in fast switching applications for high output powers.

ABSOLUTE MAXIMUM RATINGS

		BUW44	BUW45	BUW46
V_{CES}	Collector-emitter voltage ($V_{BE}=0$)	500V	800V	900V
V_{CEO}	Collector-emitter voltage ($I_B=0$)	400V	400V	450V
V_{EBO}	Emitter-base voltage ($I_C=0$)		7V	
I_C	Collector current		15A	
I_{CM}	Collector peak current		30A	
I_B	Base current		10A	
P_{tot}	Total power dissipation at $T_{case} \leq 25^\circ C$		175W	
T_{stg}	Storage temperature		-65 to 200°C	
T_j	Junction temperature		200°C	

INTERNAL SCHEMATIC DIAGRAM

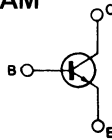

MECHANICAL DATA

Dimensions in mm

Collector connected to case

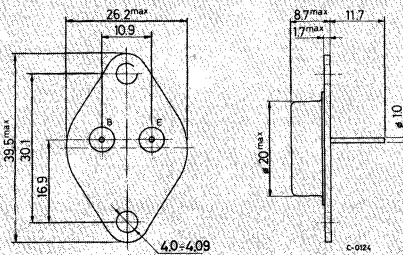

TO-3



THERMAL DATA

$R_{th\ j-case}$	Thermal resistance junction-case	max 1	$^{\circ}C/W$
------------------	----------------------------------	-------	---------------

ELECTRICAL CHARACTERISTICS ($T_{case} = 25^{\circ}C$ unless otherwise specified)

Parameter	Test conditions	Min. Typ. Max.	Unit
I_{CES} Collector cutoff current ($V_{BE} = 0$)	for BUW44 $V_{CE} = 500V$ for BUW45 $V_{CE} = 800V$ for BUW46 $V_{CE} = 900V$ $T_{case} = 125^{\circ}C$ for BUW44 $V_{CE} = 500V$ for BUW45 $V_{CE} = 800V$ for BUW46 $V_{CE} = 900V$	500 500 500 3 3 3	μA μA μA mA mA mA
I_{EBO} Emitter cutoff current ($I_C = 0$)	$V_{EB} = 7V$	1	mA
$V_{CEO(sus)}$ *Collector-emitter sustaining voltage	$I_C = 100mA$ for BUW44 for BUW45 for BUW46	400 400 450	V V V
$V_{CE(sat)}$ * Collector-emitter saturation voltage	for BUW44 $I_C = 10A$ $I_B = 2A$ $I_C = 6A$ $I_B = 1A$ for BUW45 and BUW46 $I_C = 10A$ $I_B = 2A$ $I_C = 7A$ $I_B = 1A$	3 1.5 1.5 1.5	V V V V
$V_{BE(sat)}$ * Base-emitter saturation voltage	for BUW44 $I_C = 10A$ $I_B = 2A$ $I_C = 6A$ $I_B = 1A$ for BUW45 and BUW46 $I_C = 10A$ $I_B = 2A$ $I_C = 7A$ $I_B = 1A$	1.8 1.4 1.8 1.4	V V V V



**BUW44
BUW45
BUW46**

ELECTRICAL CHARACTERISTICS (continued)

Parameter	Test conditions	Min. Typ. Max.	Unit
t_{on} Turn-on time	$I_C = 10A$ $I_{B1} = 2A$ $V_{CC} = 250V$		0.75 μs
t_s Storage time	$I_C = 10A$ $I_{B1} = 2A$		3 μs
t_f Fall time	$I_{B2} = -2A$ $V_{CC} = 250V$		0.8 μs

* Pulsed: pulse duration = 300 μs , duty cycle = 1.5%

Safe operating areas

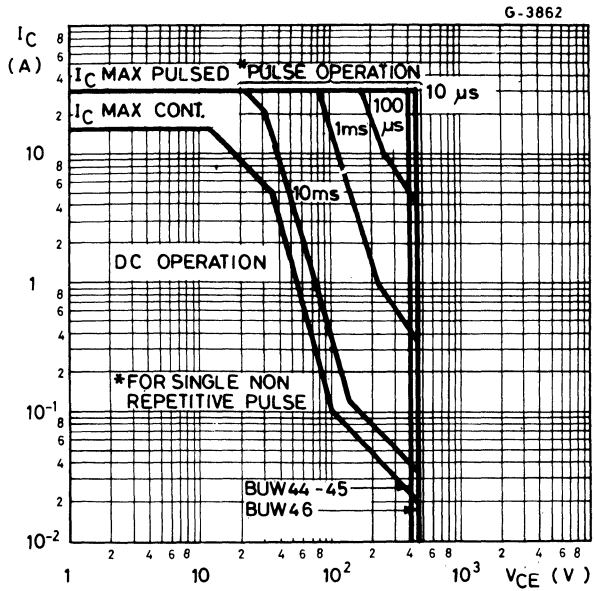

Thermal transient response

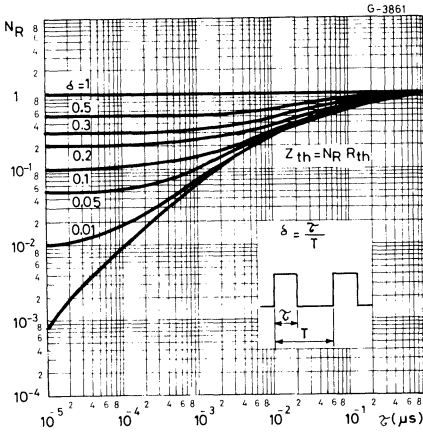

DC current gain

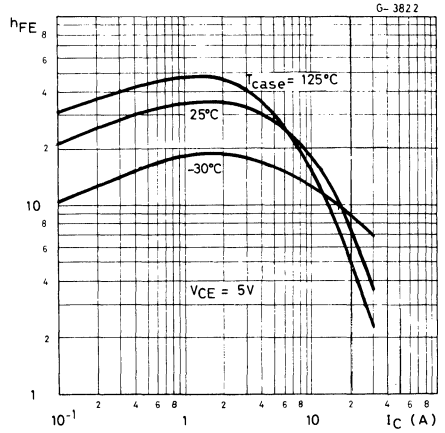

Collector-emitter saturation voltage

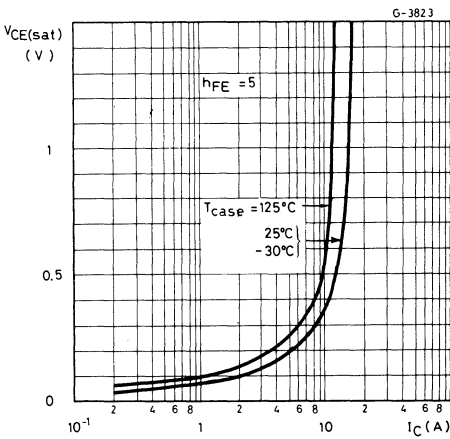

Collector-emitter saturation voltage

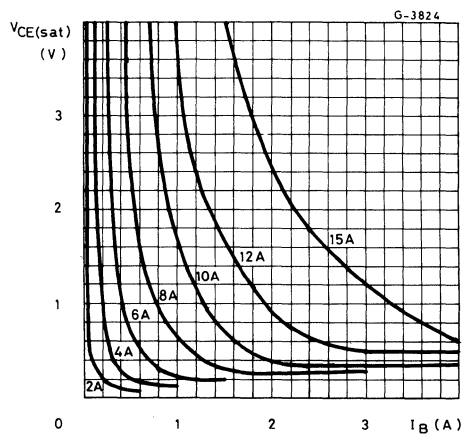



**BUW44
BUW45
BUW46**

Base-emitter saturation voltage

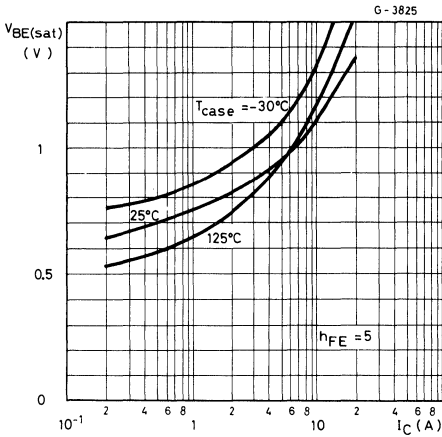

Saturated switching characteristics

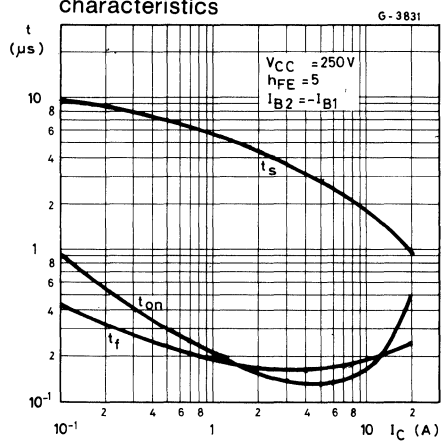

Clamped reverse bias safe operating areas

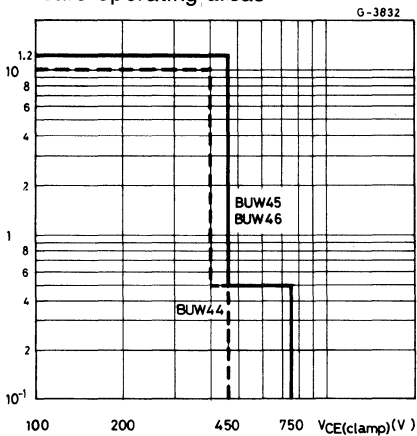

Clamped $E_{s,b}$ test circuit

TEST CONDITIONS:
 $5V > |-V_{BB}| \geq 2V$
 $I_C / I_B = 5$
 $2|I_{B1}| > |-I_{B2}| > I_{B1}$
 t_p = adjusted for nominal I_C
 R_{BB} = adjusted for I_{B2}

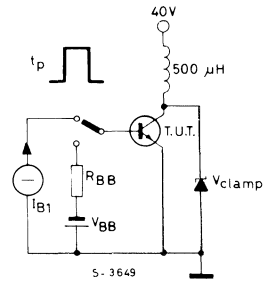

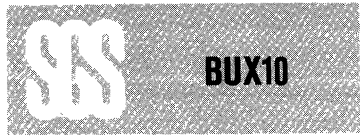

MULTIEPITAXIAL PLANAR NPN

HIGH CURRENT, HIGH SPEED, HIGH POWER TRANSISTOR

The BUX 10 is a silicon multiepitaxial planar NPN transistor in Jedec TO-3 metal case, intended for use in switching and linear applications in military and industrial equipment.

ABSOLUTE MAXIMUM RATINGS

V_{CBO}	Collector-base voltage ($I_E = 0$)	160	V
V_{CEX}	Collector-emitter voltage ($V_{BE} = -1.5V$)	160	V
V_{CEO}	Collector-emitter voltage ($I_B = 0$)	125	V
V_{EBO}	Emitter-base voltage ($I_C = 0$)	7	V
I_C	Collector current	25	A
I_{CM}	Collector peak current ($t_p = 10\text{ ms}$)	30	A
I_B	Base current	5	A
P_{tot}	Total power dissipation at $T_{case} \leq 25^\circ\text{C}$	150	W
T_{stg}	Storage temperature	-65 to 200	$^\circ\text{C}$
T_j	Junction temperature	200	$^\circ\text{C}$

INTERNAL SCHEMATIC DIAGRAM

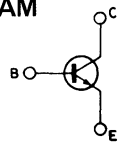

MECHANICAL DATA

Dimensions in mm

Collector connected to case

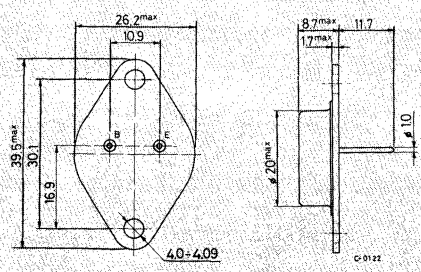

TO-3



BUX10

THERMAL DATA

$R_{th\ j-case}$	Thermal resistance junction-case	max 1.17 °C/W
------------------	----------------------------------	---------------

ELECTRICAL CHARACTERISTICS ($T_{case} = 25^{\circ}C$ unless otherwise specified)

Parameter	Test conditions	Min. Typ. Max.	Unit
I_{CEO} Collector cutoff current ($I_B=0$)	$V_{CE}=100V$	1.5	mA
I_{CEX} Collector cutoff current	$V_{CE}=160V$ $V_{BE}=-1.5V$ $T_{case}=125^{\circ}C$ $V_{CE}=160V$ $V_{BE}=-1.5V$	1.5 6	mA mA
I_{EBO} Emitter cutoff current ($I_C=0$)	$V_{EB}=5V$	1	mA
$V_{CEO(sus)}$ *Collector-emitter sustaining voltage	$I_C = 200mA$	125	V
V_{EBO} Emitter-base voltage ($I_C=0$)	$I_E = 50mA$	7	V
$V_{CE(sat)}$ * Collector-emitter saturation voltage	$I_C = 10A$ $I_B = 1A$ $I_C = 20A$ $I_B = 2A$	0.3 0.6 0.7 1.2	V V
$V_{BE(sat)}$ * Base-emitter saturation voltage	$I_C = 20A$ $I_B = 2A$	1.6 2	V
h_{FE} * DC current gain	$I_C = 10A$ $V_{CE}=2V$ $I_C = 20A$ $V_{CE}=4V$	20 60 10	— —
$I_{s/b}$ Second breakdown collector current	$V_{CE}=30V$ $t = 1s$ $V_{CE}=48V$ $t = 1s$	5 1	A A
f_T Transition frequency	$I_C = 1A$ $V_{CE}=15V$ $f = 10MHz$	8	MHz

ELECTRICAL CHARACTERISTICS (continued)

Parameter		Test conditions	Min. Typ. Max.	Unit
t_{on}	Turn-on time (fig. 2)	$I_C = 20A$ $V_{CC} = 30V$	$I_{B1} = 2A$	0.5 1.5 μs
t_s	Storage time (fig. 2)	$I_C = 20A$ $V_{CC} = 30V$	$I_{B1} = -I_{B2} = 2A$	0.6 1.2 μs
t_f	Fall time (fig. 2)			0.15 0.3 μs
Clamped $E_{s/b}$ Collector current (fig. 1)		$V_{clamp} = 125V$ $L = 500\mu H$	20	A

* Pulsed: pulse duration = 300 μs , duty cycle $\leq 2\%$

Safe operating areas

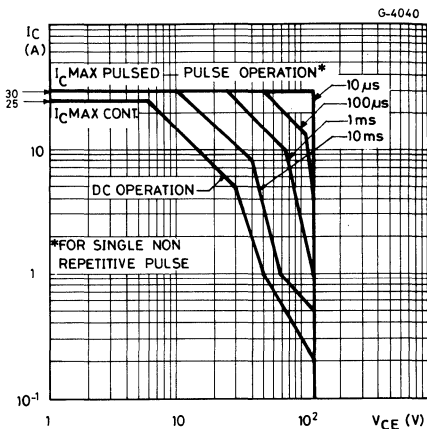

Derating curves

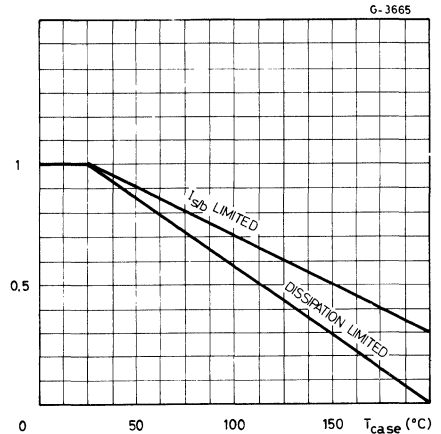



BUX10

Thermal transient response

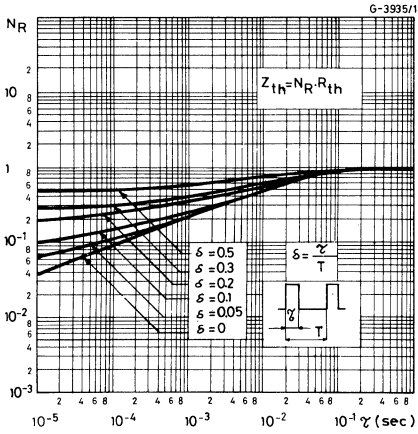

DC current gain

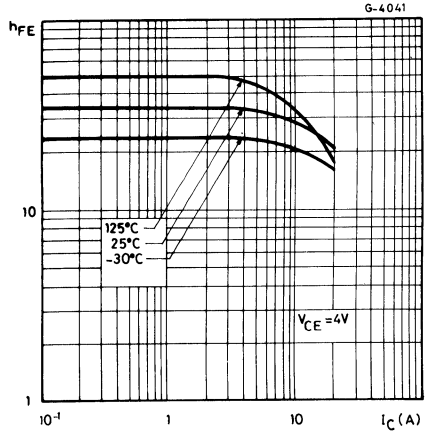

Collector-emitter saturation voltage

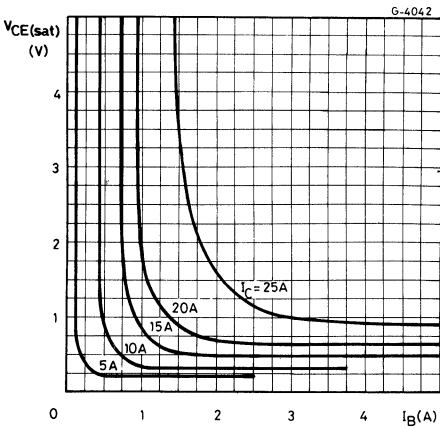

Collector-emitter saturation voltage

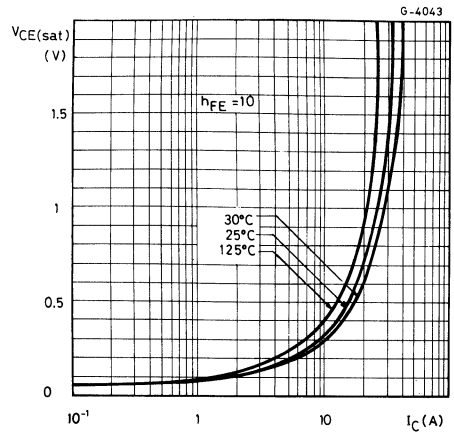

Base-emitter saturation voltage

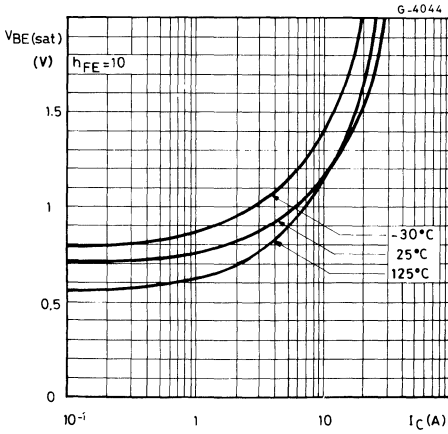

Saturated switching characteristics

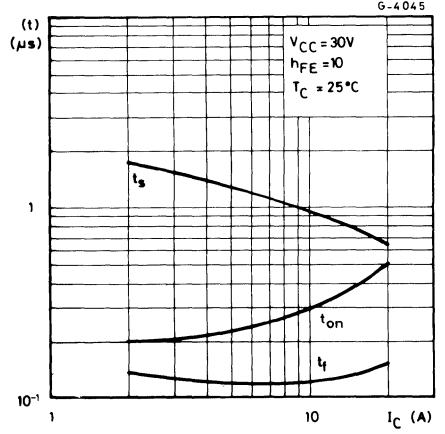

Saturated switching characteristics

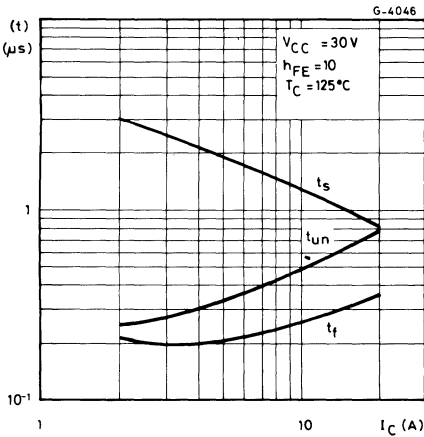

Transition frequency

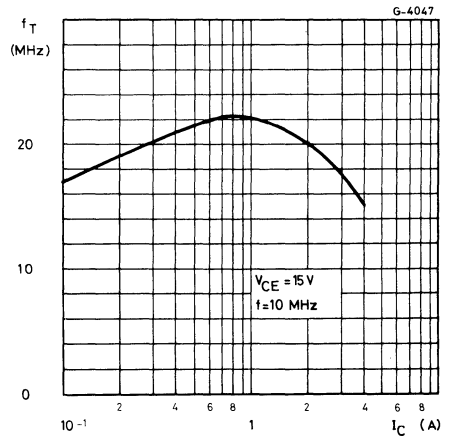

Collector-base capacitance

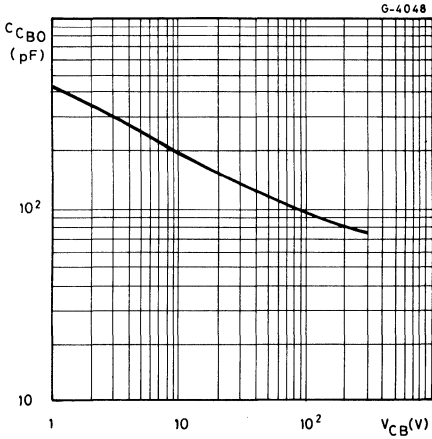

Clamped reverse bias safe operating area

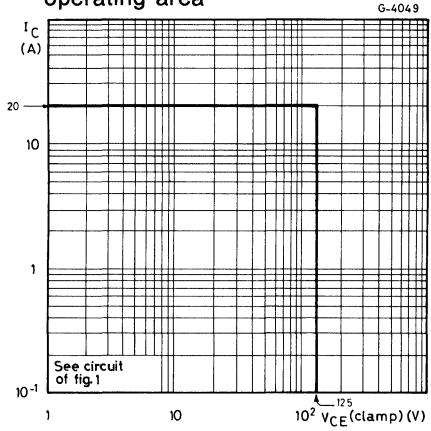

Fig. 1 – Clamped $E_{s,b}$ test circuit

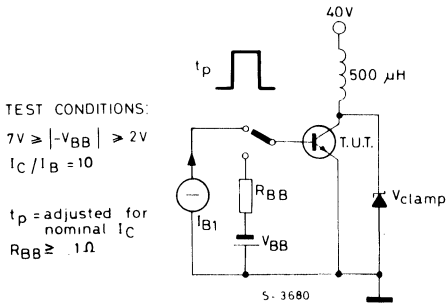
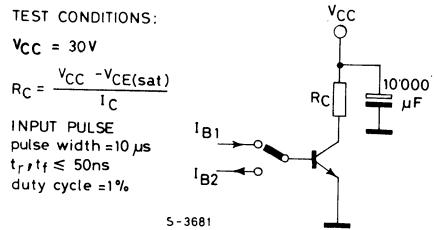
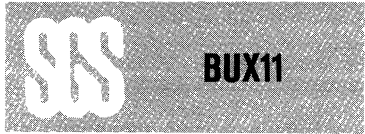

Fig. 2 – Switching times test circuit (resistive load)





MULTIEPITAXIAL PLANAR NPN

HIGH CURRENT, HIGH SPEED, HIGH POWER TRANSISTOR

The BUX 11 is a silicon multiepitaxial planar NPN transistor in Jeduc TO-3 metal case, intended for use in switching and linear applications in military and industrial equipment.

ABSOLUTE MAXIMUM RATINGS

V_{CBO}	Collector-base voltage ($I_E=0$)	250	V
V_{CEX}	Collector-emitter voltage ($V_{BE}=-1.5V$)	250	V
V_{CEO}	Collector-emitter voltage ($I_B=0$)	200	V
V_{EBO}	Emitter-base voltage ($I_C=0$)	7	V
I_C	Collector current	20	A
I_{CM}	Collector peak current ($t_p=10$ ms)	25	A
I_B	Base current	4	A
P_{tot}	Total power dissipation at $T_{case} \leq 25^\circ C$	150	W
T_{stg}	Storage temperature	-65 to 200	$^\circ C$
T_j	Junction temperature	200	$^\circ C$

INTERNAL SCHEMATIC DIAGRAM

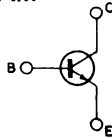

MECHANICAL DATA

Dimensions in mm

Collector connected to case

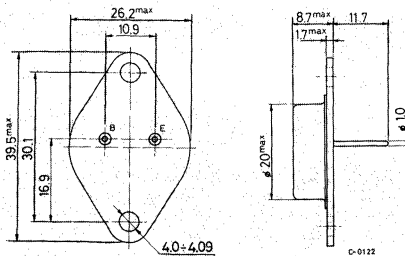

TO-3



BUX11

THERMAL DATA

$R_{th\ j-case}$	Thermal resistance junction-case	max 1.17 °C/W
------------------	----------------------------------	---------------

ELECTRICAL CHARACTERISTICS ($T_{case} = 25^\circ\text{C}$ unless otherwise specified)

Parameter	Test conditions	Min.	Typ.	Max.	Unit	
I_{CEO}	Collector cutoff current ($I_B = 0$)	$V_{CE} = 160\text{V}$			1.5	mA
I_{CEX}	Collector cutoff current	$V_{CE} = 250\text{V}$ $V_{BE} = -1.5\text{V}$ $V_{CE} = 250\text{V}$ $V_{BE} = -1.5\text{V}$ $T_{case} = 125^\circ\text{C}$			1.5 6	mA mA
I_{EBO}	Emitter cutoff current ($I_C = 0$)	$V_{EB} = 5\text{V}$			1	mA
$V_{CEO(sus)}$	*Collector-emitter sustaining voltage	$I_C = 200\text{mA}$			200	V
V_{EBO}	Emitter-base voltage ($I_C = 0$)	$I_E = 50\text{mA}$			7	V
$V_{CE(sat)}$	*Collector-emitter saturation voltage	$I_C = 6\text{A}$ $I_B = 0.6\text{A}$ $I_C = 12\text{A}$ $I_B = 1.5\text{A}$			0.3 0.6 0.6 1.5	V V
$V_{BE(sat)}$	*Base-emitter saturation voltage	$I_C = 12\text{A}$ $I_B = 1.5\text{A}$			1.3 1.5	V
h_{FE}	DC current gain	$I_C = 6\text{A}$ $V_{CE} = 2\text{V}$ $I_C = 12\text{A}$ $V_{CE} = 4\text{V}$			20 10	60 —
$I_{s/b}$	Second breakdown collector current	$V_{CE} = 30\text{V}$ $t = 1\text{s}$ $V_{CE} = 140\text{V}$ $t = 1\text{s}$			5 0.15	A A
f_T	Transition frequency	$I_C = 1\text{A}$ $V_{CE} = 15\text{V}$ $f = 10\text{MHz}$			8	MHz

ELECTRICAL CHARACTERISTICS (continued)

Parameter		Test conditions	Min. Typ. Max.	Unit
t_{on}	Turn-on time (fig. 2)	$I_C = 12A$ $I_{B1} = 1.5A$ $V_{CC} = 150V$	0.3 1	μs
t_s	Storage time (fig. 2)	$I_C = 12A$ $I_{B1} = 1.5A$ $I_{B2} = -1.5A$ $V_{CC} = 150V$	1.2 1.8	μs
t_f	Fall time (fig. 2)		0.24 0.4	μs
Clamped $E_{s/b}$ Collector current (fig. 1)		$V_{clamp} = 200V$ $L = 500\mu H$	12	A

* Pulsed: pulse duration = 300 μs , duty cycle $\leq 2\%$

Safe operating areas

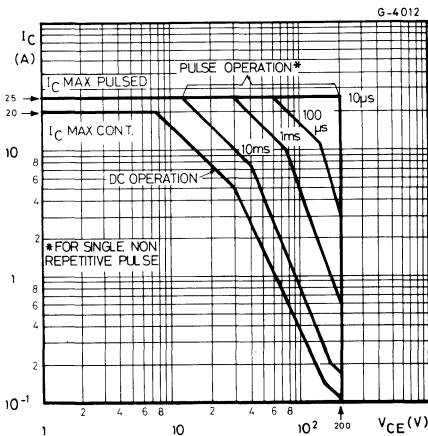

Derating curves

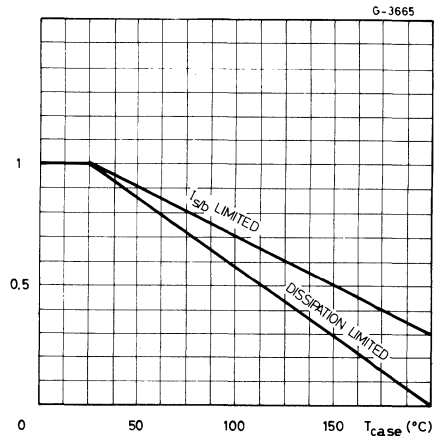



BUX11

Thermal transient response

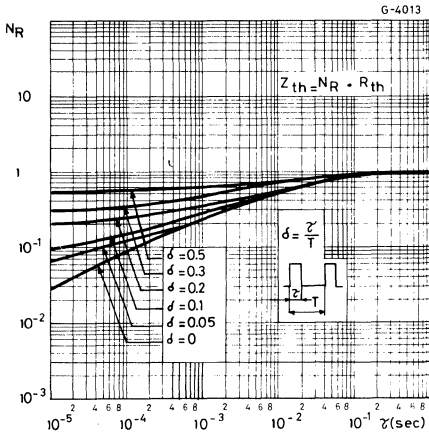

DC current gain

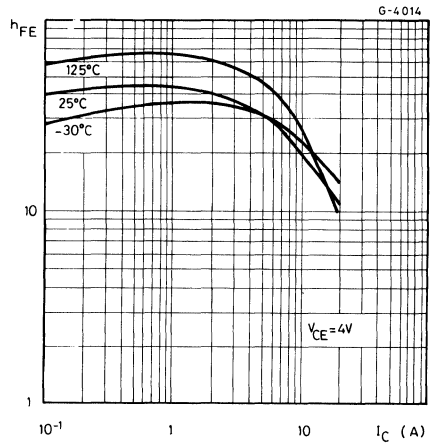

Collector-emitter saturation voltage

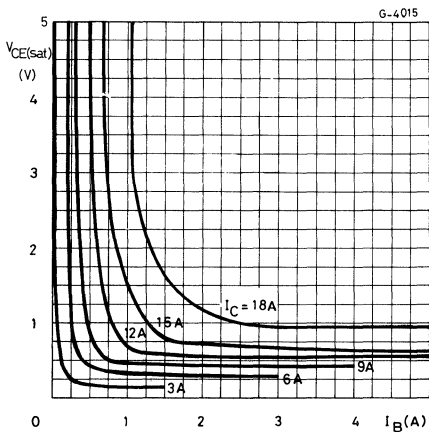

Collector-emitter saturation voltage

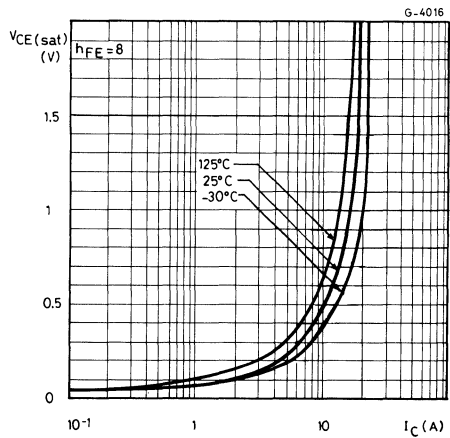

Base-emitter saturation voltage

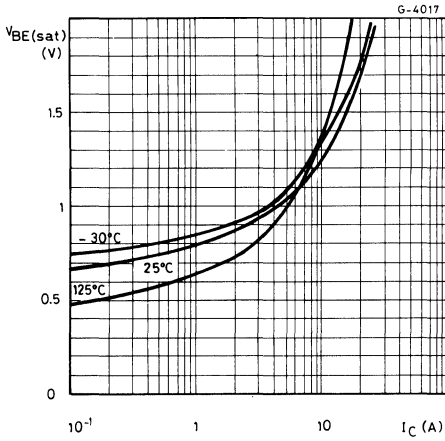

Saturated switching characteristics

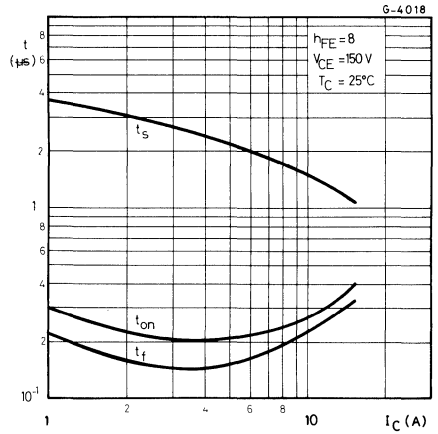

Saturated switching characteristics

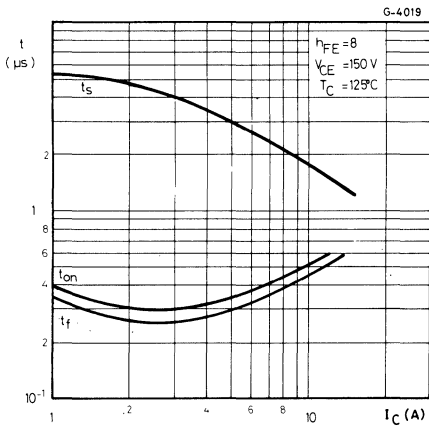

Transition frequency

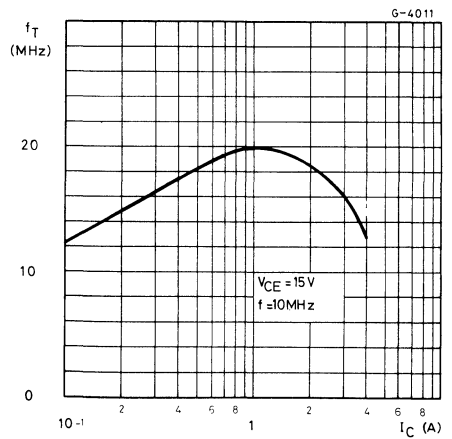



BUX11

Collector-base capacitance

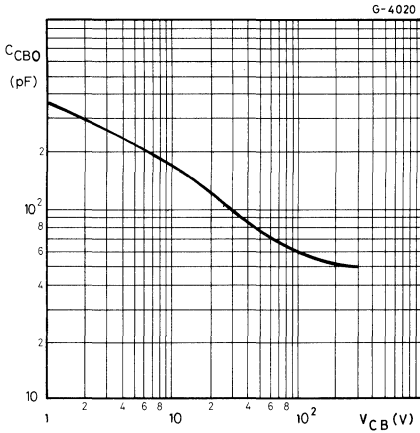

Clamped reverse bias safe operating area

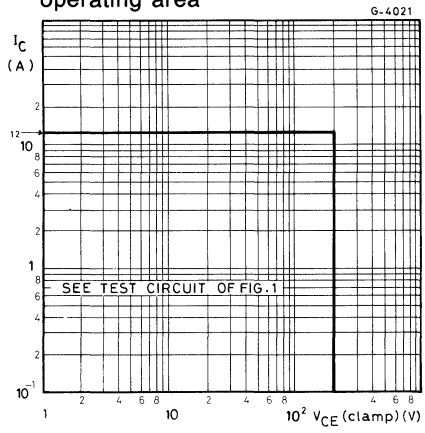

Fig. 1 — Clamped $E_{s/b}$ test circuit

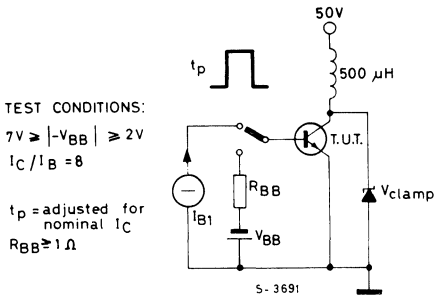

Fig. 2 — Switching times test circuit (resistive load)

TEST CONDITIONS:

$V_{CC} = 150V$

$$R_C = \frac{V_{CC} - V_{CE(sat)}}{I_C}$$

INPUT PULSE
 pulse width = $10 \mu s$
 $t_r, t_f \leq 50ns$
 duty cycle = 1%

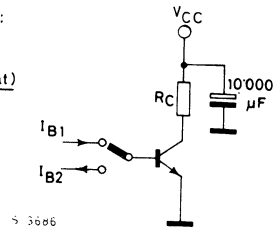



MULTIEPITAXIAL PLANAR NPN

HIGH CURRENT, HIGH SPEED, HIGH POWER TRANSISTOR

The BUX 11N is a silicon multiepitaxial planar NPN transistor in Jedec TO-3 metal case, intended for use in switching and linear applications in military and industrial equipment.

ABSOLUTE MAXIMUM RATINGS

V_{CBO}	Collector-base voltage ($I_E = 0$)	220	V
V_{CEX}	Collector-emitter voltage ($V_{BE} = -1.5V$)	220	V
V_{CEO}	Collector-emitter voltage ($I_B = 0$)	160	V
V_{EBO}	Emitter-base voltage ($I_C = 0$)	7	V
I_C	Collector current	20	A
I_{CM}	Collector peak current ($t_p = 10$ ms)	25	A
I_B	Base current	5	A
P_{tot}	Total power dissipation at $T_{case} \leq 25^\circ C$	150	W
T_{stg}	Storage temperature	-65 to 200	$^\circ C$
T_j	Junction temperature	200	$^\circ C$

INTERNAL SCHEMATIC DIAGRAM

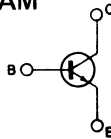

MECHANICAL DATA

Dimensions in mm

Collector connected to case

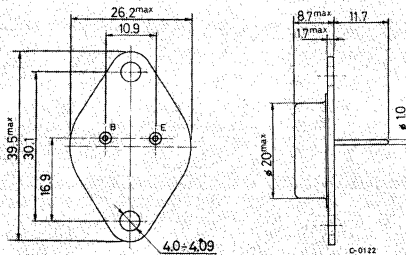

TO-3



BUX11N

THERMAL DATA

$R_{th\ j-case}$	Thermal resistance junction-case	max 1.17 °C/W
------------------	----------------------------------	---------------

ELECTRICAL CHARACTERISTICS ($T_{case} = 25^{\circ}C$ unless otherwise specified)

Parameter	Test conditions	Min. Typ. Max.	Unit
I_{CEO} Collector cutoff current ($I_B = 0$)	$V_{CE} = 130V$	1.5	mA
I_{CEX} Collector cutoff current	$V_{CE} = 220V$ $V_{BE} = -1.5V$ $V_{CE} = 220V$ $V_{BE} = -1.5V$ $T_{case} = 125^{\circ}C$	1.5 6	mA mA
I_{EBO} Emitter cutoff current ($I_C = 0$)	$V_{EB} = 5V$	1	mA
$V_{CEO(sus)}$ * Collector-emitter sustaining voltage	$I_C = 200mA$ $L = 25\ mH$	160	V
V_{EBO} Emitter-base voltage ($I_C = 0$)	$I_E = 50mA$	7	V
$V_{CE(sat)}$ * Collector-emitter saturation voltage	$I_C = 8A$ $I_B = 0.8A$ $I_C = 15A$ $I_B = 1.88A$	0.3 0.6 0.6 1.5	V V
$V_{BE(sat)}$ * Base-emitter saturation voltage	$I_C = 15A$ $I_B = 1.88A$	1.4 1.8	V
h_{FE} * DC current gain	$I_C = 8A$ $V_{CE} = 2V$ $I_C = 15A$ $V_{CE} = 4V$	20 60 10	— —
$I_{s/b}$ Second breakdown collector current	$V_{CE} = 30V$ $t = 1s$ $V_{CE} = 140V$ $t = 1s$	5 0.15	A A
f_T Transition frequency	$V_{CE} = 15V$ $I_C = 1A$ $f = 10MHz$	8	MHz

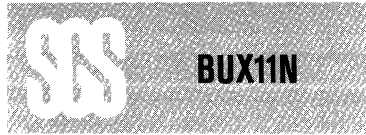

ELECTRICAL CHARACTERISTICS (continued)

Parameter	Test conditions	Min. Typ. Max.	Unit
t_{on} Turn-on time (fig. 2)	$I_C = 15A$ $I_{B1} = 1.88A$ $V_{CC} = 30V$	0.4 1.5	μs
t_s Storage time (fig. 2)	$I_C = 15A$ $I_{B1} = -I_{B2} = 1.88A$ $V_{CC} = 30V$	0.75 1.5	μs
t_f Fall time (fig. 2)		0.14 0.5	μs
Clamped $E_{s/b}$ Collector current (fig. 1)	$V_{clamp} = 160V$ $L = 500\mu H$	15	A

* Pulsed: pulse duration = 300 μs , duty cycle $\leq 2\%$

Safe operating areas

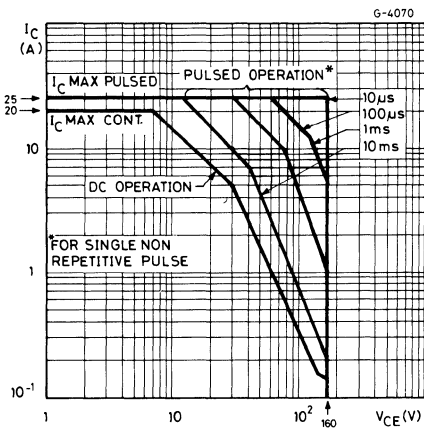

Derating curves

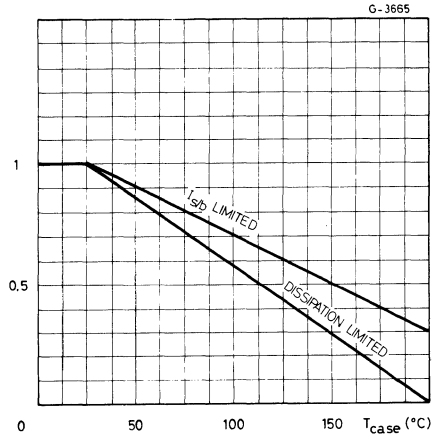



BUX11N

Thermal transient response

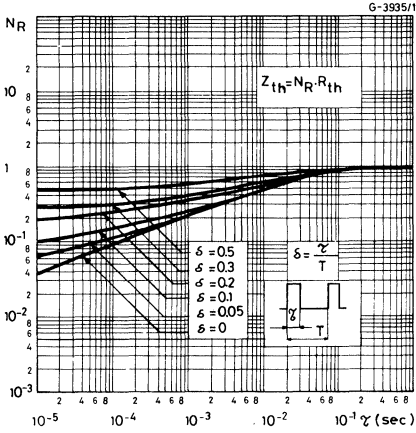

DC current gain

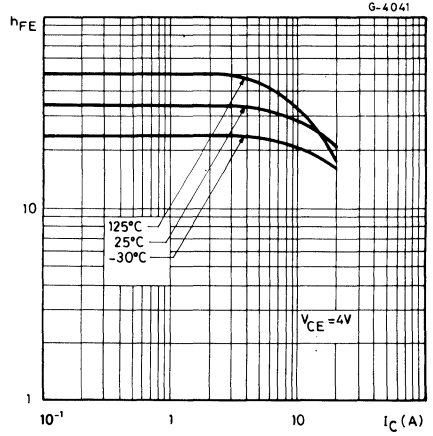

Collector-emitter saturation voltage

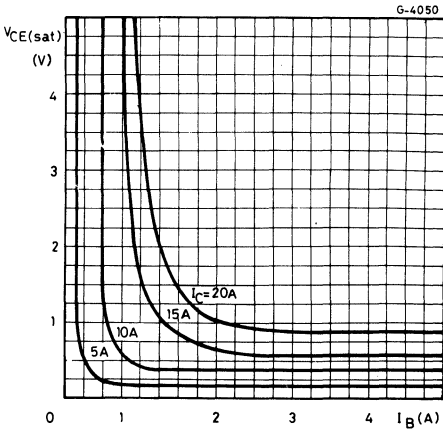

Collector-emitter saturation voltage

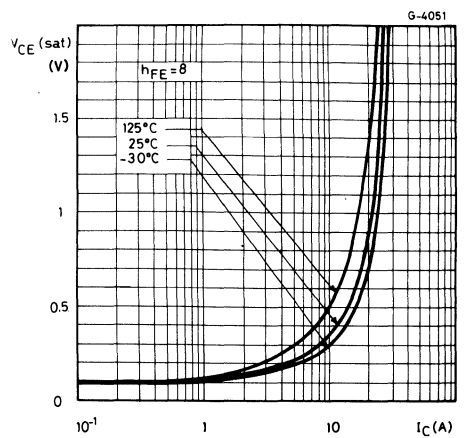

Base-emitter saturation voltage

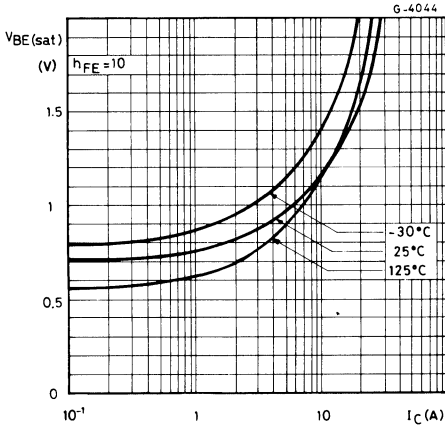

Saturated switching characteristics

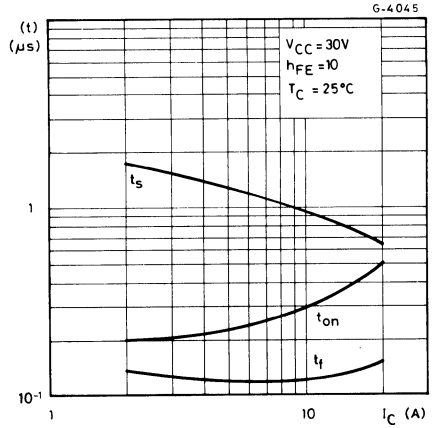

Saturated switching characteristics

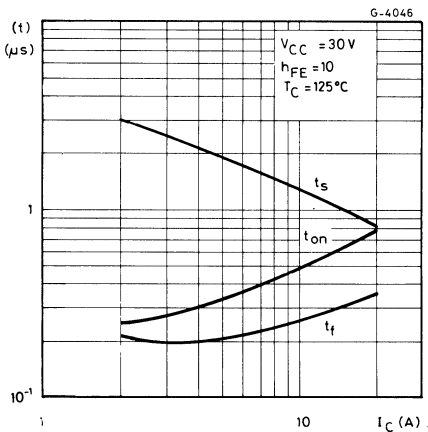

Transition frequency

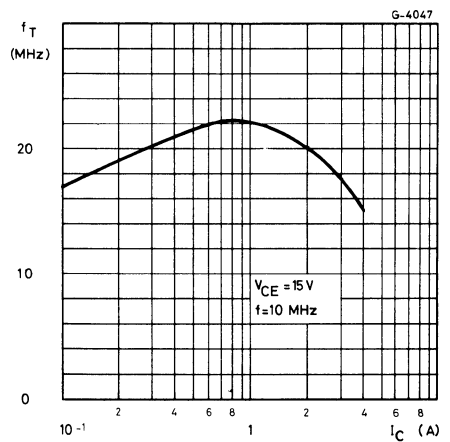

Collector base capacitance

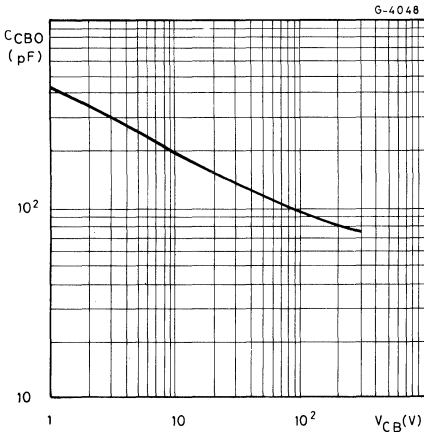

Clamped reverse bias safe operating areas

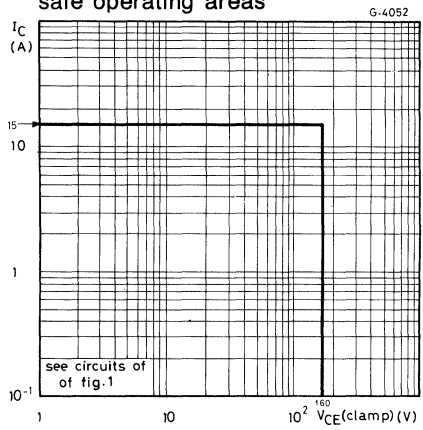
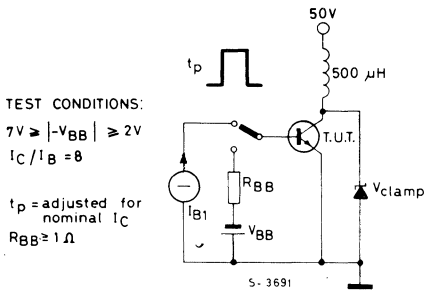

Fig. 1 – Clamped $E_{s/b}$ test circuit

Fig. 2 – Switching times test circuit (Resistive load)



TEST CONDITIONS:

$V_{CC} = 30V$
 $R_C = \frac{V_{CC} - V_{CE(sat)}}{I_C}$

INPUT PULSE
 pulse width = $10 \mu s$
 $t_r, t_f \leq 50ns$
 duty cycle = 1%

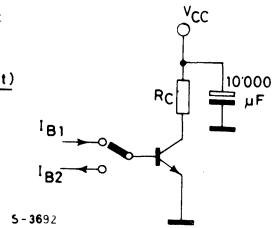



MULTIEPITAXIAL PLANAR NPN

HIGH CURRENT, HIGH SPEED, HIGH POWER TRANSISTOR

The BUX 12 is a silicon multi-epitaxial planar NPN transistor in Jedec TO-3 metal case, intended for use in switching and linear applications in military and industrial equipment.

ABSOLUTE MAXIMUM RATINGS

V_{CBO}	Collector-base voltage ($I_E = 0$)	300	V
V_{CEX}	Collector-emitter voltage ($V_{BE} = -1.5V$)	300	V
V_{CEO}	Collector-emitter voltage ($I_B = 0$)	250	V
V_{EBO}	Emitter-base voltage ($I_C = 0$)	7	V
I_C	Collector current	20	A
I_{CM}	Collector peak current ($t_p = 10$ ms)	25	A
I_B	Base current	4	A
P_{tot}	Total power dissipation at $T_{case} \leq 25^\circ C$	150	W
T_{stg}	Storage temperature	-65 to 200	$^\circ C$
T_j	Junction temperature	200	$^\circ C$

INTERNAL SCHEMATIC DIAGRAM

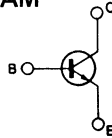

MECHANICAL DATA

Dimensions in mm

Collector connected to case

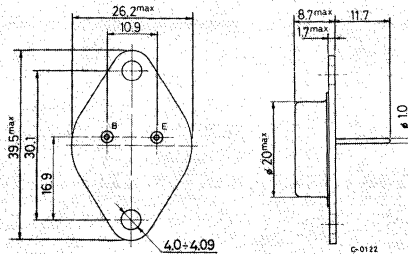

TO-3

**BUX12****THERMAL DATA**

$R_{th\ j-case}$	Thermal resistance junction-case	max 1.17 °C/W
------------------	----------------------------------	---------------

ELECTRICAL CHARACTERISTICS ($T_{case} = 25^{\circ}C$ unless otherwise specified)

Parameter	Test conditions	Min.	Typ.	Max.	Unit	
I_{CEO}	Collector cutoff current ($I_B = 0$)	$V_{CE} = 200V$			1.5	mA
I_{CEX}	Collector cutoff current	$V_{CE} = 300V$ $V_{BE} = -1.5V$			1.5	mA
		$T_{case} = 125^{\circ}C$			6	mA
I_{EBO}	Emitter cutoff current ($I_C = 0$)	$V_{EB} = 5V$			1	mA
$V_{CEO(sus)}$	*Collector-emitter sustaining voltage	$I_C = 200mA$			250	V
V_{EBO}	Emitter-base voltage ($I_C = 0$)	$I_E = 50mA$			7	V
$V_{CE(sat)}$	* Collector-emitter saturation voltage	$I_C = 5A$	$I_B = 0.5A$	0.22	1	V
		$I_C = 10A$	$I_B = 1.25A$	0.5	1.5	V
$V_{BE(sat)}$	* Base-emitter saturation voltage	$I_C = 10A$	$I_B = 1.25A$	1.23	1.5	V
h_{FE}	* DC current gain	$I_C = 5A$	$V_{CE} = 4V$	20	60	—
		$I_C = 10A$	$V_{CE} = 4V$	10		—
$I_{s/b}$	Second breakdown collector current	$V_{CE} = 30V$	$t = 1s$	5		A
		$V_{CE} = 140V$	$t = 1s$	0.15		A
f_T	Transition frequency	$I_C = 1A$	$V_{CE} = 15V$	8		MHz
		$f = 10MHz$				



ELECTRICAL CHARACTERISTICS (continued)

Parameter	Test conditions	Min. Typ. Max.	Unit
t_{on} Turn-on time (fig. 2)	$I_C = 10A$ $I_{B1} = 1.25A$ $V_{CC} = 150V$	0.28 1	μs
t_s Storage time (fig. 2)	$I_C = 10A$ $I_{B1} = 1.25A$ $I_{B2} = -1.25A$ $V_{CC} = 150V$	1.45 2	μs
t_f Fall time (fig. 2)		0.23 0.5	μs
Clamped $E_{s/b}$ Collector current (fig. 1)	$V_{clamp} = 250V$ $L = 500\mu H$	10	A

* Pulsed: pulse duration = 300 μs , duty cycle $\leq 2\%$

Safe operating areas

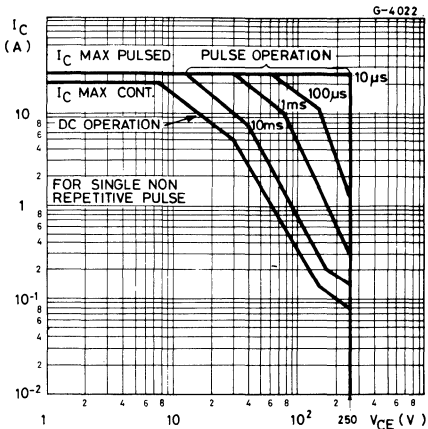

Derating curves

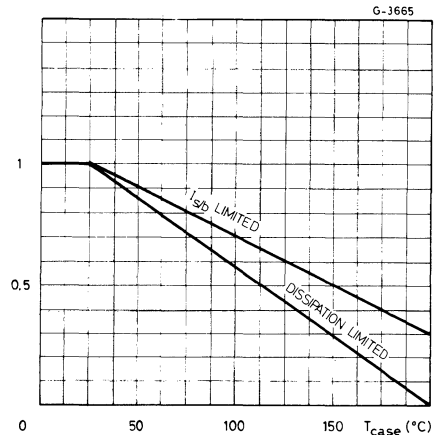



BUX12

Thermal transient response

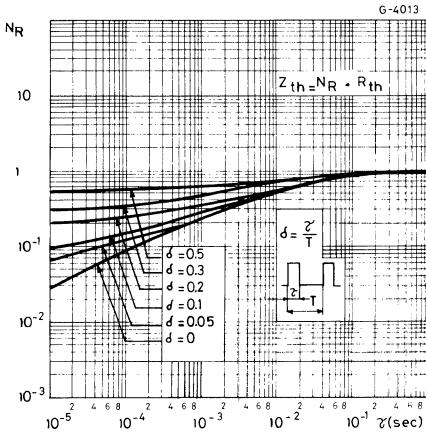

DC current gain

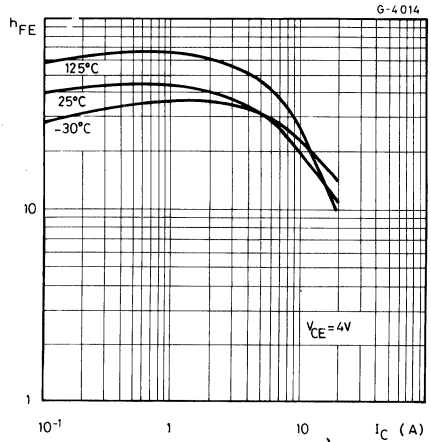

Collector-emitter saturation voltage

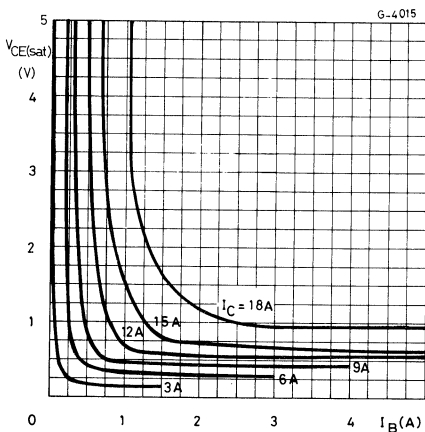

Collector-emitter saturation voltage

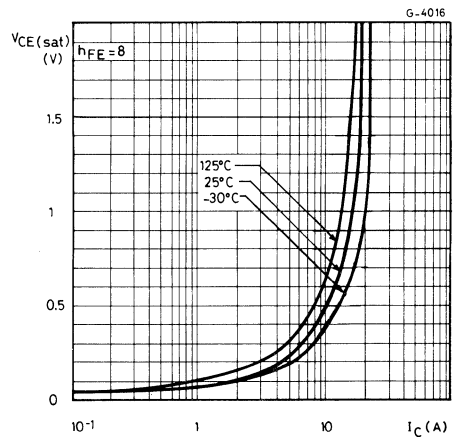

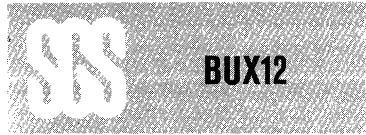

Base-emitter saturation voltage

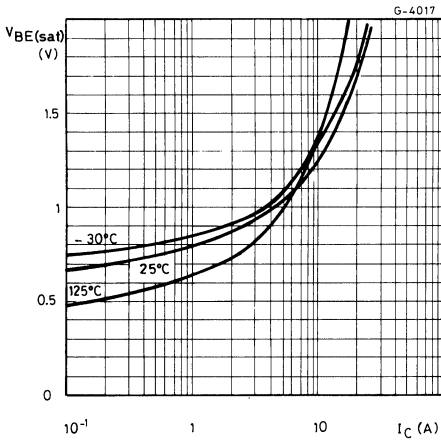

Saturated switching characteristics

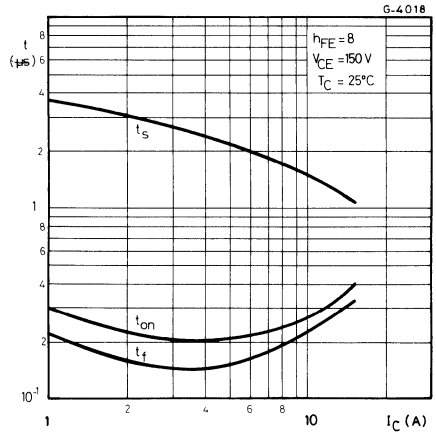

Saturated switching characteristics

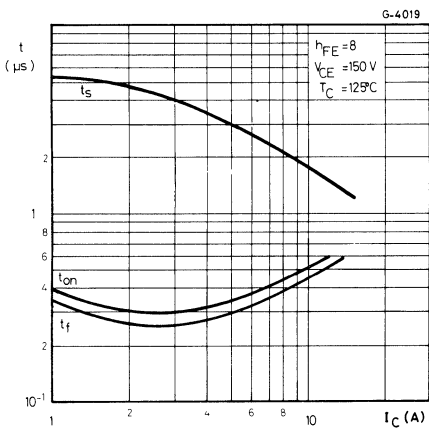

Transition frequency

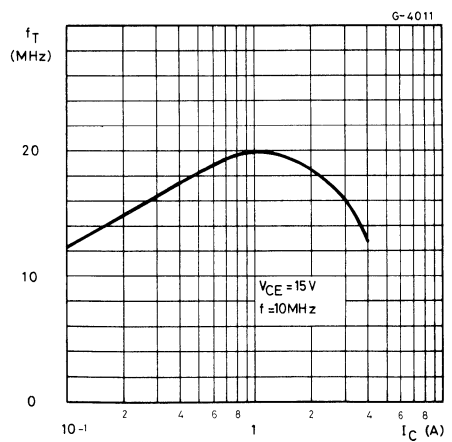

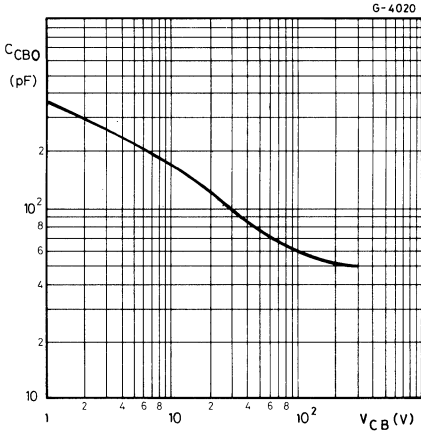
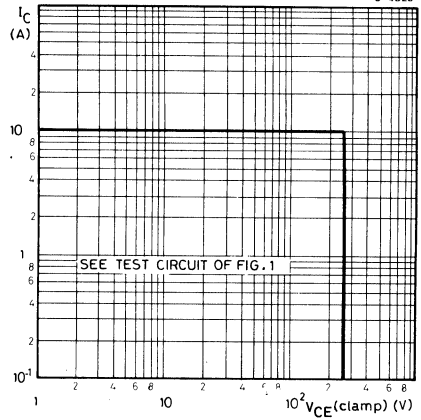
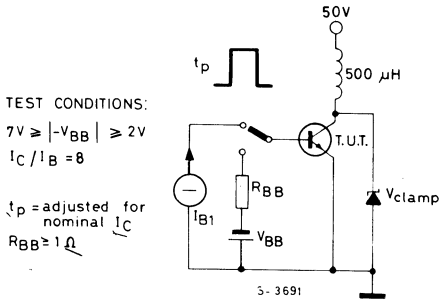
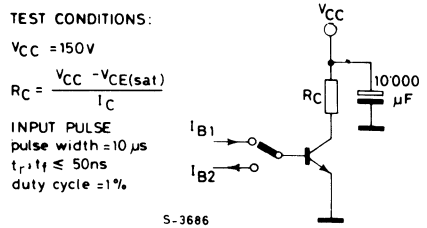
Collector-base capacitance

Clamped reverse bias safe operating areas

Fig. 1 – Clamped $E_{s,b}$ test circuit

Fig. 2 – Switching times test circuit (resistive load)

MULTIEPITAXIAL MESA NPN



HIGH VOLTAGE POWER SWITCH

The BUX 13 is a silicon multiepitaxial mesa NPN transistor in Jedec TO-3 metal case, intended for high voltage, fast switching applications.

ABSOLUTE MAXIMUM RATINGS

V_{CES}	Collector-emitter voltage ($V_{BE} = 0$)	400	V
V_{CER}	Collector-emitter voltage ($R_{BE} \leq 100\Omega$)	390	V
V_{CEO}	Collector-emitter voltage ($I_B = 0$)	325	V
V_{EBO}	Base-emitter voltage ($I_C = 0$)	7	V
I_C	Collector current	15	A
I_{CM}	Collector peak current ($t_p \leq 10ms$)	20	A
I_B	Base current	3	A
P_{tot}	Total power dissipation at $T_{case} \leq 25^\circ C$	150	W
T_{stg}	Storage temperature	-65 to 200	$^\circ C$
T_j	Junction temperature	200	$^\circ C$

INTERNAL SCHEMATIC DIAGRAM

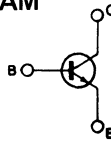

MECHANICAL DATA

Dimensions in mm

Collector connected to case

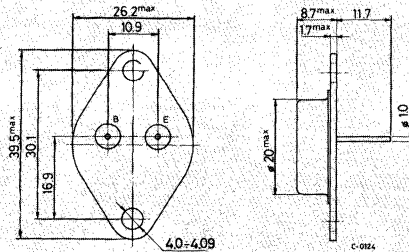

TO-3

**BUX13****THERMAL DATA**

$R_{th\ j-case}$	Thermal resistance junction-case	max 1.17 °C/W
------------------	----------------------------------	---------------

ELECTRICAL CHARACTERISTICS ($T_{case} = 25^{\circ}C$ unless otherwise specified)

Parameter	Test conditions	Min. Typ. Max.	Unit
I_{CES}	Collector cutoff current ($V_{BE} = 0$)	$V_{CE} = 400V$ $V_{CE} = 400V$ $T_{case} = 125^{\circ}C$	1.5 mA 6 mA
I_{CEO}	Collector cutoff current ($I_B = 0$)	$V_{CE} = 260V$	1.5 mA
I_{EBO}	Emitter cutoff current ($I_C = 0$)	$V_{EB} = 7V$	1 mA
$V_{CEO(sus)}$ *	Collector-emitter sustaining voltage ($I_B = 0$)	$I_C = 100mA$	325 V
$V_{CE(sat)}$ *	Collector-emitter saturation voltage	$I_C = 4A$ $I_B = 0.8A$ $I_C = 8A$ $I_B = 1.6A$	0.8 V 1.5 V
$V_{BE(sat)}$ *	Base-emitter saturation voltage	$I_C = 8A$ $I_B = 1.6A$	1.5 V
h_{FE} *	DC current gain	$I_C = 4A$ $V_{CE} = 4V$ $I_C = 8A$ $V_{CE} = 4V$	15 60 8 —
f_T	Transition frequency	$I_C = 1A$ $V_{CE} = 15V$ $f = 10MHz$	8 MHz
t_{on}	Turn-on time	$I_C = 8A$ $I_{B1} = 1.6A$ $V_{CC} = 150V$	1.2 μs
t_s	Storage time	$I_C = 8A$	2.5 μs
t_f	Fall time	$I_{B1} = -I_{B2} = 1.6A$ $V_{CC} = 150V$	1 μs

* Pulsed: pulse duration = 300 μs , duty cycle $\leq 2\%$.

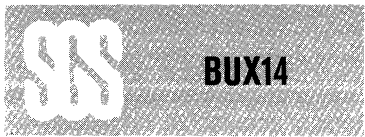

MULTIEPITAXIAL MESA NPN

HIGH VOLTAGE POWER SWITCH

The BUX 14 is a silicon multiepitaxial mesa NPN transistor in Jedec TO-3 metal case, intended for high voltage, fast switching applications

ABSOLUTE MAXIMUM RATINGS

V_{CES}	Collector-emitter voltage ($V_{BE} = 0$)	450	V
V_{CER}	Collector-emitter voltage ($R_{BE} \leq 100\Omega$)	440	V
V_{CEO}	Collector-emitter voltage ($I_B = 0$)	400	V
V_{EBO}	Base-emitter voltage ($I_C = 0$)	7	V
I_C	Collector current	10	A
I_{CM}	Collector peak current ($t_p \leq 10ms$)	15	A
I_B	Base current	2	A
P_{tot}	Total power dissipation at $T_{case} \leq 25^\circ C$	150	W
T_{stg}	Storage temperature	-65 to 200	$^\circ C$
T_j	Junction temperature	200	$^\circ C$

INTERNAL SCHEMATIC DIAGRAM

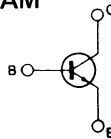

MECHANICAL DATA

Dimensions in mm

Collector connected to case

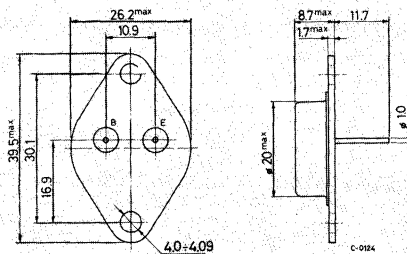

TO-3



BUX14

THERMAL DATA

$R_{th\ j-case}$	Thermal resistance junction-case	max 1.17 °C/W
------------------	----------------------------------	---------------

ELECTRICAL CHARACTERISTICS ($T_{case} = 25^{\circ}C$ unless otherwise specified)

Parameter	Test conditions	Min.	Typ.	Max.	Unit
I_{CES}	Collector cutoff current ($V_{BE} = 0$) $V_{CE} = 450V$ $V_{CE} = 450V$ $T_{case} = 125^{\circ}C$			1.5 6	mA mA
I_{CEO}	Collector cutoff current ($I_B = 0$) $V_{CE} = 320V$			1.5	mA
I_{EBO}	Emitter cutoff current ($I_C = 0$) $V_{EB} = 7V$			1	mA
$V_{CEO(sus)}$ * Collector-emitter sustaining voltage ($I_B = 0$)	$I_C = 100mA$	400			V
$V_{CE(sat)}$ * Collector-emitter saturation voltage	$I_C = 3A$ $I_B = 0.6A$ $I_C = 6A$ $I_B = 1.2A$			0.6 1.5	V V
$V_{BE(sat)}$ * Base-emitter saturation voltage	$I_C = 6A$ $I_B = 1.2A$			1.5	V
h_{FE} * DC current gain	$I_C = 3A$ $V_{CE} = 4V$ $I_C = 6A$ $V_{CE} = 4V$	15 8		60	— —
f_T Transition frequency	$I_C = 1A$ $V_{CE} = 15V$ $f = 10MHz$	8			MHz
t_{on} Turn-on time	$I_C = 6A$ $I_{B1} = 1.2A$ $V_{CC} = 150V$			1.4	μs
t_s Storage time	$I_C = 6A$ $I_{B1} = -I_{B2} = 1.2A$ $V_{CC} = 150V$			3	μs
t_f Fall time				1.2	μs

* Pulsed: pulse duration = 300 μs , duty cycle $\leq 2\%$.

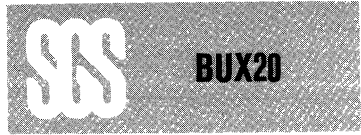

MULTIEPITAXIAL PLANAR NPN

HIGH CURRENT, HIGH SPEED, HIGH POWER TRANSISTOR

The BUX 20 is a silicon multiepitaxial planar NPN transistor in modified Jødec TO-3 metal case, intended for use in switching and linear applications in military and industrial equipment.

ABSOLUTE MAXIMUM RATINGS

V_{CBO}	Collector-base voltage ($I_E = 0$)	160	V
V_{CEX}	Collector-emitter voltage ($V_{BE} = -1.5$ V)	160	V
V_{CEO}	Collector-emitter voltage ($I_B = 0$)	125	V
V_{EBO}	Emitter-base voltage ($I_C = 0$)	7	V
I_C	Collector current	50	A
I_{CM}	Collector peak current ($t_p = 10$ ms)	60	A
I_B	Base current	10	A
P_{tot}	Total power dissipation at $T_{case} \leq 25^\circ\text{C}$	350	W
T_{stg}	Storage temperature	-65 to 200	$^\circ\text{C}$
T_j	Junction temperature	200	$^\circ\text{C}$

INTERNAL SCHEMATIC DIAGRAM

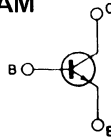

MECHANICAL DATA

Dimensions in mm

Collector connected to case

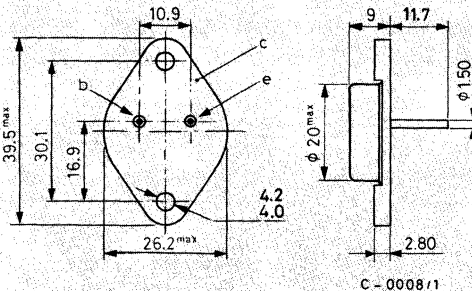

C - 0008/1

Modified TO-3

**BUX20****THERMAL DATA**

$R_{th\ j-case}$	Thermal resistance junction-case	max 0.5	°C/W
------------------	----------------------------------	---------	------

ELECTRICAL CHARACTERISTICS ($T_{case} = 25^{\circ}C$ unless otherwise specified)

Parameter	Test conditions	Min.	Typ.	Max.	Unit
I_{CEO} Collector cutoff current ($I_B=0$)	$V_{CE}=100V$			3	mA
I_{CEX} Collector cutoff current	$V_{CE}=160V$ $V_{BE}=-1.5V$			3	mA
	$T_{case}=125^{\circ}C$ $V_{CE}=160V$ $V_{BE}=-1.5V$			12	mA
I_{EBO} Emitter cutoff current ($I_C=0$)	$V_{EB}=5V$			1	mA
$V_{CEO(sus)}$ *Collector-emitter sustaining voltage	$I_C = 200mA$		125		V
V_{EBO} Emitter-base voltage ($I_C=0$)	$I_E = 50mA$		7		V
$V_{CE(sat)}$ * Collector-emitter saturation voltage	$I_C = 25A$ $I_B = 2.5A$		0.3	0.6	V
	$I_C = 50A$ $I_B = 5A$		0.55	1.2	V
$V_{BE(sat)}$ * Base-emitter saturation voltage	$I_C = 50A$ $I_B = 5A$		1.35	2	V
h_{FE} * DC current gain	$I_C = 25A$ $V_{CE}=2V$		20	60	—
	$I_C = 50A$ $V_{CE}=4V$		10		—
$I_{s/b}$ Second breakdown collector current	$V_{CE}=40V$ $t = 1s$		1.5		A
	$V_{CE}=20V$ $t = 1s$		17.5		A
f_T Transition frequency	$V_{CE}=15V$ $I_C = 2A$ $f = 10MHz$		8		MHz



BUX20

ELECTRICAL CHARACTERISTICS (continued)

Parameter		Test conditions	Min. Typ. Max.	Unit
t_{on}	Turn-on time (fig. 2)	$I_C = 50A$ $V_{CC} = 60V$	0.4 1.5	μs
t_s	Storage time (fig. 2)	$I_C = 50A$ $I_{B2} = -5A$ $V_{CC} = 60V$	0.85 1.2	μs
t_f	Fall time (fig. 2)		0.1 0.3	μs
Clamped $E_{s,b}$ Collector current (fig. 1)		$V_{clamp} = 125V$ $L = 500\mu H$	50	A

* Pulsed: pulse duration = 300 μs , duty cycle $\leq 2\%$

Safe operating areas

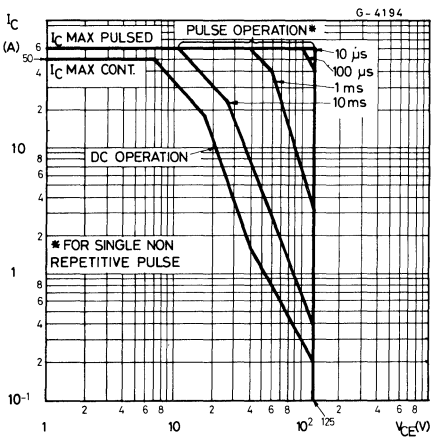

Derating curves

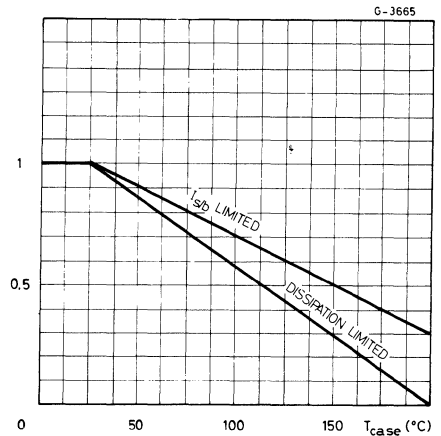



BUX20

Thermal transient response

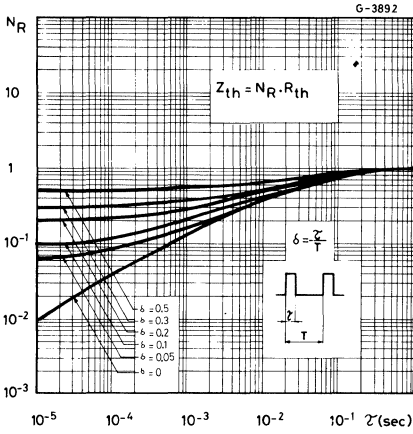

DC current gain

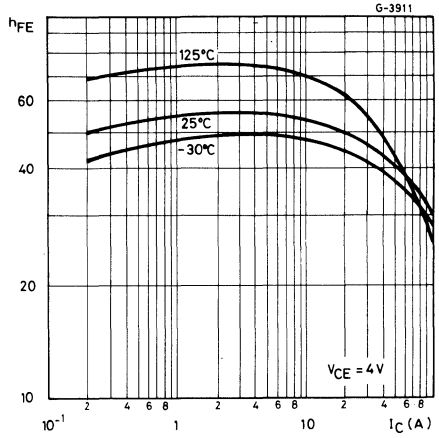

Collector-emitter saturation voltage

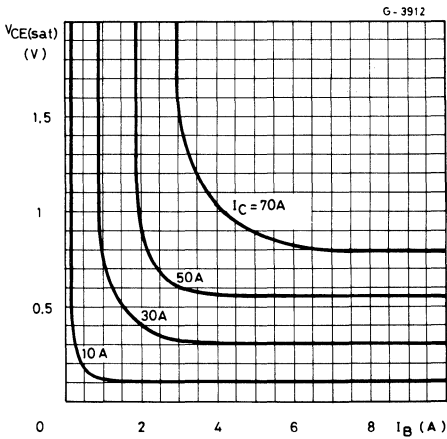

Collector-emitter saturation voltage

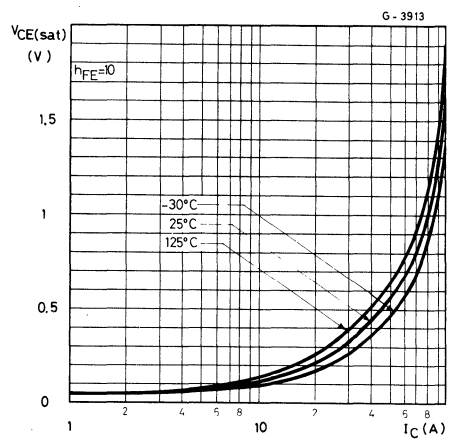



BUX20

Base-emitter saturation voltage

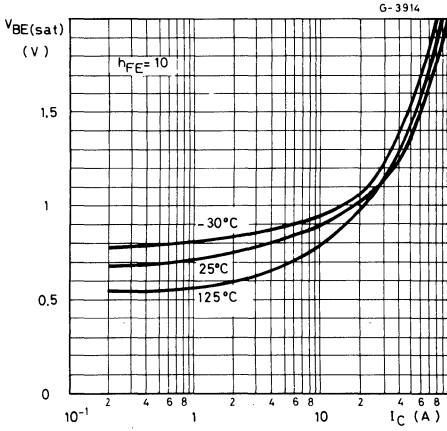

Saturated switching characteristics

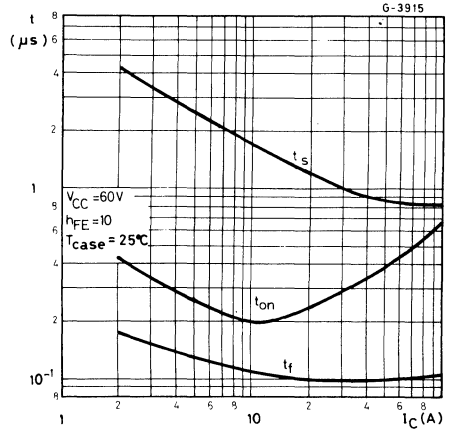

Saturated switching characteristics

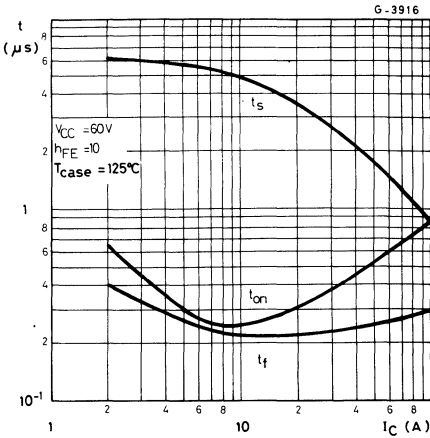

Transition frequency

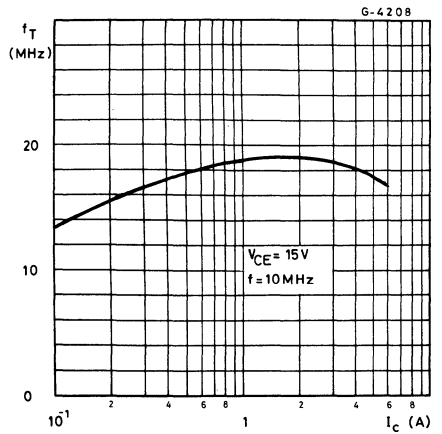

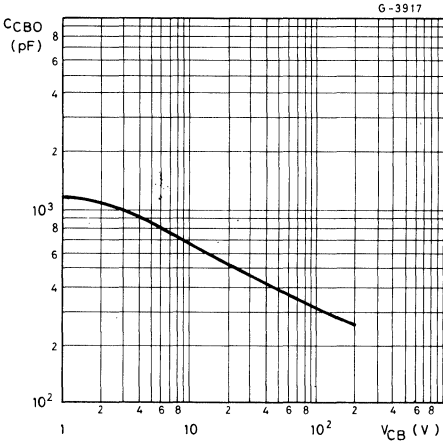
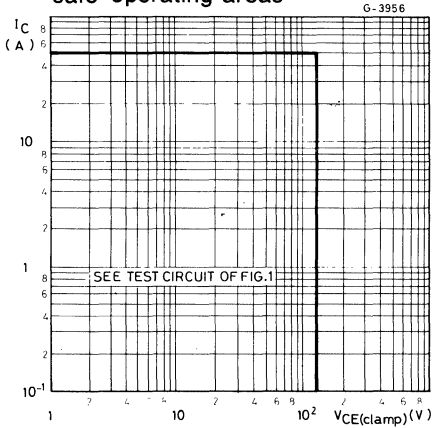
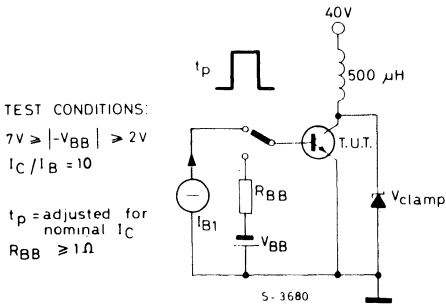
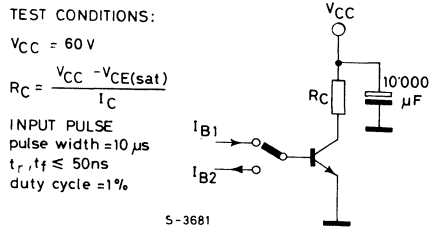
Collector-base capacitance

Clamped reverse bias safe operating areas

Fig. 1 – Clamped $E_{s,b}$ test circuit

Fig. 2 – Switching times test circuit (resistive load)



MULTIEPITAXIAL PLANAR NPN

HIGH CURRENT, HIGH SPEED, HIGH POWER TRANSISTOR

The BUX 21 is a silicon multiepitaxial planar NPN transistor in modified Jødec TO-3 metal case, intended for use in switching and linear applications in military and industrial equipment.

ABSOLUTE MAXIMUM RATINGS

V_{CBO}	Collector-base voltage ($I_E=0$)	250	V
V_{CEX}	Collector-emitter voltage ($V_{EB} = -1.5V$)	250	V
V_{CEO}	Collector-emitter voltage ($I_B=0$)	200	V
V_{EBO}	Emitter-base voltage ($I_C=0$)	7	V
I_C	Collector current	40	A
I_{CM}	Collector peak current ($t_p=10$ ms)	50	A
I_B	Base current	8	A
P_{tot}	Total power dissipation at $T_{case} \leq 25^\circ C$	350	W
T_{stg}	Storage temperature	-65 to 200	$^\circ C$
T_j	Junction temperature	200	$^\circ C$

INTERNAL SCHEMATIC DIAGRAM

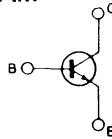

MECHANICAL DATA

Dimensions in mm

Collector connected to case

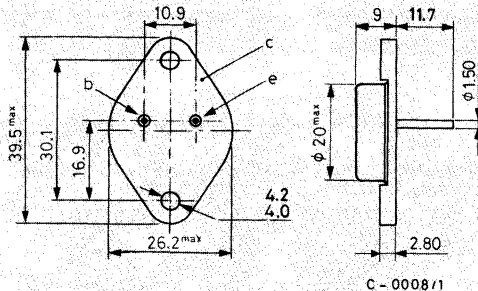

Modified TO-3

**BUX21****THERMAL DATA**

$R_{th\ j-case}$	Thermal resistance junction-case	max	0.5	°C/W
------------------	----------------------------------	-----	-----	------

ELECTRICAL CHARACTERISTICS ($T_{case} = 25^{\circ}C$ unless otherwise specified)

Parameter	Test conditions	Min.	Typ.	Max.	Unit	
I_{CEO}	Collector cutoff current ($I_B=0$)	$V_{CE}=160V$		3	mA	
I_{CEX}	Collector cutoff current	$V_{CF}=250V$ $V_{BE}=-1.5V$		3	mA	
		$T_{case}=125^{\circ}C$		12	mA	
I_{EBO}	Emitter cutoff current ($I_C=0$)	$V_{CE}=250V$ $V_{BE}=-1.5V$		1	mA	
		$V_{EB}=5V$				
$V_{CEO(sus)}$	*Collector-emitter sustaining voltage	$I_C = 200mA$		200	V	
V_{EBQ}	Emitter-base voltage ($I_C=0$)	$I_E = 50mA$		7	V	
$V_{CE(sat)}$	* Collector-emitter saturation voltage	$I_C = 12A$	$I_B = 1.2A$	0.22	0.6	V
		$I_C = 25A$	$I_B = 3A$	0.4	1.5	V
$V_{BE(sat)}$	* Base-emitter saturation voltage	$I_C = 25A$	$I_B = 3A$	1.2	1.5	V
h_{FE}	* DC current gain	$I_C = 12$	$V_{CE}=2V$	20	60	—
		$I_C = 25$	$V_{CE}=4V$	10		—
I_{sb}	Second breakdown collector current	$V_{CE}=140V$	$t = 1s$	0.15		A
		$V_{CE}=20V$	$t = 1s$	17.5		A
f_T	Transition frequency	$V_{CE}=15V$	$I_C = 2$	8		MHz
		$f = 10MHz$				



BUX21

ELECTRICAL CHARACTERISTICS (continued)

Parameter	Test conditions	Min. Typ. Max.	Unit
t_{on} Turn-on time (fig. 2)	$I_C = 25A$ $I_{B1} = 3A$ $V_{CC} = 100V$	0.24 1.2	μs
t_s Storage time (fig. 2)	$I_C = 25A$ $I_{B1} = 3A$ $I_{B2} = -3A$ $V_{CC} = 100V$	1.3 1.8	μs
t_f Fall time (fig. 2)		0.18 0.4	μs
Clamped $E_{s,b}$ Collector current (fig. 1)	$V_{clamp} = 200V$ $L = 500\mu H$	30	A

* Pulsed: pulse duration = 300 μs , duty cycle $\leq 2\%$

Safe operating areas

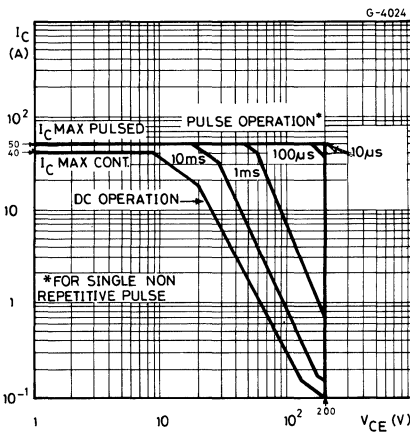

Derating curves

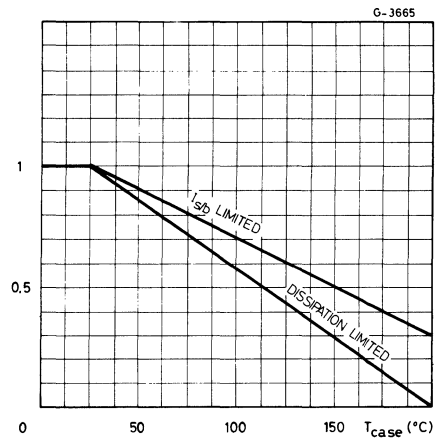



BUX21

Thermal transient response

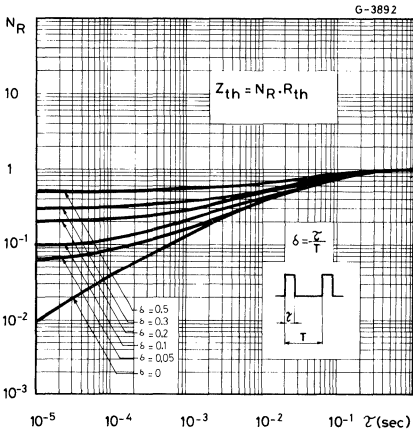

DC current gain

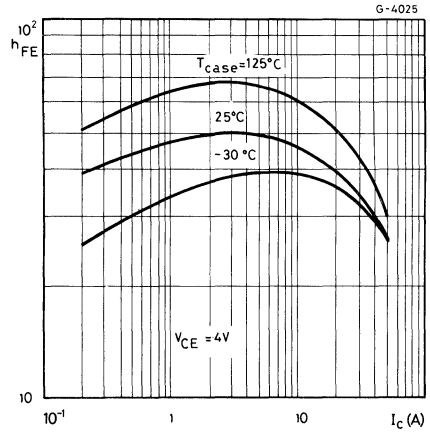

Collector-emitter saturation voltage

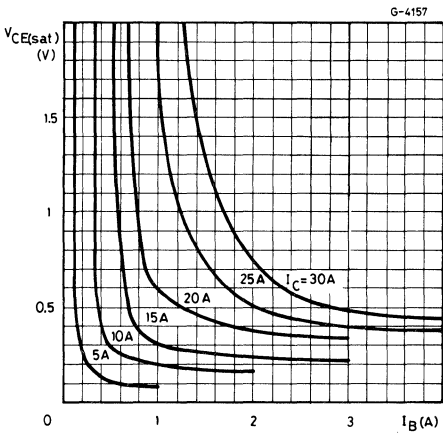

Collector-emitter saturation voltage

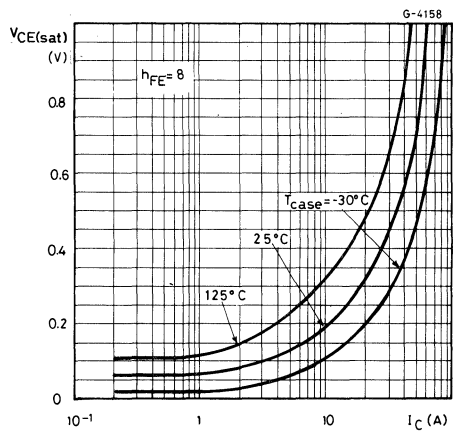

Base-emitter saturation voltage

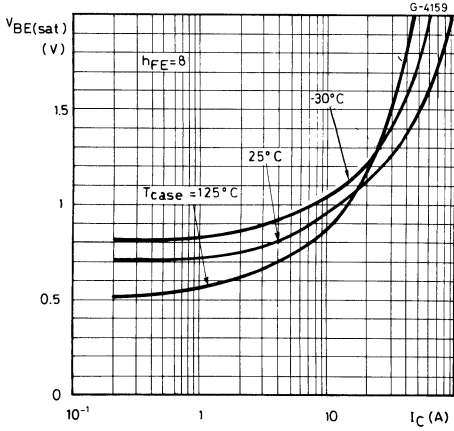

Saturated switching characteristics

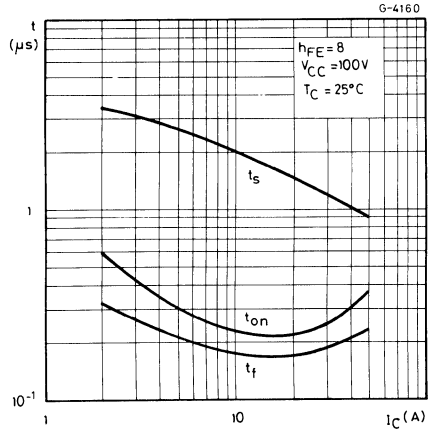

Saturated switching characteristics

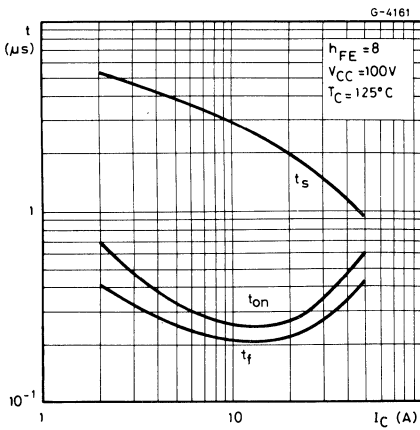

Transition frequency

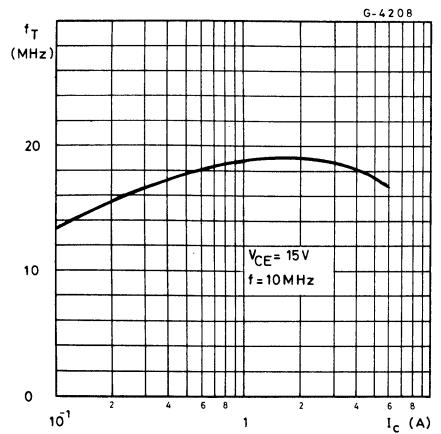

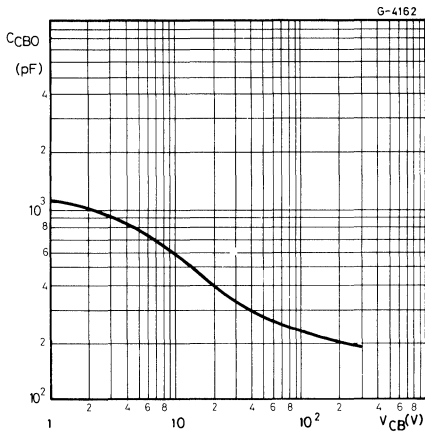
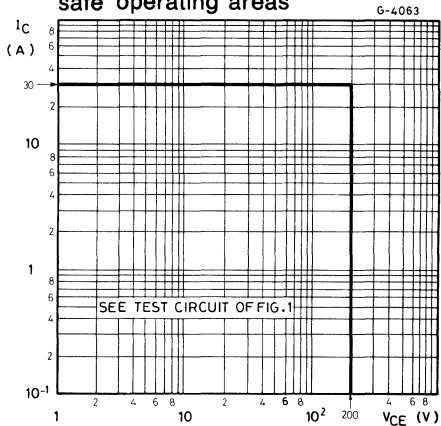
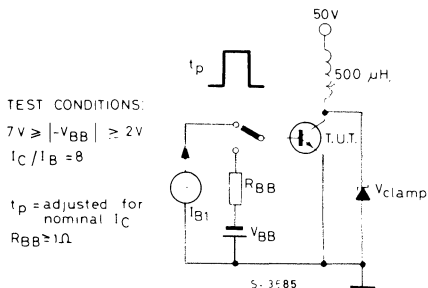
Collector-base capacitance

Clamped reverse bias safe operating areas

Fig. 1 – Clamped $E_{s/b}$ test circuit
Fig. 2 – Switching times test circuit (resistive load)

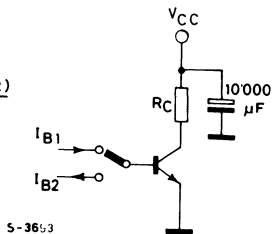
TEST CONDITIONS:
 $V_{CC} = 100V$

$$R_C = \frac{V_{CC} - V_{CE(sat)}}{I_C}$$

INPUT PULSE
 pulse width = $5 \mu s$
 $t_r, t_f \leq 50ns$
 duty cycle = 1%





BUX22

MULTIEPITAXIAL PLANAR NPN

HIGH CURRENT, HIGH SPEED, HIGH POWER TRANSISTOR

The BUX 22 is a silicon multiepitaxial planar NPN transistor in modified Jeduc TO-3 metal case, intended for use in switching and linear applications in military and industrial equipment.

ABSOLUTE MAXIMUM RATINGS

V_{CBO}	Collector-base voltage ($I_E=0$)	300	V
V_{CEX}	Collector-emitter voltage ($V_{BE}=-1.5V$)	300	V
V_{CEO}	Collector-emitter voltage ($I_B=0$)	250	V
V_{EBO}	Emitter-base voltage ($I_C=0$)	7	V
I_C	Collector current	40	A
I_{CM}	Collector peak current ($t_p=10\text{ ms}$)	50	A
I_B	Base current	8	A
P_{tot}	Total power dissipation at $T_{case} \leq 25^\circ C$	350	W
T_{stg}	Storage temperature	-65 to 200	$^\circ C$
T_j	Junction temperature	200	$^\circ C$

INTERNAL SCHEMATIC DIAGRAM

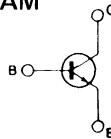

MECHANICAL DATA

Dimensions in mm

Collector connected to case

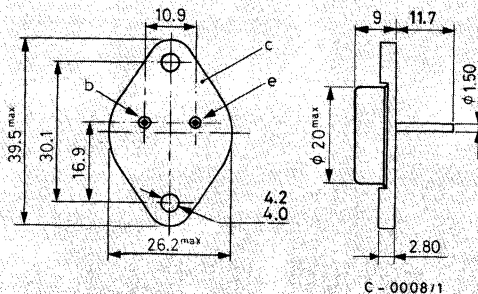

Modified TO-3

**BUX22****THERMAL DATA**

$R_{th\ j-case}$	Thermal resistance junction-case	max 0.5 °C/W
------------------	----------------------------------	--------------

ELECTRICAL CHARACTERISTICS ($T_{case} = 25^{\circ}C$ unless otherwise specified)

Parameter	Test conditions	Min. Typ. Max.	Unit
I_{CEO} Collector cutoff current ($I_B=0$)	$V_{CE}=200V$	3	mA
I_{CEX} Collector cutoff current	$V_{CE}=300V$ $V_{BE}=-1.5V$	3	mA
	$T_{case}=125^{\circ}C$ $V_{CE}=300V$ $V_{BE}=-1.5V$	12	mA
I_{EBO} Emitter cutoff current ($I_C=0$)	$V_{EB}=5V$	1	mA
$V_{CEO(sus)}$ *Collector-emitter sustaining voltage	$I_C = 200mA$	250	V
V_{EBO} Emitter-base voltage ($I_C=0$)	$I_E = 50mA$	7	V
$V_{CE(sat)}$ * Collector-emitter saturation voltage	$I_C = 10A$ $I_B = 1A$	0.2 1	V
	$I_C = 20A$ $I_B = 2.5A$	0.32 1.5	V
$V_{BE(sat)}$ * Base-emitter saturation voltage	$I_C = 20A$ $I_B = 2.5A$	1.1 1.5	V
h_{FE} * DC current gain	$I_C = 10A$ $V_{CE}=4V$	20	60
	$I_C = 20A$ $V_{CE}=4V$	10	—
$I_{s/b}$ Second breakdown collector current	$V_{CE}=140V$ $t = 1s$	0.15	A
	$V_{CE}=20V$ $t = 1s$	17.5	A
f_T Transition frequency	$I_C = 2A$ $V_{CE}=15V$ $f = 10MHz$	10	MHz



ELECTRICAL CHARACTERISTICS (continued)

Parameter		Test conditions	Min. Typ. Max.	Unit
t_{on}	Turn-on time (fig. 2)	$I_C = 20A$ $I_{B1} = 2.5A$ $V_{CC} = 100V$	0.22 1.3	μs
t_s	Storage time (fig. 2)	$I_C = 20A$ $I_{B1} = 2.5A$ $I_{B2} = -2.5A$ $V_{CC} = 100V$	1.5 2	μs
t_f	Fall time (fig. 2)		0.17 0.5	μs
Clamped $E_{s,b}$ Collector current (fig. 1)		$V_{clamp} = 250V$ $L = 500\mu H$	25	A

* Pulsed: pulse duration = 300 μs , duty cycle $\leq 2\%$

Safe operating areas

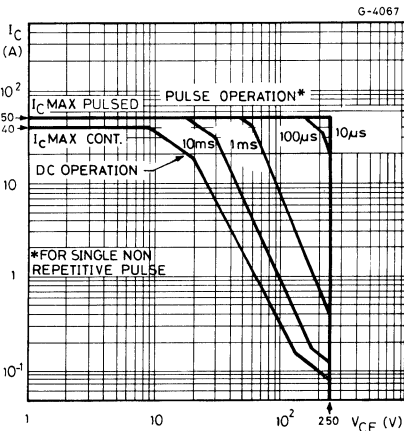

Derating curves

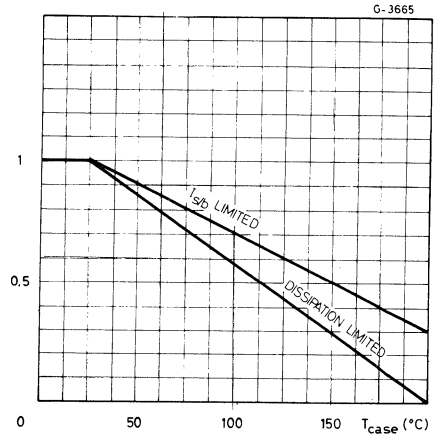



BUX22

Thermal transient response

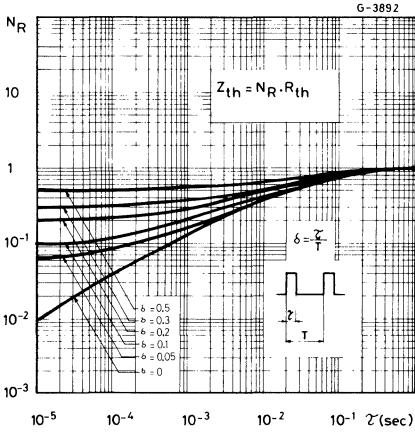

DC current gain

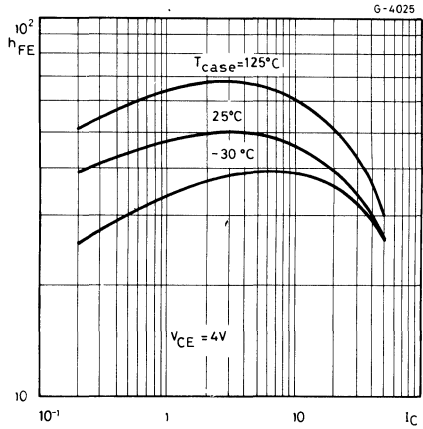

Collector-emitter saturation voltage

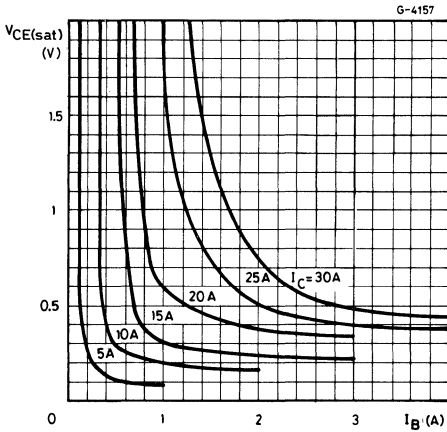

Collector-emitter saturation voltage

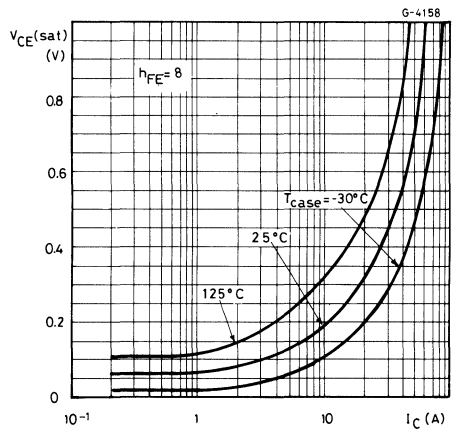

Base-emitter saturation voltage

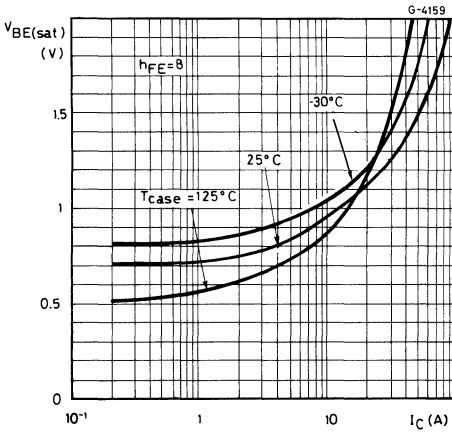

Saturated switching characteristics

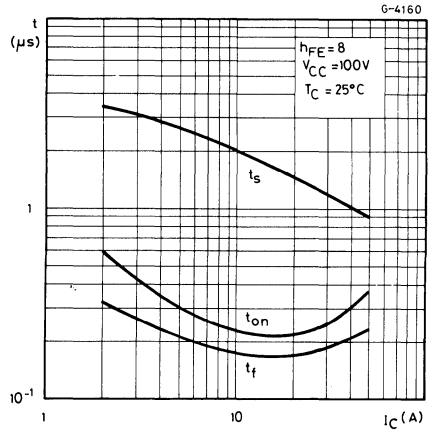

Saturated switching characteristics

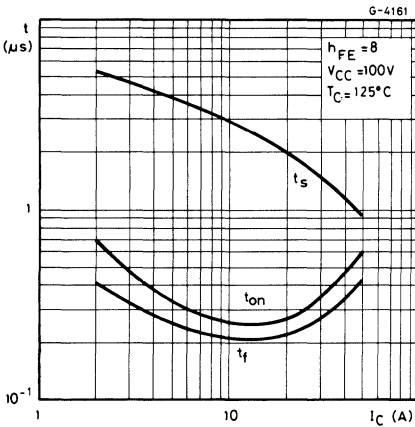

Transition frequency

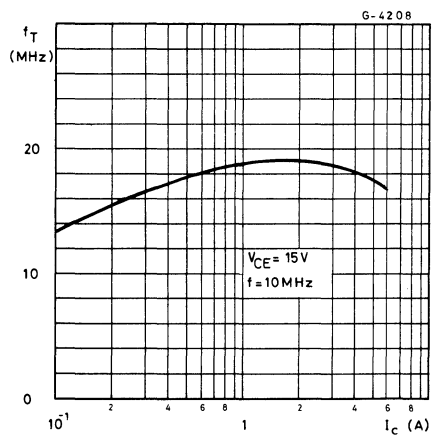



BUX22

Collector-base capacitance

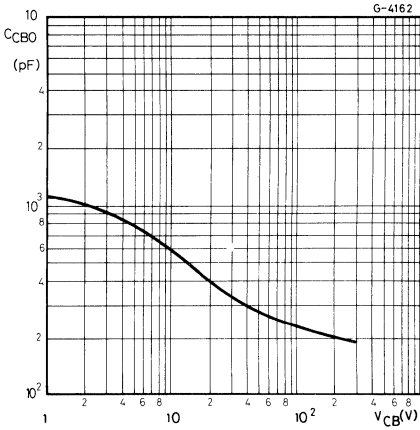

Clamped reverse bias safe operating areas

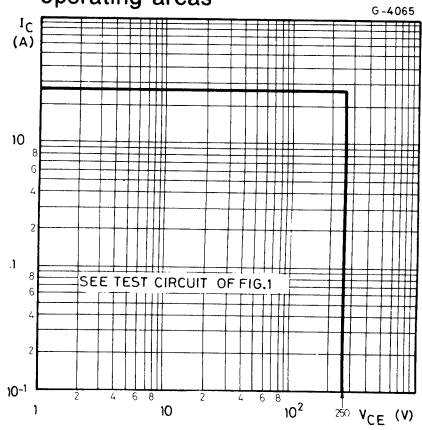

Fig. 1 — Clamped $E_{s/b}$ test circuit

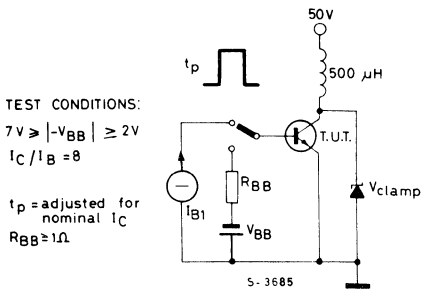
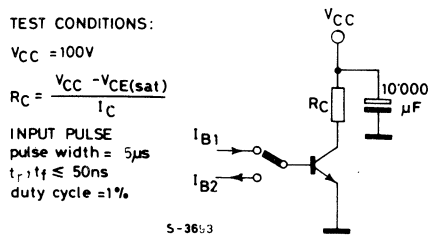

Fig. 2 — Switching times test circuit (resistive load)





MULTIEPITAXIAL PLANAR NPN

HIGH CURRENT, HIGH SPEED, HIGH POWER TRANSISTOR

The BUX 40 is a silicon multiepitaxial planar NPN transistor in Jedec TO-3 metal case, intended for use in switching and linear applications in military and industrial equipment.

ABSOLUTE MAXIMUM RATINGS

V_{CBO}	Collector-base voltage ($I_E = 0$)	160	V
V_{CEX}	Collector-emitter voltage ($V_{BE} = -1.5V$)	160	V
V_{CEO}	Collector-emitter voltage ($I_B = 0$)	125	V
V_{EBO}	Emitter-base voltage ($I_C = 0$)	7	V
I_C	Collector current	20	A
I_{CM}	Collector peak current ($t_p = 10ms$)	28	A
I_B	Base current	4	A
P_{tot}	Total power dissipation at $T_{case} \leq 25^\circ C$	120	W
T_{stg}	Storage temperature	-65 to 200	$^\circ C$
T_j	Junction temperature	200	$^\circ C$

INTERNAL SCHEMATIC DIAGRAM

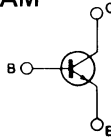

MECHANICAL DATA

Dimensions in mm

Collector connected to case

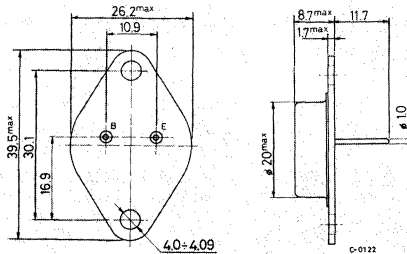

TO-3



BUX40

THERMAL DATA

$R_{th\ j-case}$	Thermal resistance junction-case	max	1.46 °C/W
------------------	----------------------------------	-----	-----------

ELECTRICAL CHARACTERISTICS ($T_{case} = 25^{\circ}C$ unless otherwise specified)

Parameter	Test conditions	Min.	Typ.	Max.	Unit	
I_{CEO}	Collector cutoff current ($I_B = 0$)	$V_{CE} = 100V$		1	mA	
I_{CEX}	Collector cutoff current	$V_{CE} = 160V$ $V_{BE} = -1.5V$		1	mA	
		$T_{case} = 125^{\circ}C$ $V_{CE} = 160V$ $V_{BE} = -1.5V$		5	mA	
I_{EBO}	Emitter-cutoff current ($I_C = 0$)	$V_{EB} = 5V$		1	mA	
$V_{CEO(sus)}$	*Collector-emitter sustaining voltage	$I_C = 200mA$		125	V	
V_{EBO}	Emitter-base voltage ($I_C = 0$)	$I_E = 50mA$		7	V	
$V_{CE(sat)}$	*Collector-emitter saturation voltage	$I_C = 10A$	$I_B = 1A$	0.6	1.2	V
		$I_C = 15A$	$I_B = 1.88 A$	0.9	1.6	V
$V_{BE(sat)}$	*Base-emitter saturation voltage	$I_C = 15A$	$I_B = 1.88A$	1.7	2	V
h_{FE}	*DC current gain	$I_C = 10A$	$V_{CE} = 4V$	15	45	—
		$I_C = 15A$	$V_{CE} = 4V$	8	—	—
$I_{s/b}$	Second breakdown collector current	$V_{CE} = 30V$	$t = 1 s$	4	A	
		$V_{CE} = 50V$	$t = 1 s$	1	A	
f_T	Transition frequency	$I_C = 1A$	$V_{CE} = 15V$	8	MHz	
		$f = 10MHz$				

* Pulsed: pulse duration = 300 μs , duty cycle $\leq 2\%$.

ELECTRICAL CHARACTERISTICS (continued)

Parameter	Test conditions	Min. Typ. Max.	Unit
t_{on} Turn-on time (see fig. 2)	$I_C = 15A$ $I_{B1} = 1.88A$ $V_{CC} = 30V$	0.35 1.2	μs
t_s Storage time (see fig. 2)	$I_C = 15A$ $I_{B1} = -I_{B2} = 1.88A$ $V_{CC} = 30V$	0.85 1	μs
t_f Fall time (see fig. 2)		0.14 0.4	μs
Clamped $E_{s/b}$ Collector current (see fig. 1)	$V_{CLAMP} = 125V$ $L = 500\mu H$	15	A

Safe operating areas

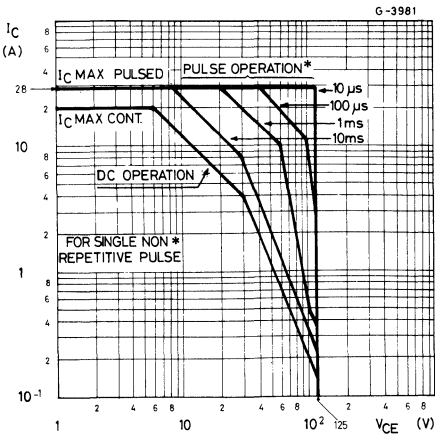

Derating curves

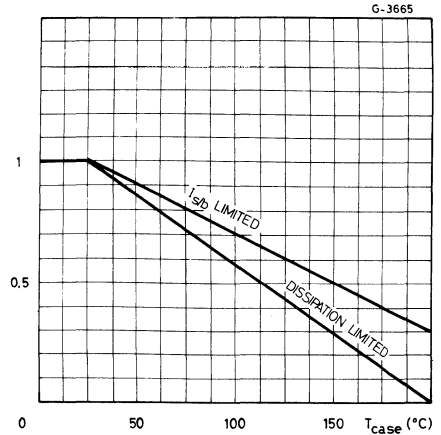

Thermal transient response

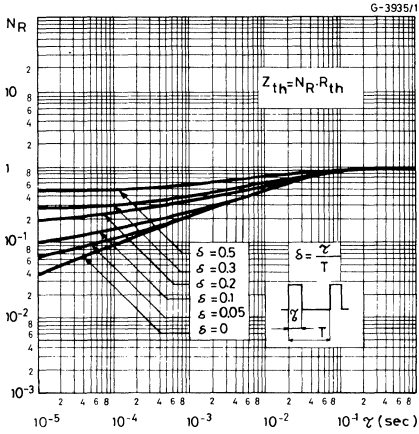

DC current gain

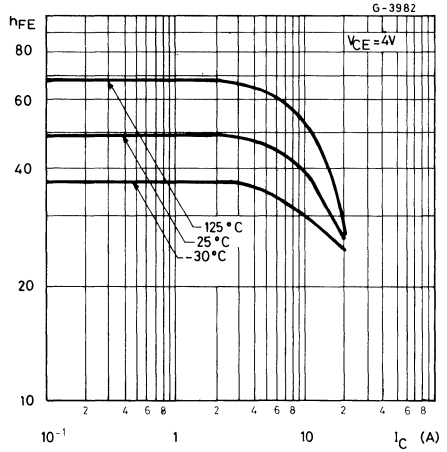

Collector-emitter saturation voltage

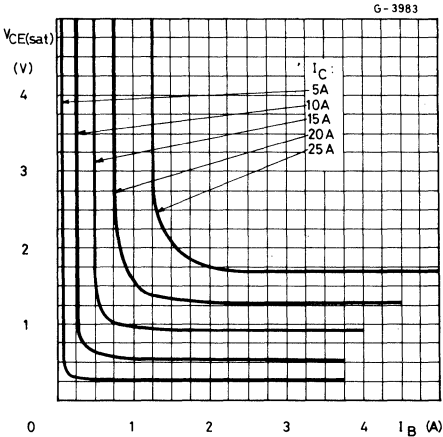

Collector-emitter saturation voltage

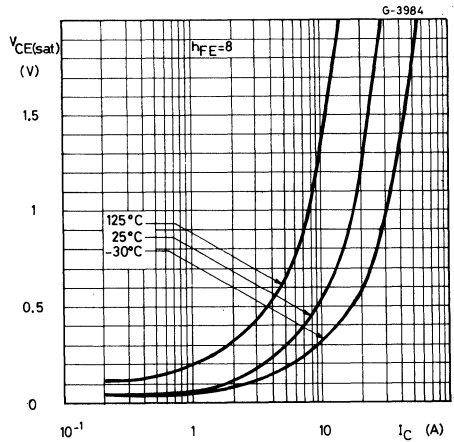



Base-emitter saturation voltage

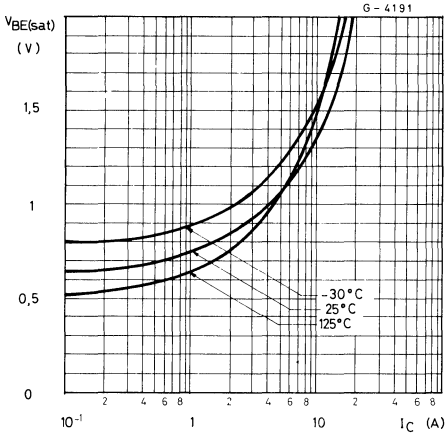

Saturated switching characteristics

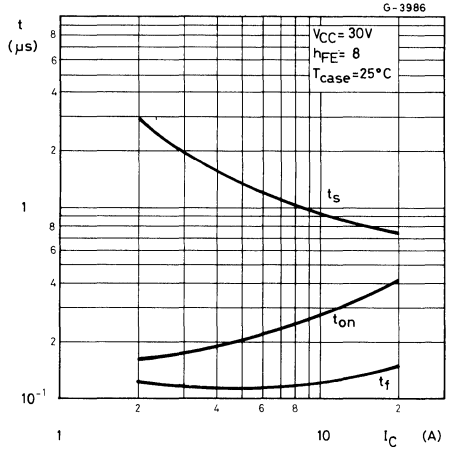

Saturated switching characteristics

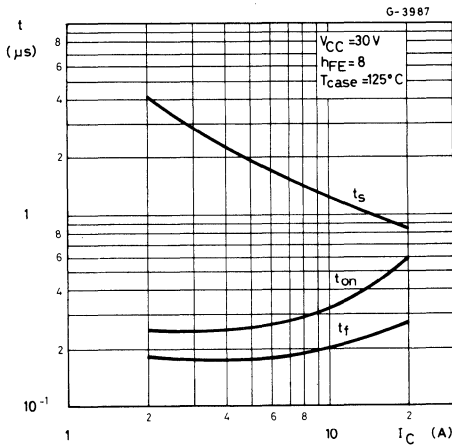

Transition frequency

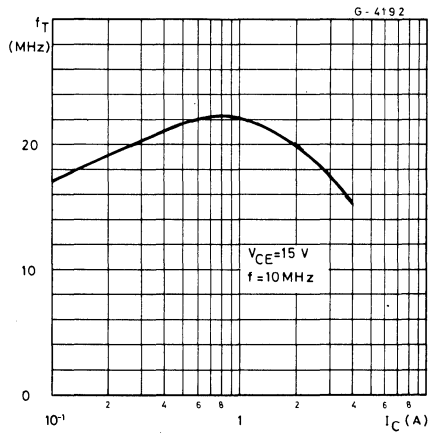

Collector-base capacitance

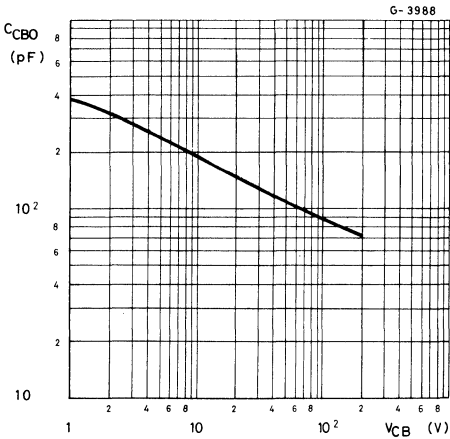

Clamped reverse bias safe operating areas

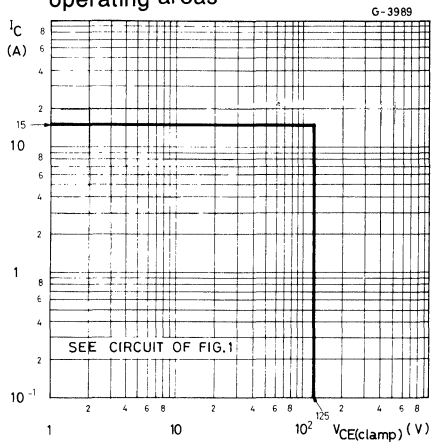

Fig. 1 – Clamped $E_{s/b}$ test circuit

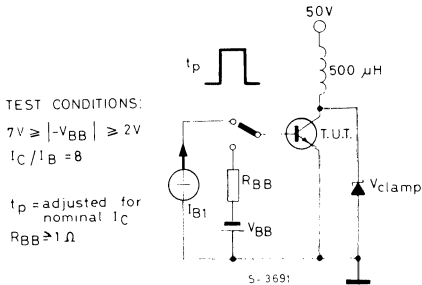
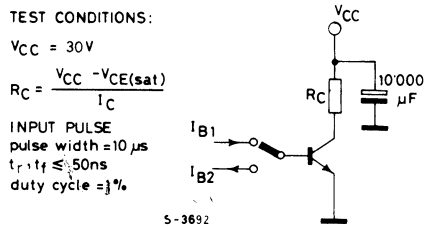
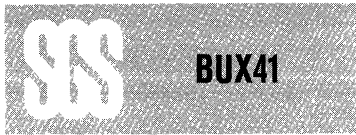

Fig. 2 – Switching times test circuit (resistive load)





MULTIEPITAXIAL PLANAR NPN

HIGH CURRENT, HIGH SPEED, HIGH POWER TRANSISTOR

The BUX 41 is a silicon multiepitaxial planar NPN transistor in Jedec TO-3 metal case, intended for use in switching and linear applications in military and industrial equipment.

ABSOLUTE MAXIMUM RATINGS

V_{CBO}	Collector-base voltage ($I_E=0$)	250	V
V_{CEX}	Collector-emitter voltage ($V_{BE}=-1.5V$)	250	V
V_{CEO}	Collector-emitter voltage ($I_B=0$)	200	V
V_{EBO}	Emitter-base voltage ($I_C=0$)	7	V
I_C	Collector current	15	A
I_{CM}	Collector peak current ($t_p=10$ ms)	20	A
I_B	Base current	3	A
P_{tot}	Total power dissipation at $T_{case} \leq 25^\circ C$	120	W
T_{stg}	Storage temperature	-65 to 200	$^\circ C$
T_j	Junction temperature	200	$^\circ C$

INTERNAL SCHEMATIC DIAGRAM

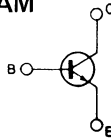

MECHANICAL DATA

Dimensions in mm

Collector connected to case

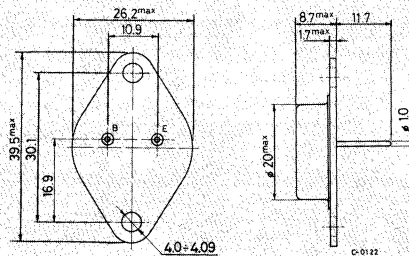

TO-3



BUX41

THERMAL DATA

$R_{th\ j-case}$	Thermal resistance junction-case	max 1.46 °C/W
------------------	----------------------------------	---------------

ELECTRICAL CHARACTERISTICS ($T_{case} = 25^{\circ}C$ unless otherwise specified)

Parameter	Test conditions	Min.	Typ.	Max.	Unit	
I_{CEO}	Collector cutoff current ($I_B = 0$)	$V_{CE} = 160V$			1	mA
I_{CEX}	Collector cutoff current	$V_{CE} = 250V \quad V_{BE} = -1.5V$			1	mA
		$T_{case} = 125^{\circ}C$ $V_{CE} = 250V \quad V_{BE} = -1.5V$			5	mA
I_{EBO}	Emitter cutoff current ($I_C = 0$)	$V_{EB} = 5V$			1	mA
$V_{CEO(sus)}$	*Collector-emitter sustaining voltage	$I_C = 200mA$			200	V
V_{EBO}	Emitter-base voltage ($I_C = 0$)	$I_E = 50mA$			7	V
$V_{CE(sat)}$	*Collector-emitter saturation voltage	$I_C = 5A$	$I_B = 0.5A$	0.38	1.2	V
		$I_C = 8A$	$I_B = 1A$	0.6	1.6	V
$V_{BE(sat)}$	*Base-emitter saturation voltage	$I_C = 8A$	$I_B = 1A$	1.35	2	V
h_{FE}	*DC current gain	$I_C = 5A$	$V_{CE} = 4V$	15	45	—
		$I_C = 8A$	$V_{CE} = 4V$	8	—	—
$I_{s,b}$	Second breakdown collector current	$V_{CE} = 30V$	$t = 1s$	4		A
		$V_{CE} = 135V$	$t = 1s$	0.15		A
f_t	Transition frequency	$I_C = 1A$	$V_{CE} = 15V$	8		MHz
		$f = 10MHz$				

ELECTRICAL CHARACTERISTICS (continued)

Parameter	Test conditions	Min. Typ. Max.	Unit
t_{on} Turn-on time (fig. 2)	$I_C = 8A$ $I_{B1} = 1A$ $V_{CC} = 150V$	0.28 1	μs
t_s Storage time (fig. 2)	$I_C = 8A^*$ $I_{B1} = 1A$ $I_{B2} = -1A$ $V_{CC} = 150V$	1.2 1.7	μs
t_f Fall time (fig. 2)		0.25 0.8	μs
Clamped $E_{s/b}$ Collector current (fig. 1)	$V_{clamp} = 200V$ $L = 500\mu H$	8	A

* Pulsed: pulse duration = 300 μs , duty cycle $\leq 2\%$

Safe operating areas

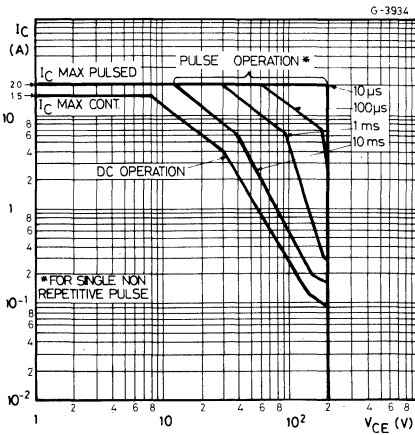

Derating curves

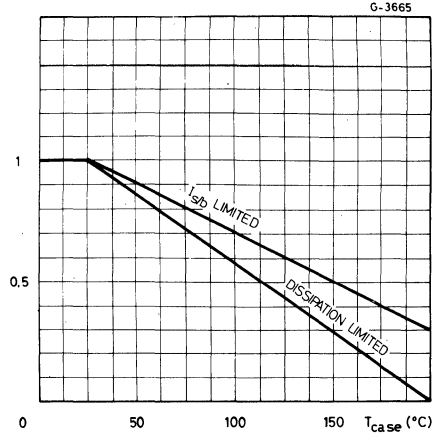



BUX41

Thermal transient response

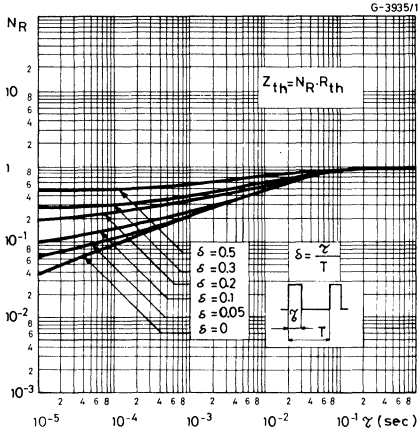

DC current gain

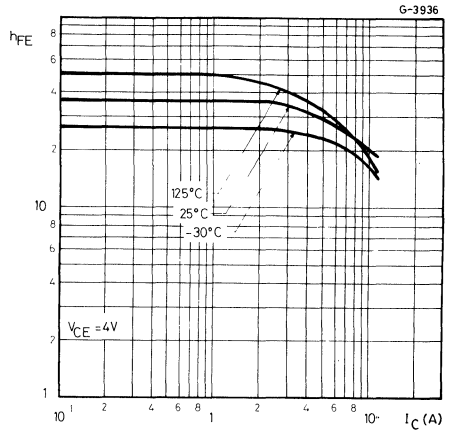

Collector-emitter saturation voltage

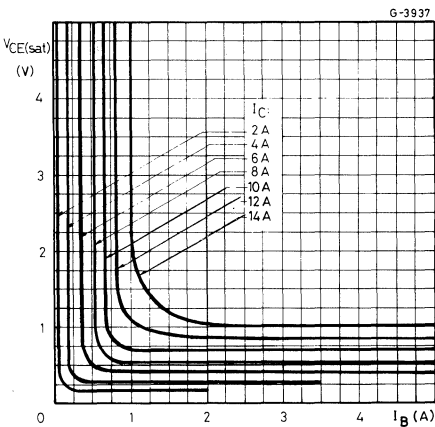

Collector-emitter saturation voltage

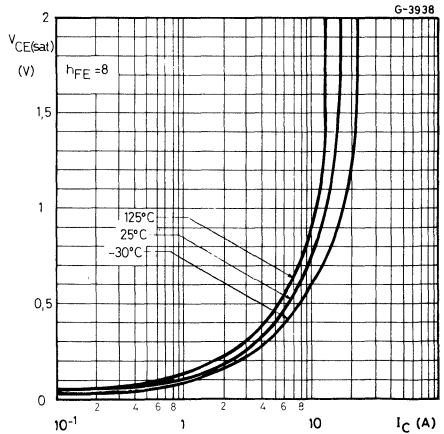

Base-emitter saturation voltage

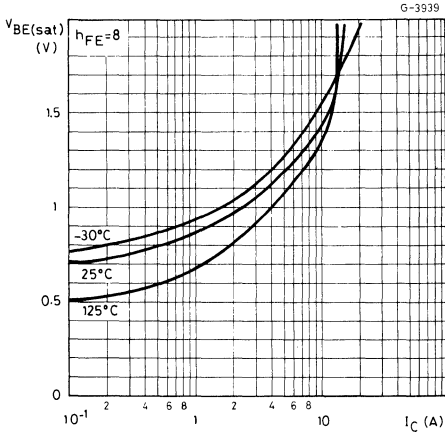

Saturated switching characteristics

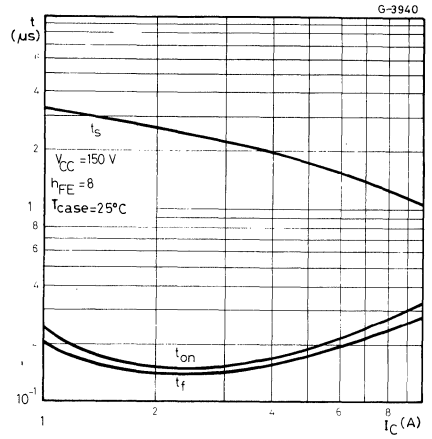

Saturated switching characteristics

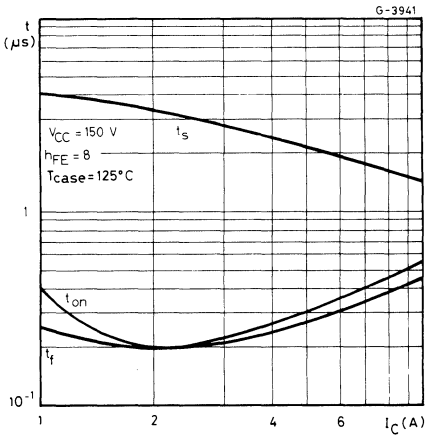

Transition frequency

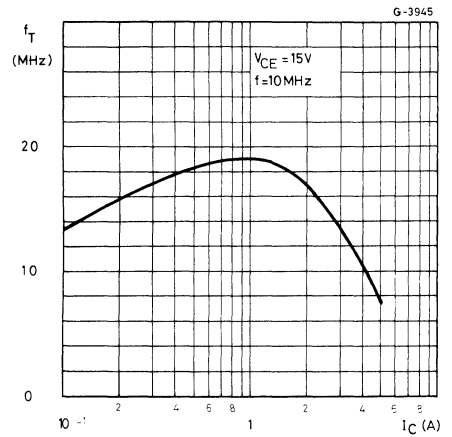

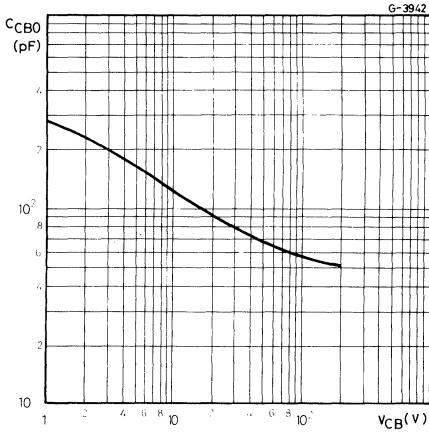
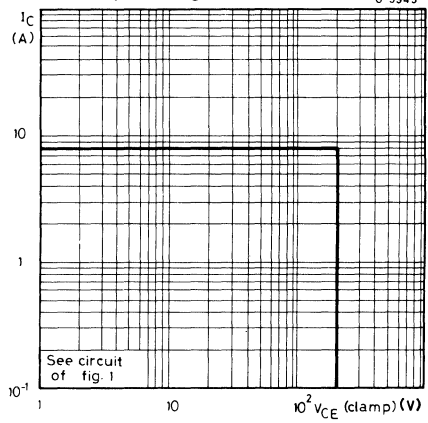
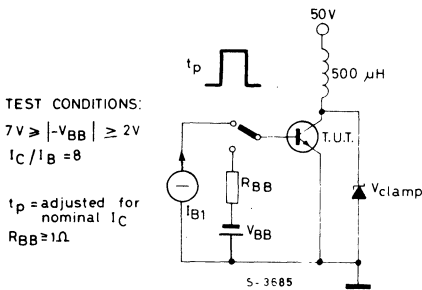
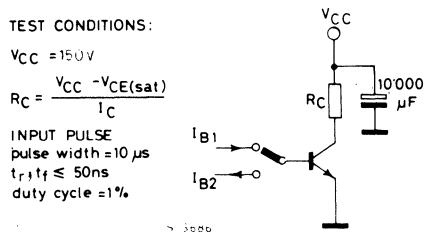
Collector-base capacitance

Clamped reverse bias safe operating area

Fig. 1 — Clamped $E_{s,b}$ test circuit

Fig. 2 — Switching times test circuit (resistive load)



MULTIEPITAXIAL PLANAR NPN

HIGH CURRENT, HIGH SPEED, HIGH POWER TRANSISTOR

The BUX 41N is a silicon multiepitaxial planar NPN transistor in Jedec TO-3 metal case intended for use in switching and linear applications in military and industrial equipment.

ABSOLUTE MAXIMUM RATINGS

V_{CBO}	Collector-base voltage ($I_E=0$)	220	V
V_{CEX}	Collector-emitter voltage ($V_{BE}=-1.5V$)	220	V
V_{CEO}	Collector-emitter voltage ($I_B=0$)	160	V
V_{EBO}	Emitter-base voltage ($I_C=0$)	7	V
I_C	Collector current	18	A
I_{CM}	Collector peak current ($t_p=10$ ms)	25	A
I_B	Base current	3.6	A
P_{tot}	Total power dissipation at $T_{case} \leq 25^\circ C$	120	W
T_{stg}	Storage temperature	-65 to 200	$^\circ C$
T_j	Junction temperature	200	$^\circ C$

INTERNAL SCHEMATIC DIAGRAM

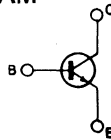

MECHANICAL DATA

Dimensions in mm

Collector connected to case

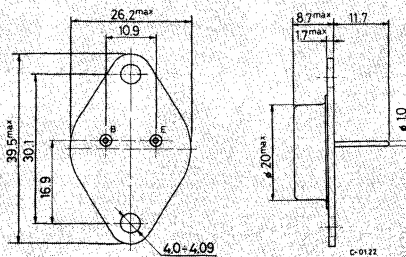

TO-3



BUX41N

THERMAL DATA

$R_{th\ j-case}$	Thermal resistance junction-case	max	1.46	°C/W
------------------	----------------------------------	-----	------	------

ELECTRICAL CHARACTERISTICS ($T_{case} = 25^{\circ}C$ unless otherwise specified)

Parameter	Test conditions	Min.	Typ.	Max.	Unit	
I_{CEO}	Collector cutoff current ($I_B=0$)	$V_{CE}=130V$		1	mA	
I_{CEX}	Collector cutoff current	$V_{CE}=220V$ $V_{BE}=-1.5V$		1	mA	
		$T_{case}=125^{\circ}C$ $V_{CE}=220V$ $V_{BE}=-1.5V$		5	mA	
I_{EBO}	Emitter cutoff current ($I_C=0$)	$V_{EB}=5V$		1	mA	
$V_{CEO(sus)}$	*Collector-emitter sustaining voltage	$I_C = 200mA$		160	V	
V_{EBO}	Emitter-base voltage ($I_C = 0$)	$I_E = 50mA$		7	V	
$V_{CE(sat)}$	* Collector-emitter saturation voltage	$I_C = 8A$	$I_B = 0.8A$	0.5	1.2	V
		$I_C = 12A$	$I_B = 1.5A$	0.75	1.6	V
$V_{BE(sat)}$	* Base-emitter saturation voltage	$I_C = 12A$	$I_B = 1.5A$	1.5	2	V
h_{FE}	* DC current gain	$I_C = 8A$	$V_{CE}=4V$	15	45	—
		$I_C = 12A$	$V_{CE}=4V$	8	—	—
$I_{s,b}$	Second breakdown collector current	$V_{CE}=30V$	$t = 1s$	4	A	
		$V_{CE}=100V$	$t = 1s$	0.27	A	
f_T	Transition frequency	$I_C = 1A$	$V_{CE}=15V$	8	MHz	
		$f_c = 10MHz$				

ELECTRICAL CHARACTERISTICS (continued)

Parameter	Test conditions	Min. Typ. Max.	Unit
t_{on} Turn-on time (fig. 2)	$I_C = 12A$ $I_{B1} = 1.5A$ $V_{CC} = 30V$	0.35 1.3	μs
t_s Storage time (fig. 2)	$I_C = 12A$ $I_{B1} = -I_{B2} = 1.5A$ $V_{CC} = 30V$	0.85 1.5	μs
t_f Fall time (fig. 2)		0.14 0.8	μs
Clamped $E_{s/b}$ Collector current (fig. 1)	$V_{CLAMP} = 160V$ $L = 500\mu H$	12	A

* Pulsed: pulse duration = 300 μs , duty cycle $\leq 2\%$

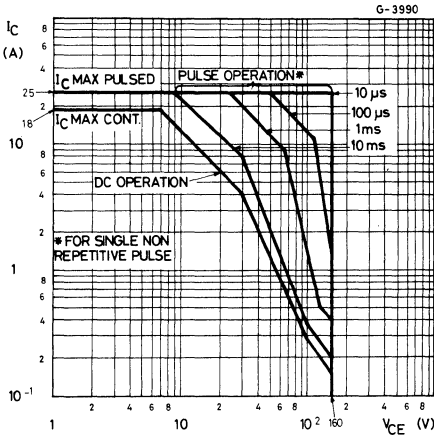
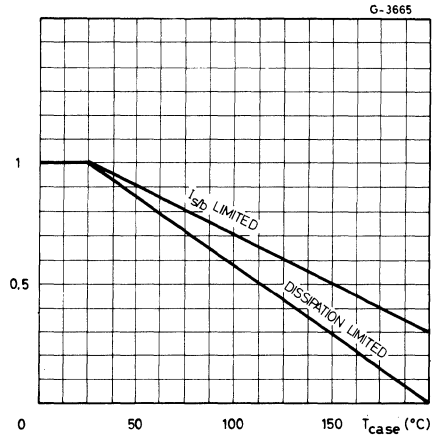
Safe operating areas

Derating curves

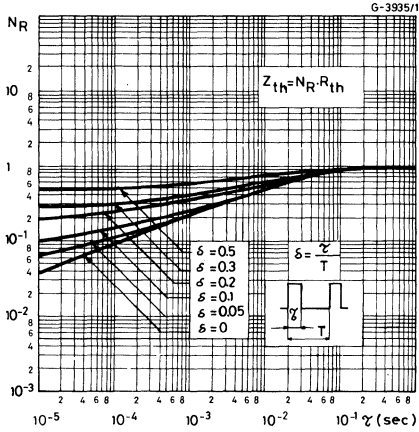

BUX41N

Thermal transient response



DC current gain

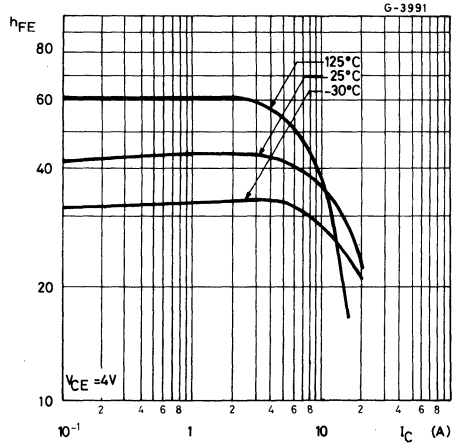

Collector-emitter saturation voltage

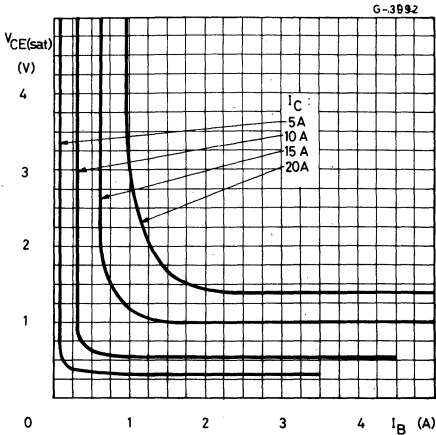

Collector-emitter saturation voltage

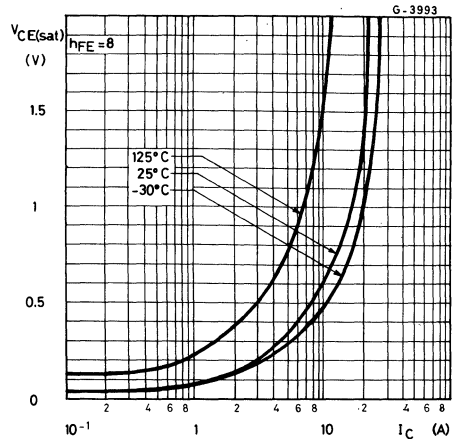

Base-emitter saturation voltage

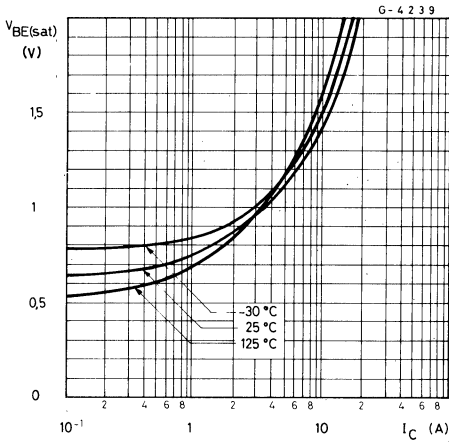

Saturated switching characteristics

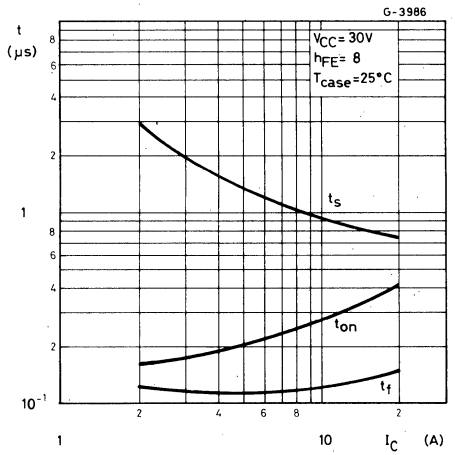

Saturated switching characteristics

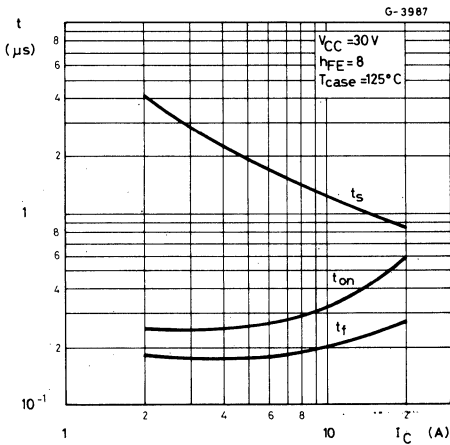

Transition frequency

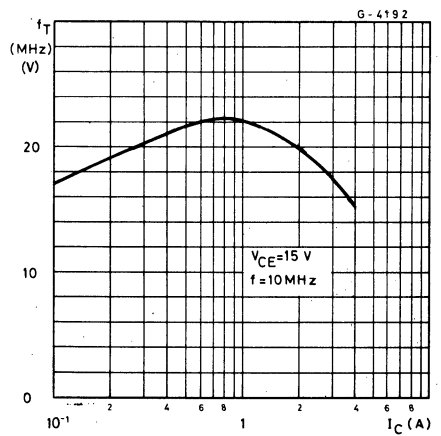

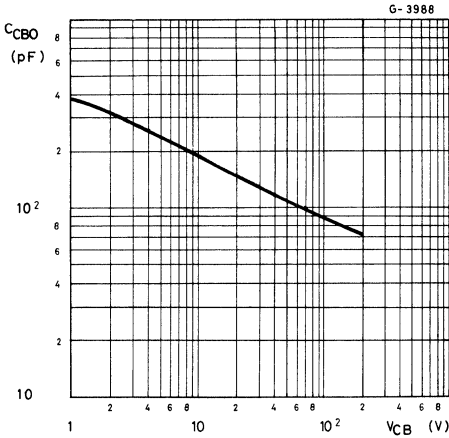
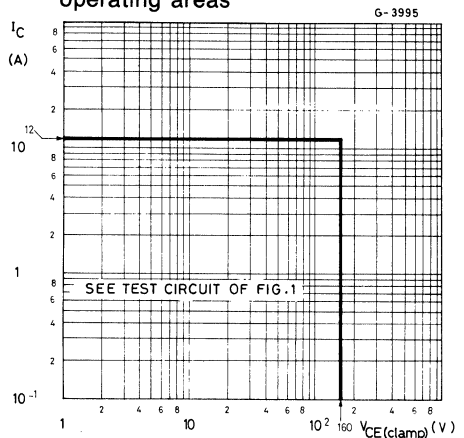
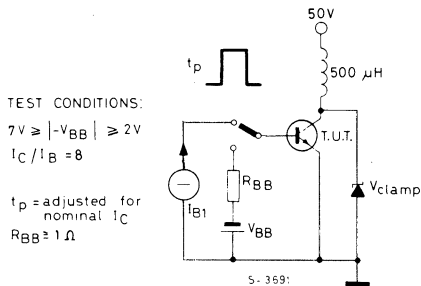
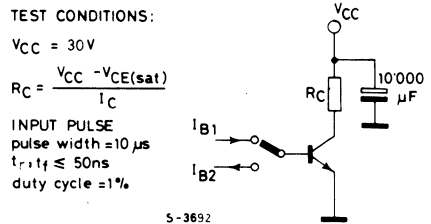
Collector-base capacitance

Clamped reverse bias safe operating areas

Fig. 1 — Clamped $E_{s,b}$ test circuit

Fig. 2 — Switching times test circuit (resistive load)



MULTIEPITAXIAL PLANAR NPN

HIGH CURRENT, HIGH SPEED, HIGH POWER TRANSISTOR

The BUX 42 is a silicon multiepitaxial planar NPN transistor in Jødec TO-3 metal case, intended for use in switching and linear applications in military and industrial equipment.

ABSOLUTE MAXIMUM RATINGS

V_{CBO}	Collector-base voltage ($I_E=0$)	300	V
V_{CEX}	Collector-emitter voltage ($V_{BE}=-1.5V$)	300	V
V_{CEO}	Collector-emitter voltage ($I_B=0$)	250	V
V_{EBO}	Emitter-base voltage ($I_C=0$)	7	V
I_C	Collector current	12	A
I_{CM}	Collector peak current ($t_p=10$ ms)	15	A
I_B	Base current	2.4	A
P_{tot}	Total power dissipation at $T_{case} \leq 25^\circ C$	120	W
T_{stg}	Storage temperature	-65 to 200	$^\circ C$
T_j	Junction temperature	200	$^\circ C$

INTERNAL SCHEMATIC DIAGRAM

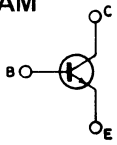

MECHANICAL DATA

Dimensions in mm

Collector connected to case

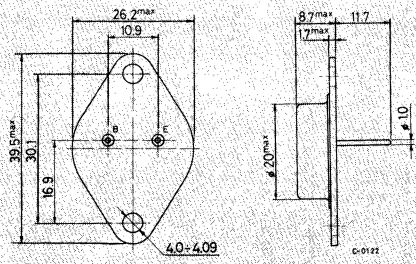

TO-3



BUX42

THERMAL DATA

$R_{th\ j-case}$	Thermal resistance junction-case	max 1.46 °C/W
------------------	----------------------------------	---------------

ELECTRICAL CHARACTERISTICS ($T_{case} = 25^{\circ}C$ unless otherwise specified)

Parameter	Test conditions	Min.	Typ.	Max.	Unit	
I_{CEO}	Collector cutoff current ($I_B = 0$)	$V_{CE} = 200V$		1	mA	
I_{CEX}	Collector cutoff current	$V_{CE} = 300V$ $V_{BE} = -1.5V$		1	mA	
		$T_{case} = 125^{\circ}C$ $V_{CE} = 300V$ $V_{BE} = -1.5V$		5	mA	
I_{EBO}	Emitter cutoff current ($I_C = 0$)	$V_{EB} = 5V$		1	mA	
$V_{CEO(sus)}$	*Collector-emitter sustaining voltage	$I_C = 200mA$		250	V	
V_{EBO}	Emitter-base voltage ($I_C = 0$)	$I_E = 50mA$		7	V	
$V_{CE(sat)}$	*Collector-emitter saturation voltage	$I_C = 4A$	$I_B = 0.4A$	0.33	1.2	V
		$I_C = 6A$	$I_B = 0.75A$	0.45	1.6	V
$V_{BE(sat)}$	*Base-emitter saturation voltage	$I_C = 6A$	$I_B = 0.75A$	1.23	2	V
h_{FE}	*DC current gain	$I_C = 4A$	$V_{CE} = 4V$	15	45	—
		$I_C = 6A$	$V_{CE} = 4V$	8	—	—
$I_{s/b}$	Second breakdown collector current	$V_{CE} = 135V$	$t = 1s$	0.15	A	
		$V_{CE} = 30V$	$t = 1s$	4	A	
f_T	Transition frequency	$I_C = 1A$ $f = 10MHz$	$V_{CE} = 15V$	8	MHz	

ELECTRICAL CHARACTERISTICS (continued)

Parameter		Test conditions	Min. Typ. Max.	Unit
t_{on}	Turn-on time (fig. 2)	$I_C = 6A$ $I_{B1} = 0.75A$ $V_{CC} = 150V$	0.23 1	μs
t_s	Storage time (fig. 2)	$I_C = 6A$ $I_{B1} = 0.75A$ $I_{B2} = -0.75A$ $V_{CC} = 150V$	1.5 2	μs
t_f	Fall time (fig. 2)		0.2 1.2	μs
Clamped $E_{s,b}$ Collector current (fig. 1)		$V_{clamp} = 250V$ $L = 500\mu H$	6	A

* Pulsed: pulse duration = 300 μs , duty cycle $\leq 2\%$

Safe operating areas

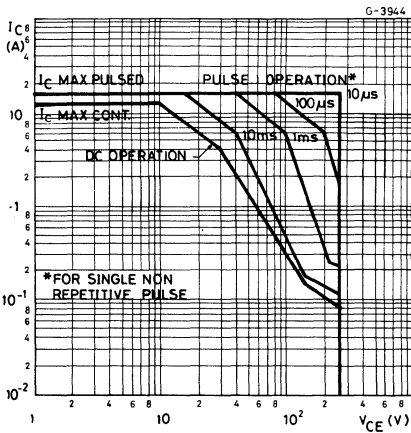

Derating curves

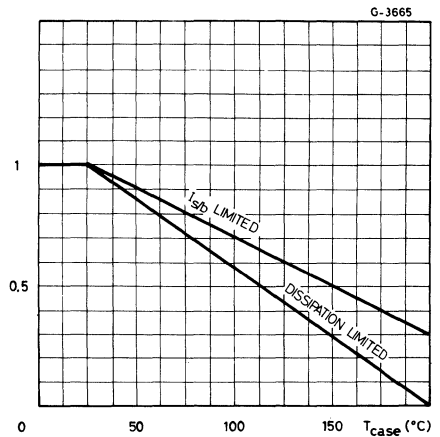



BUX42

Thermal transient response

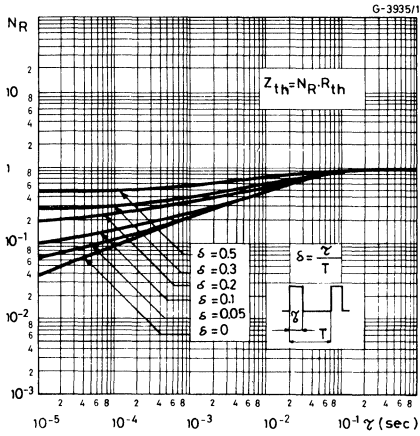

DC current gain

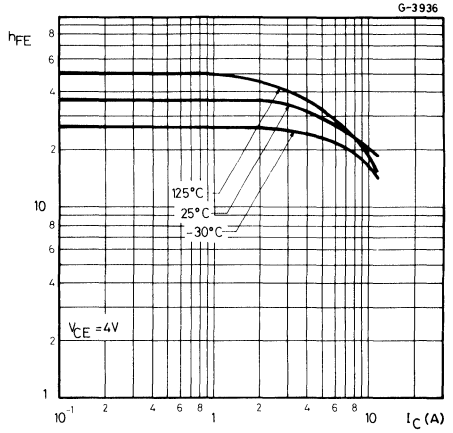

Collector-emitter saturation voltage

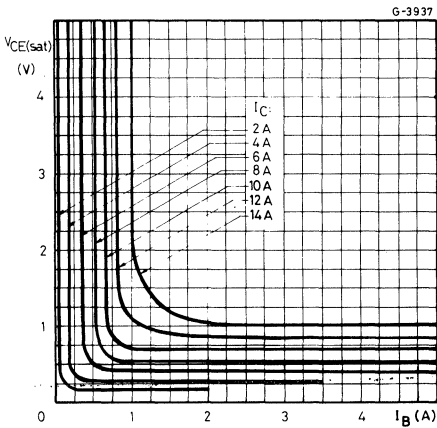

Collector-emitter saturation voltage

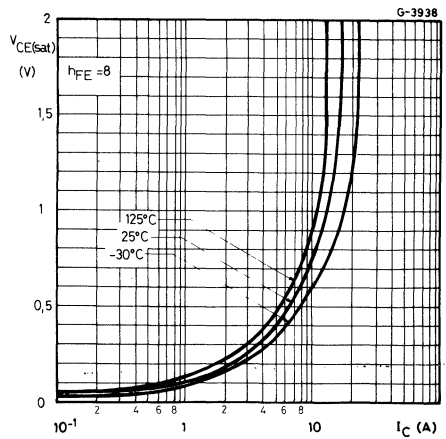



Base-emitter saturation voltage

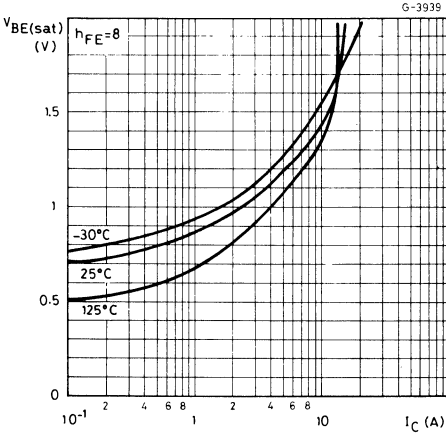

Saturated switching characteristics

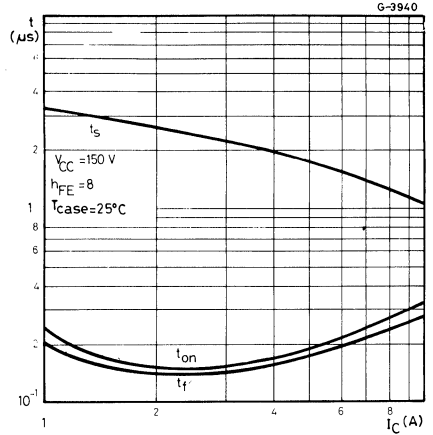

Saturated switching characteristics

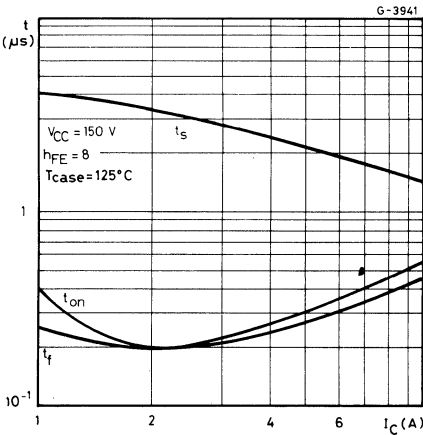

Transition frequency

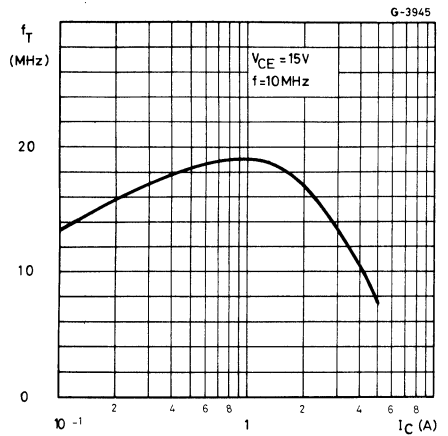

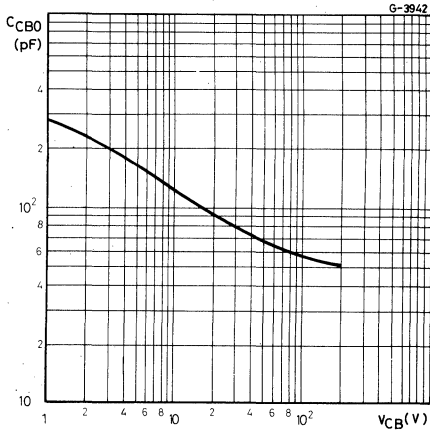
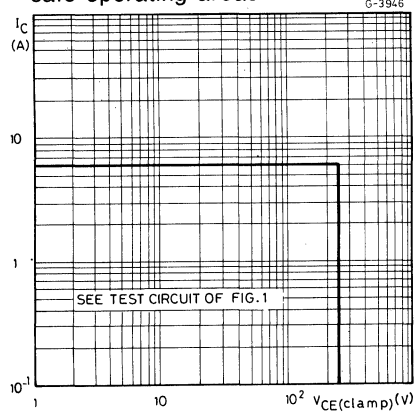
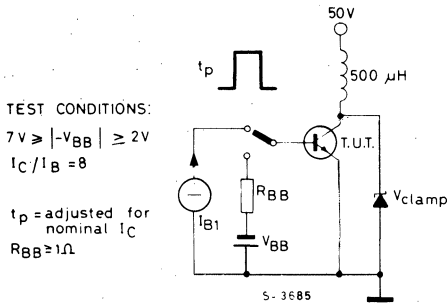
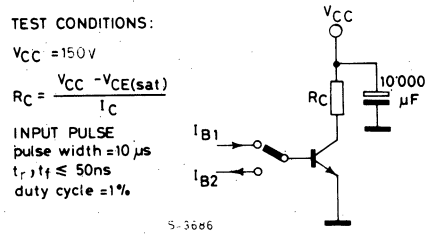
Collector-base capacitance

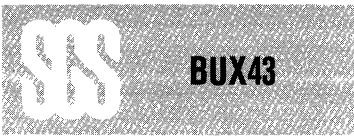
Clamped reverse bias safe operating areas

Fig. 1 – Clamped $E_{s/b}$ test circuit

Fig. 2 – Switching times test circuit (resistive load)



MULTIEPITAXIAL MESA NPN

HIGH VOLTAGE POWER SWITCH

The BUX 43 is a silicon multi-epitaxial mesa NPN transistor in Jedec TO-3 metal case, intended for high voltage, fast switching applications.

ABSOLUTE MAXIMUM RATINGS

V_{CES}	Collector-emitter voltage ($V_{BE} = 0$)	400	V
V_{CER}	Collector-emitter voltage ($R_{BE} \leq 100\Omega$)	360	V
V_{CEO}	Collector-emitter voltage ($I_B = 0$)	325	V
V_{EBO}	Emitter-base voltage ($I_C = 0$)	7	V
I_C	Collector current	10	A
I_{CM}	Collector peak current ($t_p \leq 10ms$)	12	A
I_B	Base current	2	A
P_{tot}	Total power dissipation at $T_{case} \leq 25^\circ C$	120	W
T_{stg}	Storage temperature	-65 to 200	$^\circ C$
T_j	Junction temperature	200	$^\circ C$

INTERNAL SCHEMATIC DIAGRAM

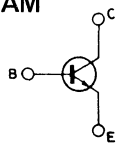

MECHANICAL DATA

Dimensions in mm

Collector connected to case

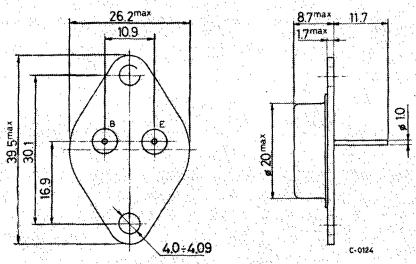

TO-3

**BUX43****THERMAL DATA**

$R_{th\ j-case}$	Thermal resistance junction-case	max 1.46 °C/W
------------------	----------------------------------	---------------

ELECTRICAL CHARACTERISTICS ($T_{case} = 25^{\circ}C$ unless otherwise specified)

Parameter	Test conditions	Min.	Typ.	Max.	Unit
I_{CES} Collector cutoff current ($V_{BE} = 0$)	$V_{CE} = 400V$			1	mA
	$V_{CE} = 400V$ $T_{case} = 125^{\circ}C$			5	mA
I_{CEO} Collector cutoff current ($I_B = 0$)	$V_{CE} = 260V$			1	mA
I_{EBO} Emitter cutoff current ($I_C = 0$)	$V_{EB} = 7V$			1	mA
$V_{CEO(sus)}$ * Collector-emitter sustaining voltage ($I_B = 0$)	$I_C = 100mA$	325			V
$V_{CE(sat)}$ * Collector-emitter saturation voltage	$I_C = 3A$ $I_B = 0.375A$			1	V
	$I_C = 5A$ $I_B = 1A$			1.6	V
$V_{BE(sat)}$ * Base-emitter saturation voltage	$I_C = 5A$ $I_B = 1A$			2	V
h_{FE} * DC current gain	$I_C = 3A$ $V_{CE} = 4V$	15		60	—
	$I_C = 5A$ $V_{CE} = 4V$	8			—
f_T Transition frequency	$I_C = 1A$ $V_{CE} = 15V$ $f = 10MHz$	8			MHz
t_{on} Turn-on time	$I_C = 5A$ $I_{B1} = 1A$ $V_{CC} = 150V$			1	μs
t_s Storage time	$I_C = 5A$ $I_{B1} = -I_{B2} = 1A$ $V_{CC} = 150V$			2.2	μs
t_f Fall time				1.2	μs

* Pulsed: pulse duration = $300\mu s$, duty cycle $\leq 2\%$.

MULTIEPITAXIAL MESA NPN

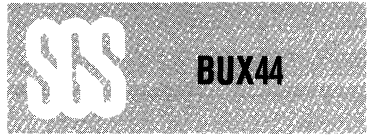

HIGH VOLTAGE POWER SWITCH

The BUX 44 is a silicon multiepitaxial mesa NPN transistor in Jedec TO-3 metal case, intended for high voltage, fast switching applications.

ABSOLUTE MAXIMUM RATINGS

V_{CES}	Collector-emitter voltage ($V_{BE} = 0$)	450	V
V_{CER}	Collector-emitter voltage ($R_{BE} \leq 100\Omega$)	440	V
V_{CEO}	Collector-emitter voltage ($I_B = 0$)	400	V
V_{EBO}	Emitter-base voltage ($I_C = 0$)	7	V
I_C	Collector current	8	A
I_{CM}	Collector peak current ($t_p \leq 10ms$)	10	A
I_B	Base current	1.6	A
P_{tot}	Total power dissipation at $T_{case} \leq 25^\circ C$	120	W
T_{stg}	Storage temperature	-65 to 200	$^\circ C$
T_j	Junction temperature	200	$^\circ C$

INTERNAL SCHEMATIC DIAGRAM

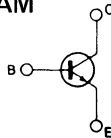

MECHANICAL DATA

Dimensions in mm

Collector connected to case

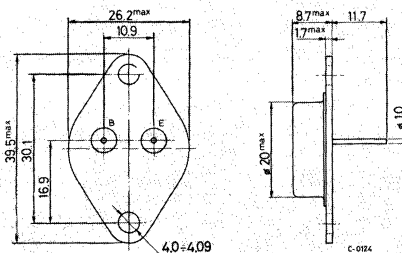

TO-3

**BUX44****THERMAL DATA**

$R_{th\ j-case}$	Thermal resistance junction-case	max 1.46 °C/W
------------------	----------------------------------	---------------

ELECTRICAL CHARACTERISTICS ($T_{case} = 25^{\circ}C$ unless otherwise specified)

Parameter		Test conditions		Min.	Typ.	Max.	Unit
I_{CES}	Collector cutoff current ($V_{BE} = 0$)	$V_{CE} = 450V$ $V_{CE} = 450V$	$T_{case} = 125^{\circ}C$			1 5	mA mA
I_{CEO}	Collector cutoff current ($I_B = 0$)	$V_{CE} = 320V$				1	mA
I_{EBO}	Emitter cutoff current ($I_C = 0$)	$V_{EB} = 7V$				1	mA
$V_{CEO(sus)}$	*Collector-emitter sustaining voltage ($I_B = 0$)	$I_C = 100mA$		400			V
$V_{CE(sat)}$	* Collector-emitter saturation voltage	$I_C = 2A$ $I_C = 4A$	$I_B = 0.25A$ $I_B = 0.8A$			1 2	V V
$V_{BE(sat)}$	* Base-emitter saturation voltage	$I_C = 4A$	$I_B = 0.8A$			2	V
h_{FE}	* DC current gain	$I_C = 2A$ $I_C = 4A$	$V_{CE} = 4V$ $V_{CE} = 4V$	15 8		45	— —
f_T	Transition frequency	$I_C = 1A$ $f = 10MHz$	$V_{CE} = 15V$	8			MHz
t_{on}	Turn-on time	$I_C = 4A$ $V_{CC} = 150V$	$I_B = 0.8A$			1	μs
t_s	Storage time	$I_C = 4A$ $V_{CC} = 150V$	$I_{B1} = -I_{B2} = 0.8A$			2.5	μs
t_f	Fall time					1.2	μs

* Pulsed: pulse duration = $300\mu s$, duty cycle $\leq 2\%$.



MULTIEPITAXIAL MESA NPN

HIGH VOLTAGE POWER SWITCH

The BUX 46 is a silicon multiepitaxial mesa NPN transistor in Jedec TO-3 metal case, intended for high voltage, fast switching applications.

ABSOLUTE MAXIMUM RATINGS

V_{CES}	Collector-emitter voltage ($V_{BE} = 0$)	850	V
V_{CER}	Collector-emitter voltage ($R_{BE} \leq 10\Omega$)	850	V
V_{CEO}	collector-emitter voltage ($I_B = 0$)	400	V
V_{EBO}	Emitter-base voltage ($I_C = 0$)	7	V
I_C	Collector current	5	A
I_B	Base current	3	A
P_{tot}	Total power dissipation at $T_{case} \leq 25^\circ C$	85	W
T_{stg}	Storage temperature	-65 to 175	$^\circ C$
T_j	Junction temperature	175	$^\circ C$

INTERNAL SCHEMATIC DIAGRAM

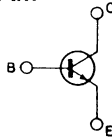

MECHANICAL DATA

Dimensions in mm

Collector connected to case

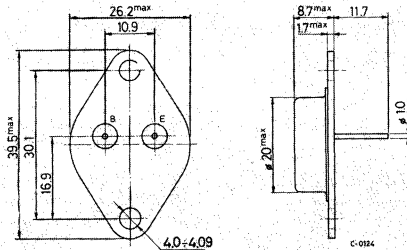

TO-3

**BUX46****THERMAL DATA**

$R_{th\ j-case}$	Thermal resistance junction-case	max	1.75	$^{\circ}C/W$
------------------	----------------------------------	-----	------	---------------

ELECTRICAL CHARACTERISTICS ($T_{case} = 25^{\circ}C$ unless otherwise specified)

Parameter	Test conditions	Min.	Typ.	Max.	Unit
I_{CES} Collector cutoff current ($V_{BE} = 0$)	$V_{CE} = 850V$ $V_{CE} = 850V$ $T_{case} = 125^{\circ}C$			100 1	μA mA
I_{CER} Collector cutoff current ($R_{BE} \leq 10\Omega$)	$V_{CE} = 850V$ $V_{CE} = 850V$ $T_{case} = 125^{\circ}C$			300 2	μA mA
I_{EBO} Emitter cutoff current ($I_C = 0$)	$V_{EB} = 7V$			1	mA
$V_{CEO(sus)}$ * Collector-emitter sustaining voltage ($I_B = 0$)	$I_C = 100mA$	400			V
$V_{CE(sat)}$ * Collector-emitter saturation voltage	$I_C = 2.5A$ $I_B = 0.5A$ $I_C = 3.5A$ $I_B = 0.7A$			1.5 5	V V
$V_{BE(sat)}$ * Base-emitter saturation voltage	$I_C = 2.5A$ $I_B = 0.5A$			1.3	V
t_{on} Turn-on time	$I_C = 2.5A$ $V_{CC} = 150V$ $I_{B1} = -I_{B2} = 0.5A$			1	μs
t_s Storage time				3	μs
t_f Fall time				0.8	μs

* Pulsed: pulse duration = 300 μs , duty cycle $\leq 2\%$.



MULTIEPITAXIAL MESA NPN

HIGH VOLTAGE POWER SWITCH

The BUX 47 is a silicon multiepitaxial mesa NPN transistor in Jedec TO-3 metal case, intended for high voltage, fast switching applications.

ABSOLUTE MAXIMUM RATINGS

V_{CES}	Collector-emitter voltage ($V_{BE} = 0$)	850	V
V_{CER}	Collector-emitter voltage ($R_{BE} \leq 10\Omega$)	850	V
V_{CEO}	Collector-emitter voltage ($I_B = 0$)	400	V
V_{EBO}	Emitter-base voltage ($I_C = 0$)	7	V
I_C	Collector current	8.5	A
I_{CM}	Collector peak current ($t_p \leq 10\text{ms}$)	12	A
I_B	Base current	3	A
I_{BM}	Base peak current ($t_p \leq 10\text{ms}$)	6	A
P_{tot}	Total power dissipation at $T_{case} \leq 25^\circ\text{C}$	107	W
T_{stg}	Storage temperature	-65 to 175	$^\circ\text{C}$
T_j	Junction temperature	175	$^\circ\text{C}$

INTERNAL SCHEMATIC DIAGRAM

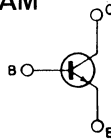

MECHANICAL DATA

Dimensions in mm

Collector connected to case

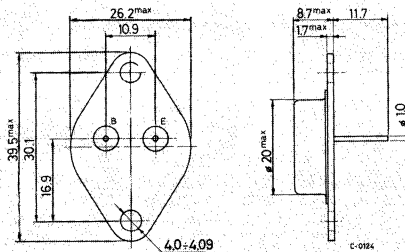

TO-3

**BUX47****THERMAL DATA**

$R_{th\ j-case}$	Thermal resistance junction-case	max	1.4	°C/W
------------------	----------------------------------	-----	-----	------

ELECTRICAL CHARACTERISTICS ($T_{case} = 25^{\circ}C$ unless otherwise specified)

Parameter	Test conditions	Min.	Typ.	Max.	Unit
I_{CES}	Collector cutoff current ($V_{BE} = 0$)	$V_{CE} = 850V$ $V_{CE} = 850V$	$T_{case} = 125^{\circ}C$	150 1.5	μA mA
I_{CER}	Collector cutoff current ($R_{BE} \leq 10\Omega$)	$V_{CE} = 850V$ $V_{CE} = 850V$	$T_{case} = 125^{\circ}C$	400 3	μA mA
I_{EBO}	Emitter cutoff current ($I_C = 0$)	$V_{EB} = 7V$		1	mA
$V_{CEO(sus)}$	*Collector-emitter sustaining voltage ($I_B = 0$)	$I_C = 100mA$		400	V
$V_{CE(sat)}$	*Collector-emitter saturation voltage	$I_C = 6A$ $I_C = 9A$	$I_B = 1.2A$ $I_B = 3A$	1.5 3	V V
$V_{BE(sat)}$	*Base-emitter saturation voltage	$I_C = 6A$	$I_B = 1.2A$	1.6	V
t_{on}	Turn-on time			1	μs
t_s	Storage time	$I_C = 6A$ $I_{B1} = -I_{B2} = 1.2A$	$V_{CC} = 150V$	3	μs
t_f	Fall time			0.8	μs

* Pulsed: pulse duration = $300\mu s$, duty cycle $\leq 2\%$.

MULTIEPITAXIAL MESA NPN



VERY HIGH VOLTAGE POWER SWITCH

The BUX48 series are multiepitaxial mesa NPN transistors in a Jecdec TO-3 metal case, particularly intended for switching and industrial applications from single and three-phase mains operation.

ABSOLUTE MAXIMUM RATINGS

		BUX48	BUX48A	BUX48B	BUX48C
V_{CES}	Collector-emitter voltage ($V_{BE} = 0$)	850V	1000V	1000V	1000V
V_{CER}	Collector-emitter voltage ($R_{BE} = 10\Omega$)	850V	1000V	1000V	1000V
V_{CEO}	Collector-emitter voltage ($I_B = 0$)	400V	450V	600V	700V
V_{EBO}	Emitter-base voltage ($I_C = 0$)		7V		
I_C	Collector current		15A		
I_{CM}	Collector peak current ($t_p \leq 5ms$)		30A		
I_{CP}	Collector peak current non repetitive ($t_p \leq 20\mu s$)			55A	
I_B	Base current		4A		
I_{BM}	Base peak current ($t_p \leq 5ms$)		20A		
P_{tot}	Total power dissipation at $T_{case} \leq 25^\circ C$		175W		
T_{stg}	Storage temperature		-65 to 200°C		
T_j	Junction temperature		200°C		

INTERNAL SCHEMATIC DIAGRAM

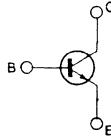

MECHANICAL DATA

Dimensions in mm

Collector connected to case

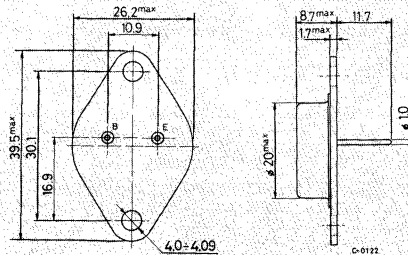

TO-3



THERMAL DATA

$R_{th\ j-case}$	Thermal resistance junction-case	max.	1	$^{\circ}C/W$
------------------	----------------------------------	------	---	---------------

ELECTRICAL CHARACTERISTICS ($T_{case} = 25^{\circ}C$ unless otherwise specified)

Parameter	Test conditions	Min.	Typ.	Max.	Unit
I_{CES} Collector cutoff current ($V_{BE} = 0$)	for BUX48 and BUX48A			200	μA
	$V_{CE} = V_{CES}$ $T_{case} = 125^{\circ}C$			2	mA
	for BUX48B and BUX48C			500	μA
	$V_{CE} = V_{CES}$ $T_{case} = 125^{\circ}C$			3	mA
I_{CER} Collector cutoff current ($R_{BE} = 10\Omega$)	$V_{CE} = V_{CES}$ $T_{case} = 125^{\circ}C$			500	μA
	$V_{CE} = V_{CES}$			4	mA
I_{CEO} Collector cutoff current ($I_B = 0$)	for BUX48B			1	mA
	for BUX48C			1	mA
I_{EBO} Emitter cutoff current ($I_C = 0$)	$V_{EB} = 5V$			1	mA
$V_{CEO(sus)}$ * Collector-emitter sustaining voltage	for BUX48	$I_C = 200mA$	400		V
	for BUX48A	$I_C = 200mA$	450		V
	for BUX48B	$I_C = 100mA$	600		V
	for BUX48C	$I_C = 100mA$	700		V
$V_{CER(sus)}$ * Collector-emitter sustaining voltage ($R_{BE} = 10\Omega$)	for BUX48B and BUX48C $L = 2mH$ $V_{Clamp} = 1000V$ $I_C = 0.5A$		1000		V



ELECTRICAL CHARACTERISTICS (continued)

Parameter	Test conditions	Min.	Typ.	Max.	Unit
$V_{CE(sat)}$ * Collector-emitter saturation voltage	for BUX48 $I_C = 10A$ $I_B = 2A$ $I_C = 15A$ $I_B = 3A$ for BUX48A $I_C = 8A$ $I_B = 1.6A$ $I_C = 12A$ $I_B = 2.4A$ for BUX48B and BUX48C $I_C = 6A$ $I_B = 1.5A$ $I_C = 8A$ $I_B = 2.5A$ $I_C = 10A$ $I_B = 4A$			1.5 5 1.5 5 1.5 2 3	V V V V V V V
$V_{BE(sat)}$ * Base-emitter saturation voltage	for BUX48 $I_C = 10A$ $I_B = 2A$ for BUX48A $I_C = 8A$ $I_B = 1.6A$ for BUX48B and BUX48C $I_C = 6A$ $I_B = 1.5A$ $I_C = 10A$ $I_B = 4A$			1.6 1.6 1.6 2	V V V V
t_{on} Turn-on time (resistive load)	for BUX48 $V_{CC} = 150V$ $I_C = 10A$ $I_{B1} = -I_{B2} = 2A$ for BUX48A $V_{CC} = 150V$ $I_C = 8A$ $I_{B1} = -I_{B2} = 1.6A$ for BUX48B and BUX48C $V_{CC} = 250V$ $I_C = 6A$ $I_{B1} = -I_{B2} = 1.5A$			1 1 0.500 1	μs μs μs
t_s Storage time (resistive load)	for BUX48 $V_{CC} = 150V$ $I_C = 10A$ $I_{B1} = -I_{B2} = 2A$ for BUX48A $V_{CC} = 150V$ $I_C = 8A$ $I_{B1} = -I_{B2} = 1.6A$ for BUX48B and BUX48C $V_{CC} = 250V$ $I_C = 6A$ $I_{B1} = -I_{B2} = 1.5A$			3 3 1.5 3	μs μs μs
t_f Fall time (resistive load)	for BUX48 $V_{CC} = 150V$ $I_C = 10A$ $I_{B1} = -I_{B2} = 2A$ for BUX48A $V_{CC} = 150V$ $I_C = 8A$ $I_{B1} = -I_{B2} = 1.6A$ for BUX48B and BUX48C $V_{CC} = 250V$ $I_C = 6A$ $I_{B1} = -I_{B2} = 1.5A$			0.8 0.8 0.200 0.8	μs μs μs

* Pulsed: pulse duration = 300 μs , duty cycle -1.5%.

Safe operating areas

G-4797/1

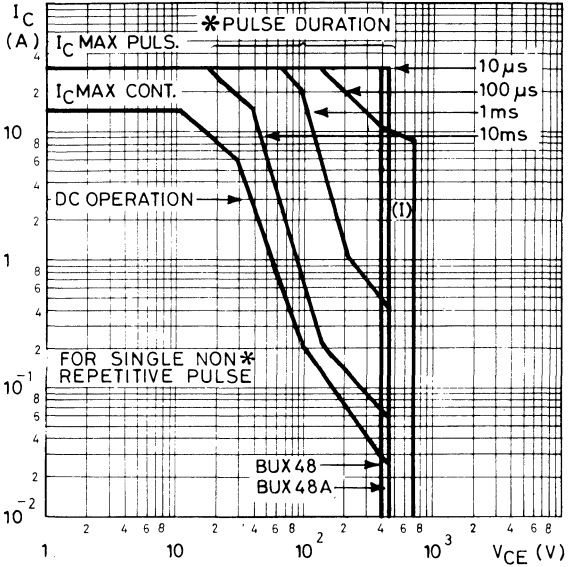

I - Area of permissible operation during turn-on provided $R_{BE} \leq 100\Omega$ and $t_p \leq 0.25 \mu s$

Safe operating areas

G-4798/1

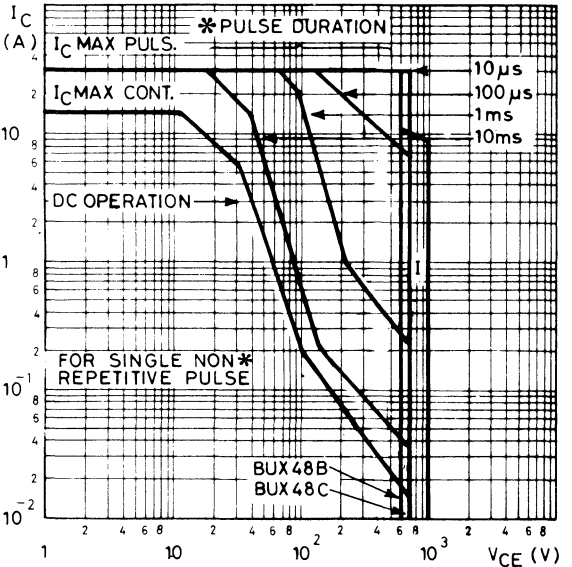

I - Area of permissible operation during turn-on provided $R_{BE} \leq 100\Omega$ and $t_p \leq 0.25 \mu s$



Clamped reverse bias safe operating areas

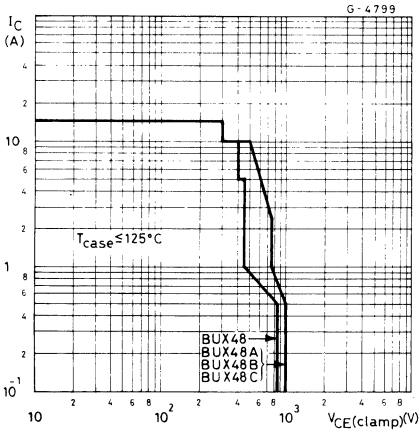

Collector-emitter saturation voltage

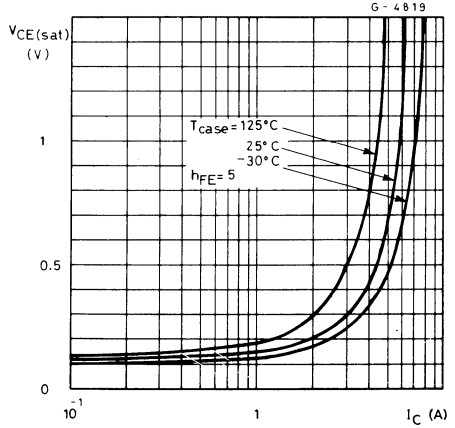

Collector-emitter saturation voltage

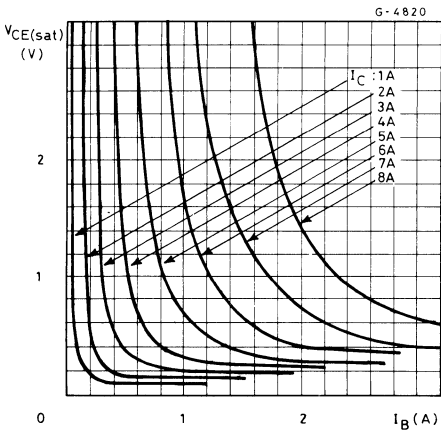

Base-emitter saturation voltage

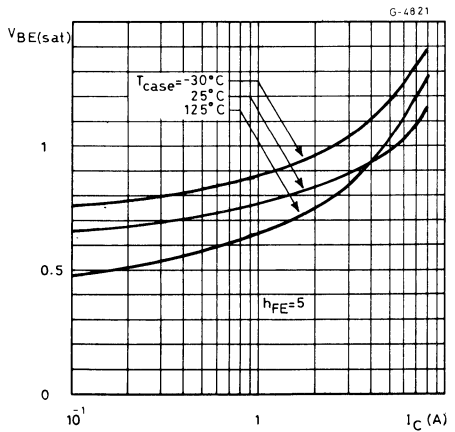

DC current gain

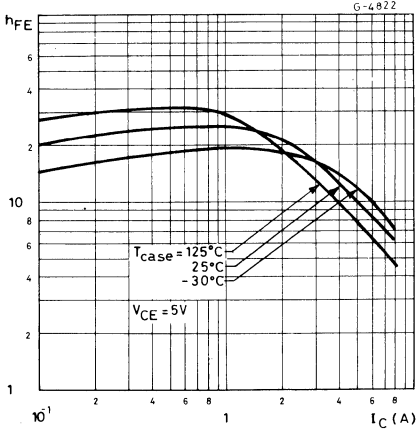

Saturated switching characteristics

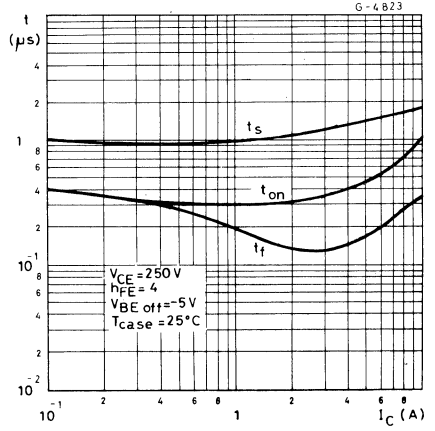

Saturated switching characteristics

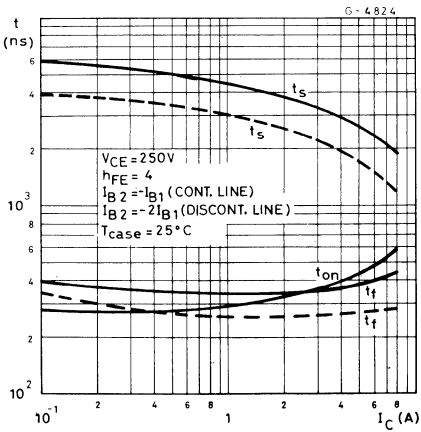

Saturated switching characteristics

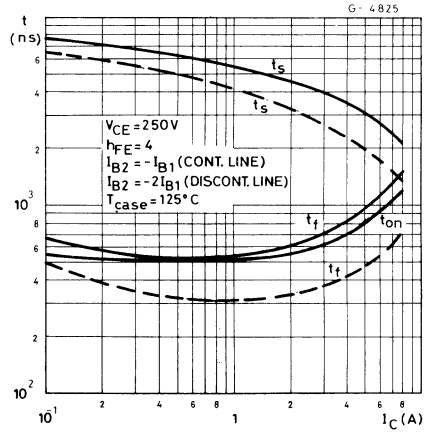



Maximum base current I_{BD} to drive the discrete Darlington in saturated limit conditions

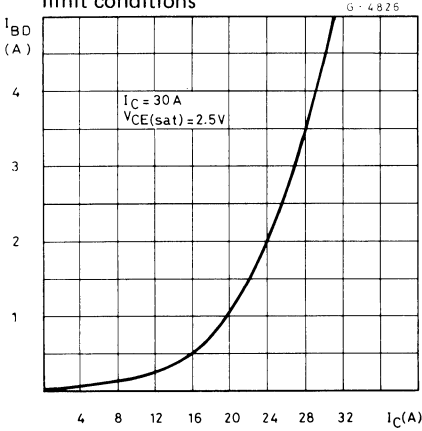

Derating curves

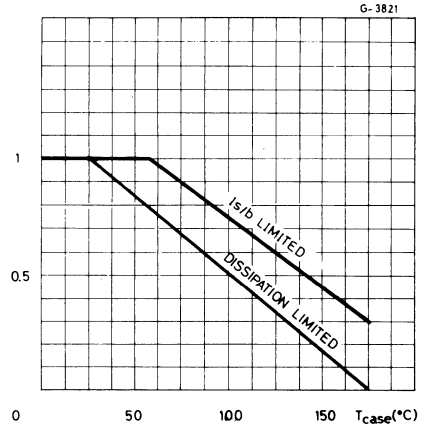

Thermal transient response

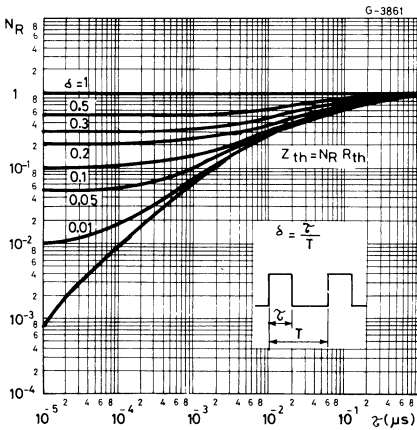

DC current gain (only for BUX48/A)

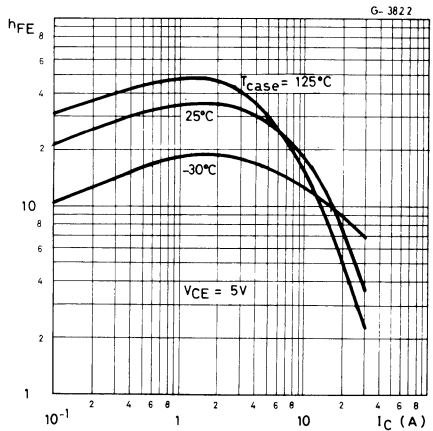



Collector-emitter saturation voltage (only for BUX48/A)

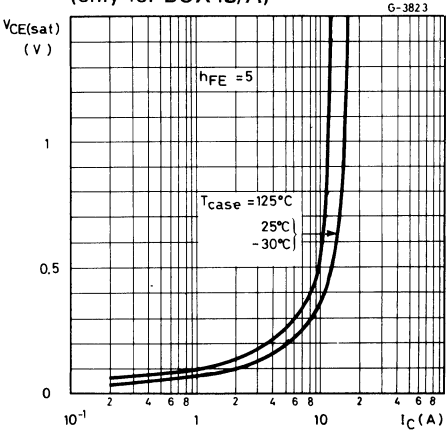

Collector-emitter saturation voltage (only for BUX48/A)

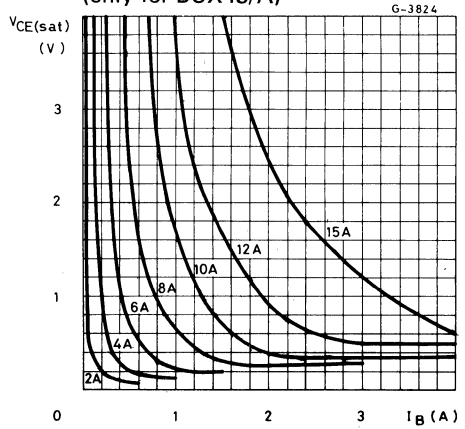

Base-emitter saturation voltage (only for BUX48/A)

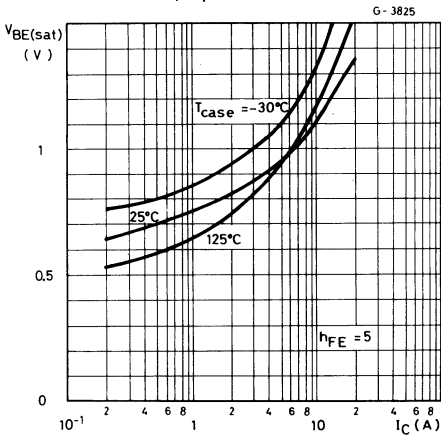

Extreme characteristics I_C vs. V_{BE} at V_{CE} constant (only for BUX48/A)

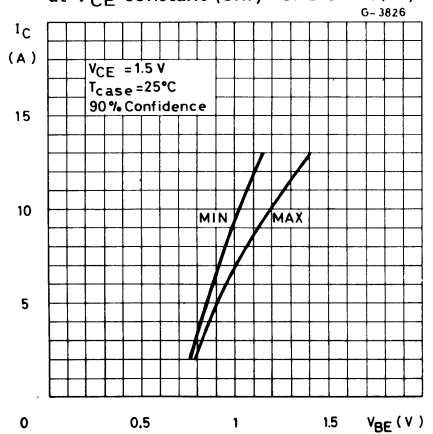



Saturated switching characteristics (only for BUX48/A)

G-3827

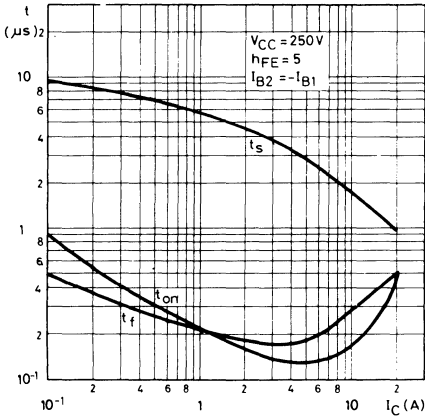

Saturated switching characteristics (only for BUX48/A)

G-3828

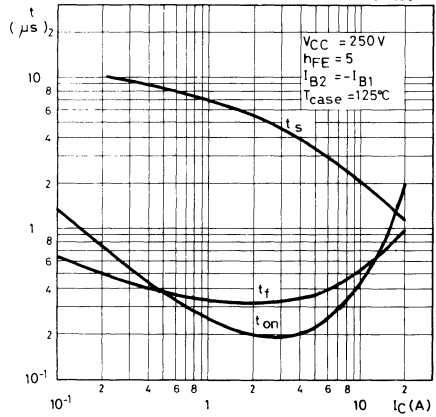

Transition frequency (only for BUX48/A)

G-3829

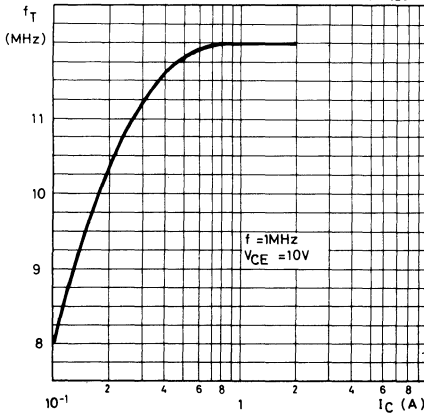

Clamped $E_{s/b}$ test circuit

TEST CONDITIONS:

$$5V > | -V_{BB} | \geq 2V$$

$$I_C / I_B = 5$$

$$2|I_{B1}| > | -I_{B2} | > I_{B1}$$

t_p = adjusted for nominal I_C

R_{BB} = adjusted for I_{B2}

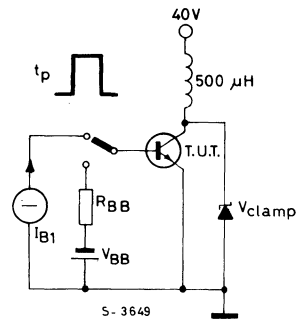

S-3649

Switching times test circuit inductive load

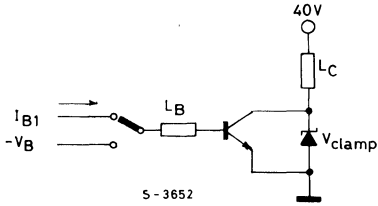

Discrete Darlington configuration using BUX48 series devices

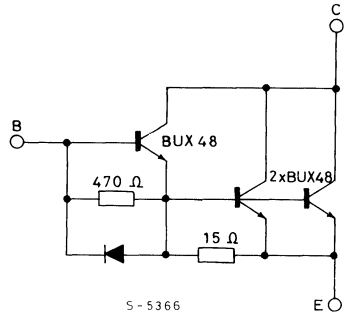

Switchable power at 30A: 18KVA

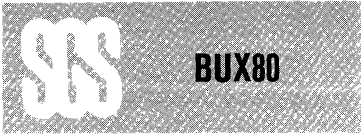

MULTIEPITAXIAL MESA NPN

HIGH VOLTAGE POWER SWITCH

The BUX 80 is a silicon multiepitaxial mesa NPN transistor in Jedec TO-3 metal case, particularly intended for converters, inverters, switching regulators and motor control systems applications.

ABSOLUTE MAXIMUM RATINGS

V_{CES}	Collector-emitter voltage ($V_{BE} = 0$)	800	V
V_{CER}	Collector-emitter voltage ($R_{BE} = 50\Omega$)	500	V
V_{CEO}	Collector-emitter voltage ($I_B = 0$)	400	V
V_{EBO}	Emitter-base voltage ($I_C = 0$)	10	V
I_C	Collector current	10	A
I_{CM}	Collector peak current	15	A
I_B	Base current	5	A
P_{tot}	Total power dissipation at $T_{case} \leq 40^\circ C$	100	W
T_{stg}	Storage temperature	-65 to 150	$^\circ C$
T_j	Junction temperature	150	$^\circ C$

INTERNAL SCHEMATIC DIAGRAM

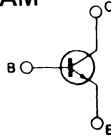

MECHANICAL DATA

Dimensions in mm

Collector connected to case

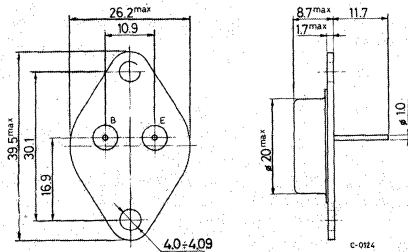

TO-3

**BUX80****THERMAL DATA**

$R_{th\ j-case}$	Thermal resistance junction-case	max	1.1	°C/W
------------------	----------------------------------	-----	-----	------

ELECTRICAL CHARACTERISTICS ($T_{case} = 25^{\circ}C$ unless otherwise specified)

Parameter	Test conditions	Min.	Typ.	Max.	Unit
I_{CES} Collector cutoff current ($V_{BE}=0$)	$V_{CE}=800V$ $V_{CE}=800V$ $T_{case}=125^{\circ}C$			1 3	mA mA
I_{EBO} Emitter cutoff current ($I_C=0$)	$V_{EB}=10V$			10	mA
$V_{CEO(sus)}$ *Collector-emitter sustaining voltage ($I_B=0$)	$I_C = 100mA$	400			V
$V_{CER(sus)}$ * Collector-emitter sustaining voltage ($R_{BE}=50\Omega$)	$I_C = 100mA$	500			V
$V_{CE(sat)}$ * Collector-emitter saturation voltage	$I_C = 5A$ $I_B = 1A$ $I_C = 8A$ $I_B = 2.5A$			1.5 3	V V
$V_{BE(sat)}$ * Base-emitter saturation voltage	$I_C = 5A$ $I_B = 1A$ $I_C = 8A$ $I_B = 2.5A$			1.4 1.8	V V
h_{FE} * DC current gain	$I_C = 1.2A$ $V_{CE}=5V$		30		—
t_{on} Turn-on time	$I_C = 5A$ $I_{B1} = 1A$ $V_{CC}=250V$			0.5	μs
t_s Storage time	$I_C = 5A$ $I_{B1} = 1A$ $I_{B2} = -2A$ $V_{CC}=250V$			3.5	μs
t_f Fall time	$I_C = 5A$ $I_{B1} = 1A$ $I_{B2} = -2A$ $V_{CC}=-250V$			0.5	μs

* Pulsed; pulse duration = 300 μs , duty cycle = 1.5%

Safe operating areas

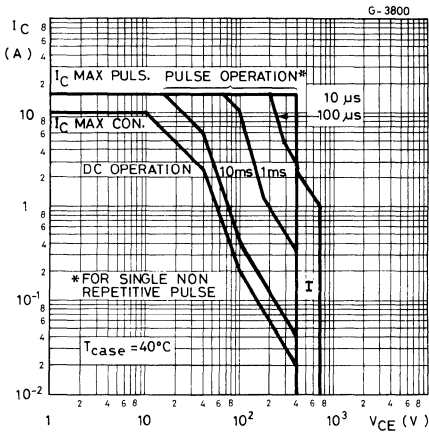

Derating curves

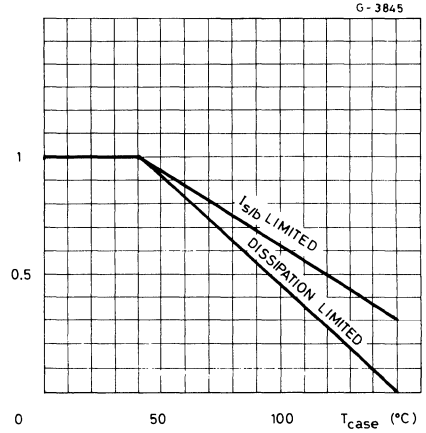

I — Area of permissible operation during Turn-on provided $R_{BE} \leq 100\Omega$ and $t_p \leq 0,6\mu s$

Transient thermal response

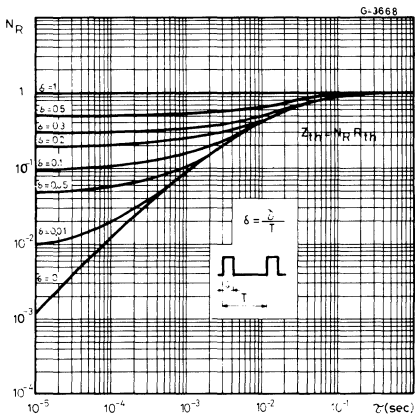

DC current gain

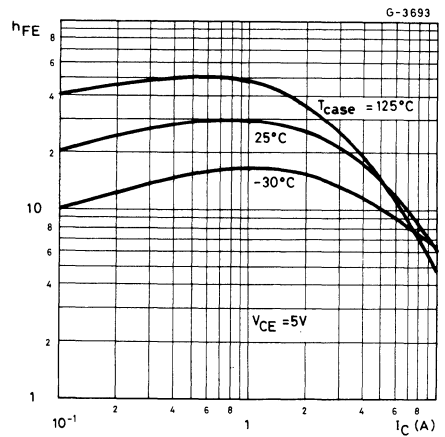

Collector-emitter saturation voltage

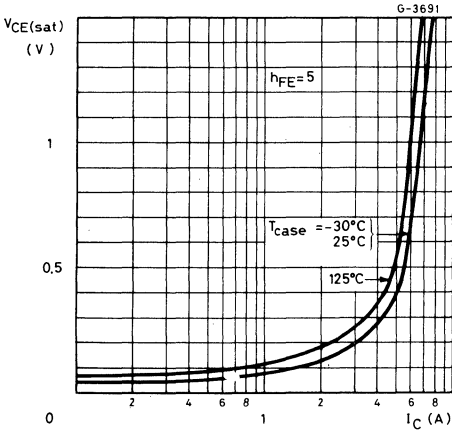

Collector-emitter saturation voltage

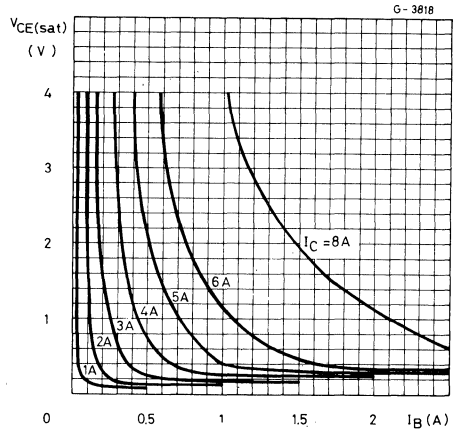

Base-emitter saturation voltage

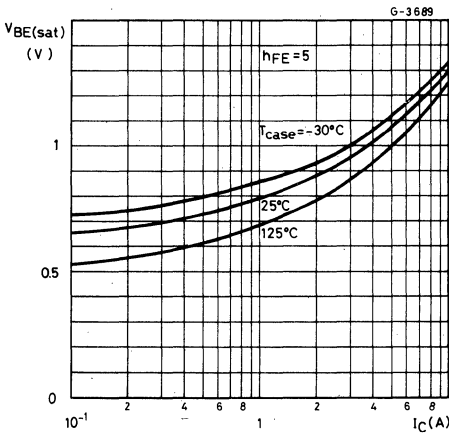

Saturated switching characteristics

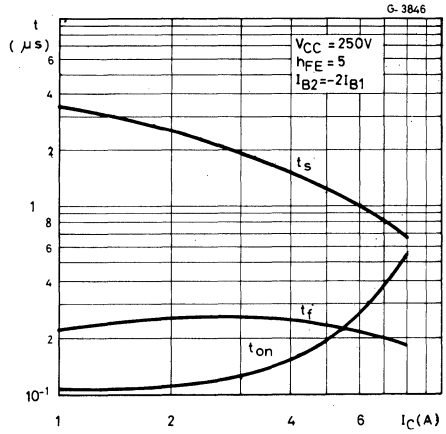

Saturated switching characteristics

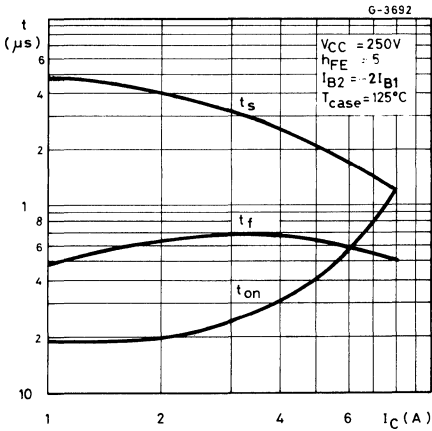

Saturated switching characteristics

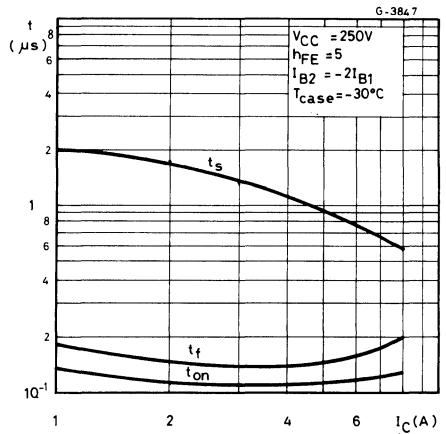

Clamped reverse bias safe operating areas

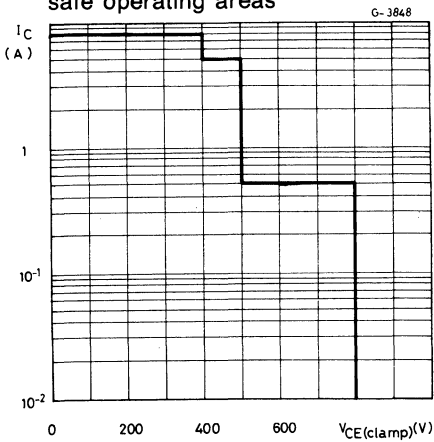

Clamped $E_{s/b}$ test circuit

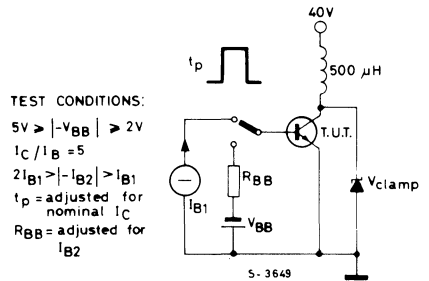



BUX84

MULTIEPITAXIAL MESA NPN

HIGH VOLTAGE SWITCH

The BUX84, is a multi-epitaxial mesa NPN transistor, intended for use in converters inverters, switching regulators, motor control systems and switching applications. It is mounted in Jedec TO-220 plastic package.

ABSOLUTE MAXIMUM RATINGS

V_{CES}	Collector-emitter voltage ($V_{BE} = 0$)	800	V
V_{CEO}	Collector-emitter voltage ($I_B = 0$)	400	V
I_C	Collector current	2	A
I_{CM}	Collector peak current	3	A
I_B	Base current	0.75	A
I_{BM}	Base peak current	1	A
P_{tot}	Total power dissipation at $T_{case} \leq 25^\circ C$	40	W
T_{stg}	Storage temperature	-65 to 150	$^\circ C$
T_j	Junction temperature	150	$^\circ C$

INTERNAL SCHEMATIC DIAGRAM

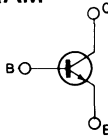

MECHANICAL DATA

Dimensions in mm

Collector connected to tab.

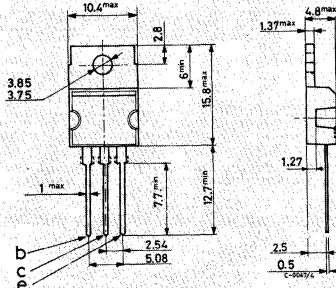

TO-220

**BUX84****THERMAL DATA**

$R_{th\ j-case}$ Thermal resistance junction-case	max. 2.5 °C/W
---	---------------

ELECTRICAL CHARACTERISTICS ($T_{case} = 25^{\circ}C$ unless otherwise specified)

Parameter	Test conditions	Min.	Typ.	Max.	Unit
I_{CES} Collector cutoff current ($V_{BE} = 0$)	$V_{CE} = V_{CES}$ $V_{CE} = V_{CES}$ $T_j = 125^{\circ}C$			200 1.5	μA mA
I_{EBO} Emitter cutoff current ($I_C = 0$)	$V_{EB} = 5V$			1	mA
$V_{CEO(sus)}$ * Collector-emitter sustaining voltage	$I_C = 100mA$ $I_B = 0$ $L = 25mH$	400			V
$V_{CE(sat)}$ * Collector-emitter saturation voltage	$I_C = 0.3A$ $I_B = 30mA$ $I_C = 1A$ $I_B = 0.2A$			1.5 3	V V
$V_{BE(sat)}$ * Base-emitter saturation voltage	$I_C = 1A$ $I_B = 0.2A$			1.1	V
h_{FE} * DC current gain	$V_{CE} = 5V$ $I_C = 0.1A$		50		—
t_{on} Turn-on time	$I_C = 1A$ $V_{CC} = 250V$ $I_B = 0.2A$ $-I_B = 0.4A$		300	500	ns
t_s Storage time			1	3.5	μs
t_f Fall time			0.1	1.4	μs

* Pulsed: pulse duration = 300 μs , duty cycle = 1%.



BUY18S

EPITAXIAL PLANAR NPN

FAST SWITCHING HIGH VOLTAGE POWER

The BUY 18S is a silicon planar epitaxial NPN transistor in Jedec TO-3 metal case. It is intended for high-voltage switching power applications.

ABSOLUTE MAXIMUM RATINGS

V_{CBO}	Collector-base voltage ($I_E = 0$)	400	V
V_{CEO}	Collector-emitter voltage ($I_B = 0$)	200	V
V_{EBO}	Emitter-base voltage ($I_C = 0$)	6	V
I_C	Collector current	7	A
I_{CM}	Collector peak current (repetitive)	10	A
I_{CM}	Collector peak current ($t \leq 10$ ms)	15	A
I_B	Base current	4	A
P_{tot}	Total power dissipation at $T_{case} \leq 75$ °C	50	W
T_{stg}	Storage temperature	-65 to 175	°C
T_j	Junction temperature	175	°C

INTERNAL SCHEMATIC DIAGRAM

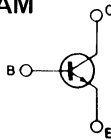

MECHANICAL DATA

Dimensions in mm

Collector connected to case

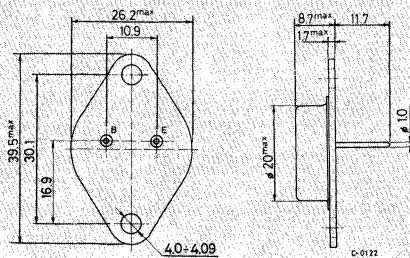

TO-3

**BUY18S****THERMAL DATA**

$R_{th\ j-case}$	Thermal resistance junction-case	max	2 °C/W
------------------	----------------------------------	-----	--------

ELECTRICAL CHARACTERISTICS ($T_{case} = 25\text{ °C}$ unless otherwise specified)

Parameter	Test conditions	Min.	Typ.	Max.	Unit
I_{CBO}	Collector cutoff current ($I_E = 0$)	$V_{CB} = 200V$ $V_{CB} = 200V$		$T_{case} = 100\text{ °C}$	10 2 μA mA
$V_{(BR)\ CBO}^*$	Collector-base breakdown voltage ($I_E = 0$)	$I_C = 5\text{ mA}$			400 V
V_{EBO}^*	Emitter-base voltage ($I_C = 0$)	$I_E = 1\text{ mA}$			6 V
$V_{CEO(SUS)}^*$	Collector-emitter sustaining voltage ($I_B = 0$)	$I_C = 20\text{ mA}$			200 V
$V_{CE(sat)}^*$	Collector-emitter saturation voltage	$I_C = 5A$ $I_C = 7A$	$I_B = 0.5A$ $I_B = 0.7A$	1 1	V V
$V_{BE(sat)}^*$	Base-emitter saturation voltage	$I_C = 5A$ $I_C = 7A$	$I_B = 0.5A$ $I_B = 0.7A$	1.4 1.6	V V
h_{FE}^*	DC current gain	$I_C = 1A$	$V_{CE} = 5V$	20 35	—
f_T	Transition frequency	$I_C = 0.5\text{ A}$	$V_{CE} = 10V$	30	MHz
C_{CBO}	Collector-base capacitance	$I_E = 0$ $f = 1\text{ MHz}$	$V_{CB} = 50V$	55	pF
t_{on}	Turn-on time	$I_C = 5A$	$I_{B1} = 0.5A$	1	μs
t_{off}	Turn-off time	$I_C = 5A$ $I_{B1} = -I_{B2} = 0.5A$		0.3 1	μs
$I_{s/b}^{**}$	Second breakdown collector current	$V_{CE} = 40V$		1	A

* Pulsed: pulse duration = 300 μs , duty cycle = 1.5 %

** Pulsed: 1s, non repetitive pulse

Safe operating areas

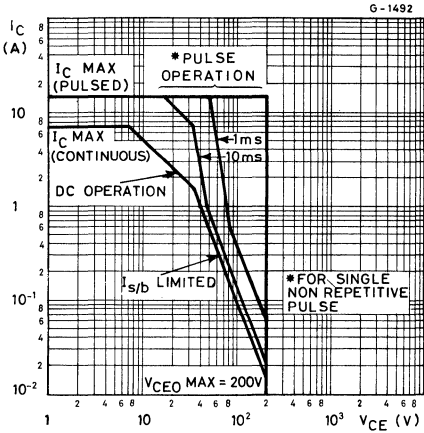

DC current gain

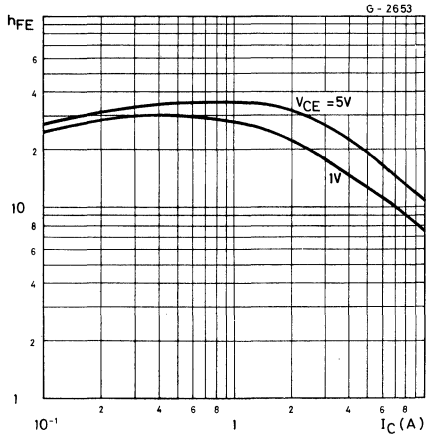

Collector-emitter saturation voltage

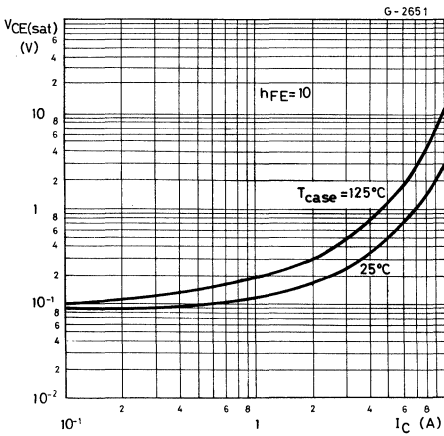

Base-emitter saturation voltage

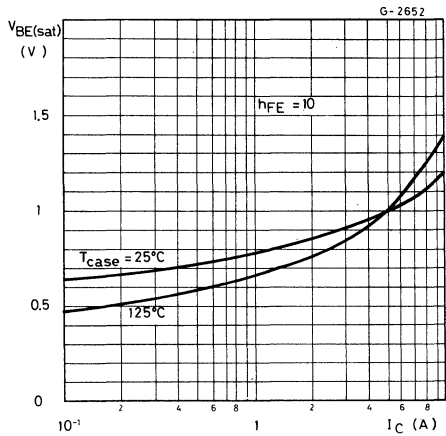



EPITAXIAL PLANAR NPN

HIGH VOLTAGE, HIGH CURRENT SWITCH

The BUY 47 and BUY 48 are silicon epitaxial planar NPN transistors in Jedec TO-39 metal case. They are used in high-voltage, high-current switching applications up to 7 A.

ABSOLUTE MAXIMUM RATINGS

		BUY 47	BUY 48
V_{CBO}	Collector-base voltage ($I_E = 0$)	150V	200V
V_{CEO}	Collector-emitter voltage ($I_B = 0$)	120V	170V
V_{EBO}	Emitter-base voltage ($I_C = 0$)		6V
I_C	Collector current		7A
I_{CM}	Collector peak current (repetitive)		10A
P_{tot}	Total power dissipation at $T_{amb} \leq 25^\circ C$ $T_{case} \leq 50^\circ C$		1W
T_{stg}	Storage temperature		10W
T_j	Junction temperature		-65 to 200 °C 200 °C

INTERNAL SCHEMATIC DIAGRAM

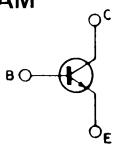

MECHANICAL DATA

Dimensions in mm

Collector connected to case

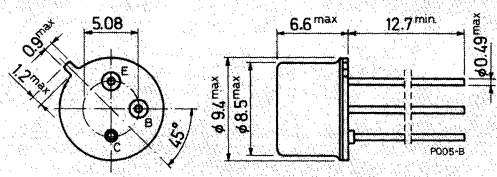

TO-39



BUY47
BUY48

THERMAL DATA

$R_{th\ j-case}$	Thermal resistance junction-case	max	15	°C/W
$R_{th\ j-amb}$	Thermal resistance junction-ambient	max	175	°C/W

ELECTRICAL CHARACTERISTICS ($T_{case} = 25^{\circ}C$ unless otherwise specified)

Parameter	Test conditions	Min.	Typ.	Max.	Unit
I_{CBO}	Collector cutoff current ($I_E = 0$) for BUY 47 $V_{CB} = 80\ V$ $V_{CB} = 80\ V$ $T_{case} = 125^{\circ}C$ for BUY 48 $V_{CB} = 100\ V$ $V_{CB} = 100\ V$ $T_{case} = 125^{\circ}C$			10 1 10 1	μA mA μA mA
$V_{(BR)\ CBO}^*$	Collector-base breakdown voltage ($I_E = 0$) $I_C = 1\ mA$ for BUY 47 for BUY 48	150		200	V V
$V_{CEO(sus)}^*$	Collector-emitter sustaining voltage ($I_B = 0$) $I_C = 20\ mA$ for BUY 47 for BUY 48	120		170	V V
V_{EBO}^*	Emitter-base voltage ($I_C = 0$) $I_E = 1\ mA$	6			V
$V_{CE(sat)}^*$	Collector-emitter saturation voltage $I_C = 0.5\ A$ $I_B = 50\ mA$ $I_C = 2\ A$ $I_B = 0.2\ A$ $I_C = 5\ A$ $I_B = 0.5\ A$	0.05		0.45 1	V V V
$V_{BE(sat)}^*$	Base-emitter saturation voltage $I_C = 0.5\ A$ $I_B = 50\ mA$ $I_C = 2\ A$ $I_B = 0.2\ A$ $I_C = 5\ A$ $I_B = 0.5\ A$	0.8		1.1 1.5	V V V



ELECTRICAL CHARACTERISTICS (continued)

Parameter	Test conditions	Min. Typ. Max.	Unit
h_{FE}^* DC current gain	$I_C = 50 \text{ mA}$ $V_{CE} = 5 \text{ V}$	130	—
	$I_C = 0.5 \text{ A}$ $V_{CE} = 5 \text{ V}$	40 150	—
	$I_C = 2 \text{ A}$ $V_{CE} = 5 \text{ V}$	40 130	—
	$I_C = 5 \text{ A}$ $V_{CE} = 5 \text{ V}$	15 45	—
f_T Transition frequency	$I_C = 100 \text{ mA}$ $V_{CE} = 10 \text{ V}$	90	MHz
C_{CBO} Collector-base capacitance	$I_E = 0$ $V_{CB} = 50 \text{ V}$ $f = 1 \text{ MHz}$	45 80	pF
t_{on} Turn-on time	$I_C = 5 \text{ A}$ $V_{CC} = 40 \text{ V}$ $I_{B1} = -I_{B2} = 0.5 \text{ A}$	1	μs
t_{off} Turn-off time		2	μs

* Pulsed: pulse duration = 300 μs , duty cycle = 1.5%

Safe operating areas

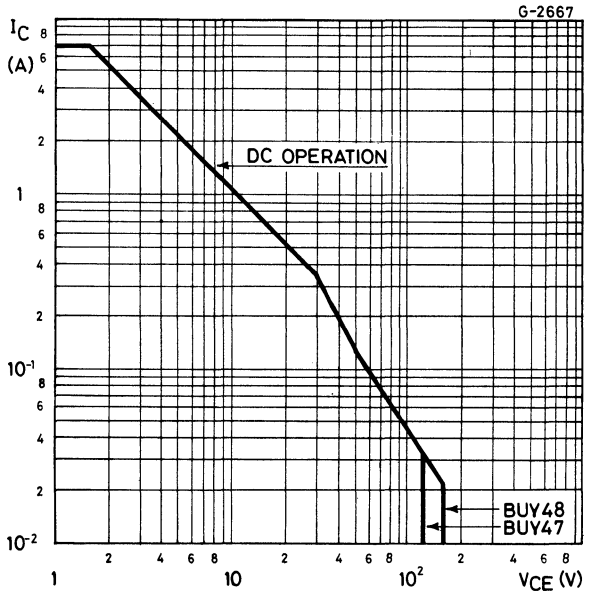



BUY47
BUY48

DC current gain

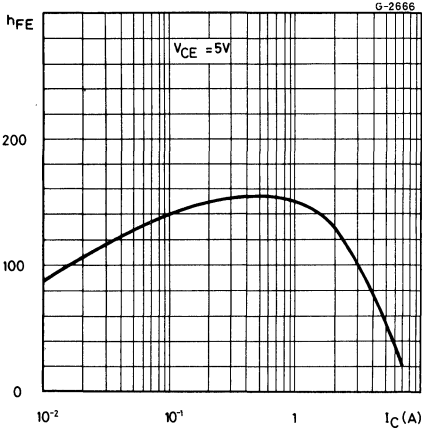

Collector-emitter saturation voltage

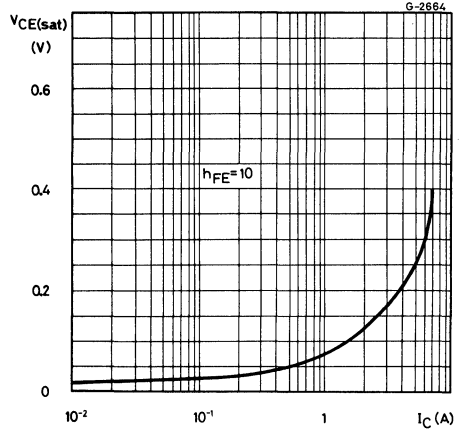

Base-emitter saturation voltage

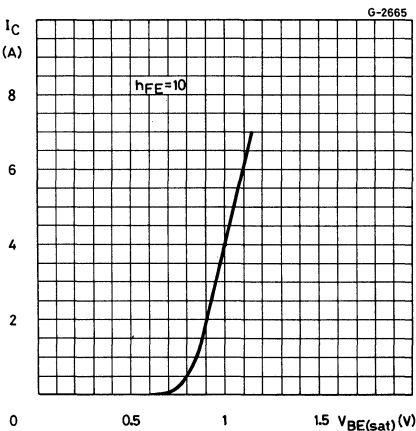

Collector-base capacitance

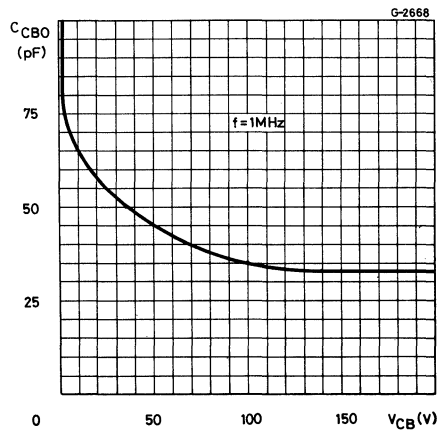

Saturated switching characteristics

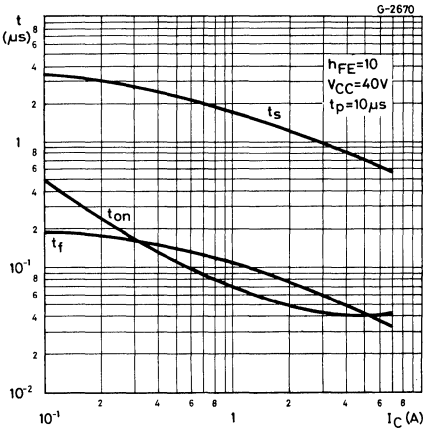

Power rating chart

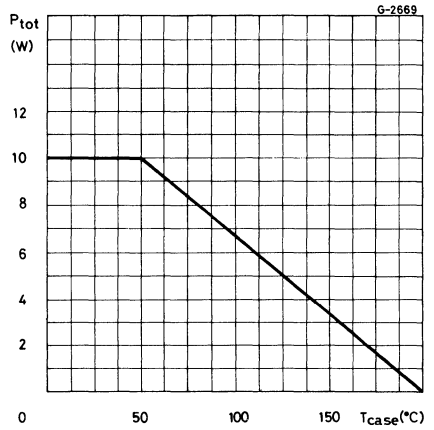

Switching time test circuit

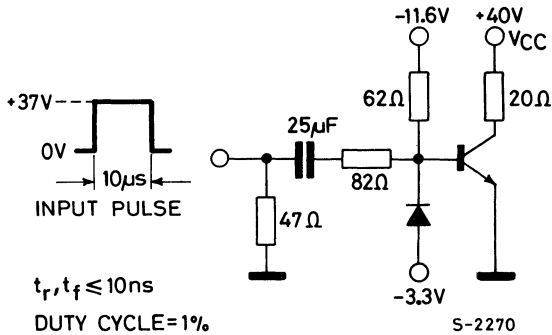



BUY49P

EPITAXIAL PLANAR NPN

HIGH VOLTAGE, MEDIUM CURRENT SWITCH

The BUY49P is a silicon epitaxial planar NPN transistor in Jedec TO-126 plastic package. It is used in high-current switching applications up to 3A.

ABSOLUTE MAXIMUM RATINGS

V_{CBO}	Collector-base voltage ($I_E = 0$)	250	V
V_{CEO}	Collector-emitter voltage ($I_B = 0$)	200	V
V_{EBO}	Emitter-base voltage ($I_C = 0$)	6	V
I_C	Collector current	3	A
I_{CM}	Collector peak current	5	A
P_{tot}	Total power dissipation at $T_{amb} \leq 25^\circ\text{C}$	15	W
T_{stg}	Storage temperature	-65 to 150	$^\circ\text{C}$
T_j	Junction temperature	150	$^\circ\text{C}$

INTERNAL SCHEMATIC DIAGRAM

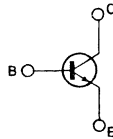

MECHANICAL DATA

Dimensions in mm

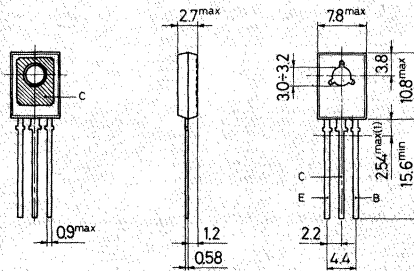

(1) Within this region the cross-section of the leads is uncontrolled

TO-126 (SOT-32)



THERMAL DATA

$R_{th\ j-case}$	Thermal resistance junction-case	max. 8.33 °C/W
------------------	----------------------------------	----------------

ELECTRICAL CHARACTERISTICS ($T_{case} = 25^{\circ}C$ unless otherwise specified)

Parameter	Test conditions	Min.	Typ.	Max.	Unit	
I_{CBO}	Collector cutoff current ($I_E = 0$)	$V_{CB} = 200V$			0.1	μA
V_{CBO}^*	Collector-base breakdown voltage ($I_E = 0$)	$I_C = 100\ \mu A$			250	V
$V_{CEO(sus)}^*$	Collector-emitter sustaining voltage ($I_B = 0$)	$I_C = 20mA$			200	V
V_{EBO}^*	Emitter-base voltage ($I_C = 0$)	$I_E = 1mA$			6	V
$V_{CE(sat)}^*$	Collector-emitter saturation voltage	$I_C = 0.5A$	$I_B = 50mA$		0.2	V
$V_{BE(sat)}^*$	Base-emitter saturation voltage	$I_C = 0.5A$	$I_B = 50mA$		1.1	V
h_{FE}^*	DC current gain	$I_C = 20mA$ $I_C = 20mA$ $I_C = 0.5A$ $I_C = 20mA$ $T_{case} = -55^{\circ}C$	$V_{CE} = 2V$ $V_{CE} = 5V$ $V_{CE} = 5V$ $V_{CE} = 2V$	30 40 40 16	120	— — — —
f_T	Transition frequency	$I_C = 100mA$	$V_{CE} = 10V$		30	MHz
C_{CBO}	Collector-base capacitance	$I_E = 0$ $f = 1MHz$	$V_{CB} = 10V$		50	pF
t_{on}	Turn-on time	$I_C = 0.5A$	$V_{CC} = 20V$		0.8	μs
t_{off}	Turn-off time	$I_{B1} = -I_{B2} = 50mA$		2.5	μs	

* Pulsed: pulse duration = 300 μs , duty cycle = 1.5%.



BUY49S

EPITAXIAL PLANAR NPN

HIGH VOLTAGE, MEDIUM CURRENT SWITCH

The BUY 49S is a silicon epitaxial planar NPN transistor in Jedec TO-39 metal case. It is used in high-voltage, high-current switching applications up to 3A.

ABSOLUTE MAXIMUM RATINGS

V_{CBO}	Collector-base voltage ($I_E = 0$)	250	V
V_{CEO}	Collector-emitter voltage ($I_B = 0$)	200	V
V_{EBO}	Emitter-base voltage ($I_C = 0$)	6	V
I_C	Collector current	3	A
I_{CM}	Collector peak current	5	A
P_{tot}	Total power dissipation at $T_{amb} \leq 25^\circ C$ $T_{case} \leq 50^\circ C$	1	W
T_{stg}	Storage temperature	-65 to 200	$^\circ C$
T_j	Junction temperature	200	$^\circ C$

INTERNAL SCHEMATIC DIAGRAM

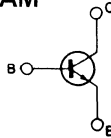

MECHANICAL DATA

Dimensions in mm

Collector connected to case

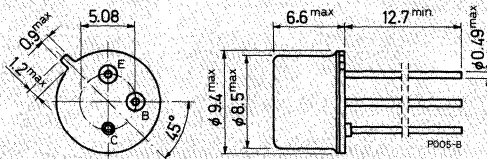

TO-39

THERMAL DATA

$R_{th\ j-case}$	Thermal resistance junction-case	max	15	°C/W
$R_{th\ j-amb}$	Thermal resistance junction-ambient	max	175	°C/W

ELECTRICAL CHARACTERISTICS ($T_{case} = 25^{\circ}C$ unless otherwise specified)

Parameter	Test conditions	Min. Typ. Max.	Unit
I_{CBO}	Collector cutoff current ($I_E = 0$) $V_{CB} = 200\ V$ $V_{CB} = 200\ V$ $T_{case} = 150^{\circ}C$	0.1 50	μA μA
$V_{(BR)\ CBO}^*$	Collector-base breakdown voltage ($I_E = 0$) $I_C = 100\ \mu A$	250	V
$V_{CEO\ (sus)}^*$	Collector-emitter sustaining voltage ($I_B = 0$) $I_C = 20\ mA$	200	V
V_{EBO}^*	Emitter-base voltage ($I_C = 0$) $I_E = 1\ mA$	6	V
$V_{CE\ (sat)}^*$	Collector-emitter saturation voltage $I_C = 0.5\ A$ $I_B = 50\ mA$	0.2	V
$V_{BE\ (sat)}^*$	Base-emitter saturation voltage $I_C = 0.5\ A$ $I_B = 50\ mA$	1.1	V
h_{FE}^*	DC current gain $I_C = 20\ mA$ $V_{CE} = 5\ V$ $I_C = 0.5\ A$ $V_{CE} = 5\ V$ $I_C = 20\ mA$ $V_{CE} = 2\ V$ $T_{case} = -55^{\circ}C$	40 40 80 16	— — —
f_T	Transition frequency $I_C = 100\ mA$ $V_{CE} = 10\ V$	50	MHz
C_{CBO}	Collector-base capacitance $I_E = 0$ $V_{CB} = 10\ V$ $f = 1\ MHz$	30	pF
t_{on}	Turn-on time $I_C = 0.5\ A$ $V_{CC} = 20\ V$	0.3	μs
t_{off}	Turn-off time $I_{B1} = -I_{B2} = 50\ mA$	1	μs
$I_{s/b}^{**}$	Second breakdown collector current $V_{CE} = 50\ V$	0.2	A

* Pulsed: pulse duration = 300 μs , duty cycle = 1.5%

** Pulsed: 1s, non repetitive pulse



BUY49S

Safe operating areas

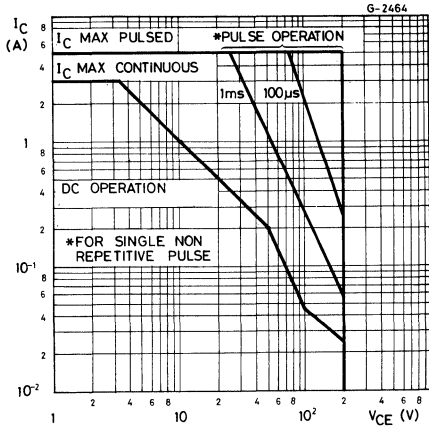

DC current gain

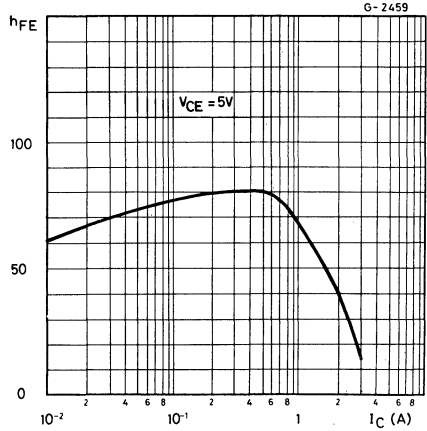

DC transconductance

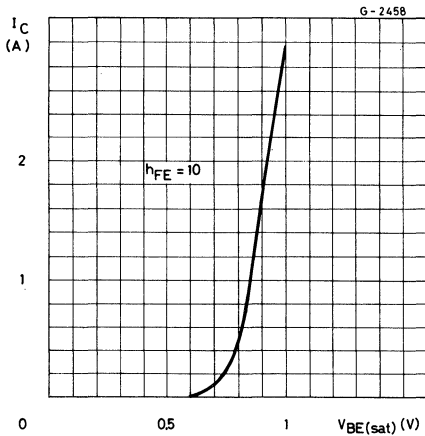

Collector-emitter saturation voltage

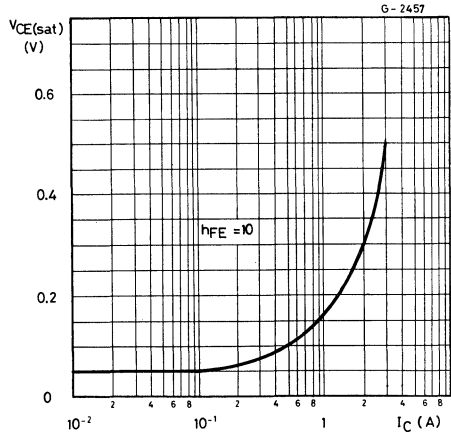

Transition frequency

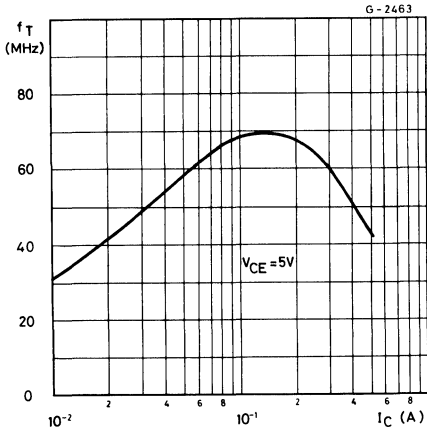

Collector-base capacitance

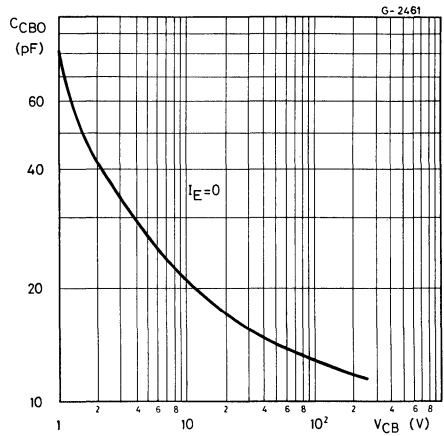

Saturated switching characteristics

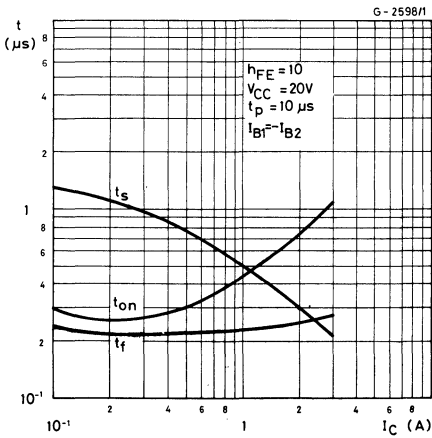

Power rating chart

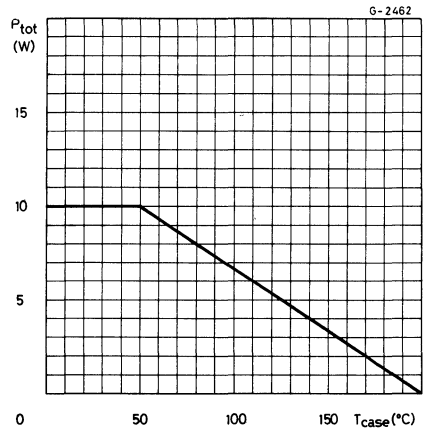

HIGH CURRENT, GENERAL PURPOSE TRANSISTOR

The BUY 68 is a silicon epitaxial planar NPN transistor in Jedec TO-39 metal case. It is used for high-current switching applications and in power amplifiers. The BUY 68 is available in 3 h_{FE} gain bands.

ABSOLUTE MAXIMUM RATINGS

V_{CBO}	Collector-base voltage ($I_E = 0$)	100	V
V_{CER}	Collector-emitter voltage ($R_{BE} \leq 10 \Omega$)	80	V
V_{CEO}	Collector-emitter voltage ($I_B = 0$)	60	V
V_{EBO}	Emitter-base voltage ($I_C = 0$)	6	V
I_C	Collector current	7	A
P_{tot}	Total power dissipation at $T_{amb} \leq 25^\circ\text{C}$ $T_{case} \leq 50^\circ\text{C}$	1	W
		10	W
T_{stg}	Storage temperature	-65 to 200	$^\circ\text{C}$
T_j	Junction temperature	200	$^\circ\text{C}$

INTERNAL SCHEMATIC DIAGRAM

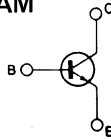

MECHANICAL DATA

Dimensions in mm

Collector connected to case

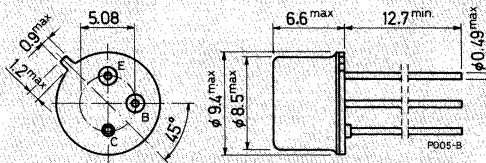

TO-39



THERMAL DATA

$R_{th\ j-case}$	Thermal resistance junction-case	max	15	°C/W
$R_{th\ j-amb}$	Thermal resistance junction-ambient	max	175	°C/W

ELECTRICAL CHARACTERISTICS ($T_{case} = 25^{\circ}C$ unless otherwise specified)

Parameter	Test conditions	Min.	Typ.	Max.	Unit	
I_{CBO}	Collector cutoff current ($I_E = 0$)	1			μA	
$V_{(BR)\ CBO}^*$	Collector-base breakdown voltage ($I_E = 0$)	100			V	
$V_{CER\ (sus)}^*$	Collector-emitter sustaining voltage ($R_{BE} = 10\ \Omega$)	80			V	
$V_{CEO\ (sus)}^*$	Collector-emitter sustaining voltage ($I_B = 0$)	60			V	
V_{EBO}^*	Emitter-base voltage ($I_C = 0$)	6			V	
$V_{CE\ (sat)}^*$	Collector-emitter saturation voltage	$I_C = 2\ A$ $I_C = 5\ A$	$I_B = 0.2\ A$ $I_B = 0.5\ A$	0.6 1	V V	
$V_{BE\ (sat)}^*$	Base-emitter saturation voltage	$I_C = 2\ A$ $I_C = 5\ A$	$I_B = 0.2\ A$ $I_B = 0.5\ A$	1 1.2	1.3 1.6	V V
h_{FE}^*	DC current gain	$I_C = 0.1\ A$	$V_{CE} = 1\ V$ Group 6 Group 10 Group 16	40 40 63 100	130 70 110 170	— — — —
		$I_C = 1\ A$	$V_{CE} = 1\ V$ Group 6 Group 10 Group 16	40 40 63 100	130 70 110 160	— — — —
f_T	Transition frequency	$I_C = 0.5\ A$	$V_{CE} = 5\ V$	50		MHz
C_{CBO}	Collector-base capacitance	$I_E = 0$ $f = 1\ MHz$	$V_{CB} = 10\ V$	80		pF
t_{on}	Turn-on time	$I_C = 5\ A$	$V_{CC} = 20\ V$	0.35		μs
t_{off}	Turn-off time	$I_{B1} = -I_{B2} = 0.5\ A$		0.75		μs

* Pulsed: pulse duration = 300 μs , duty cycle = 1.5%



BUY68

Safe operating areas

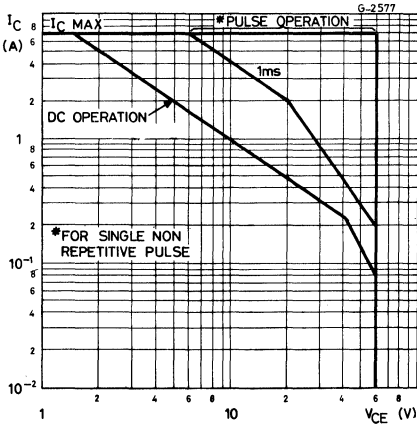

DC current gain

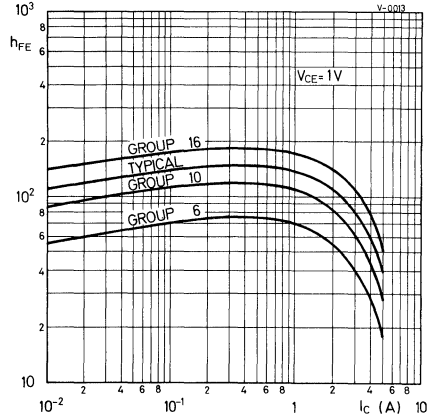

Collector-emitter saturation voltage

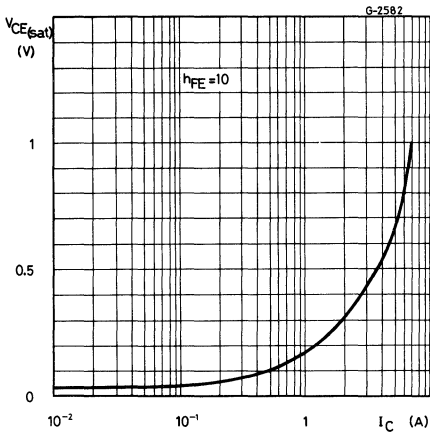

Base-emitter saturation voltage

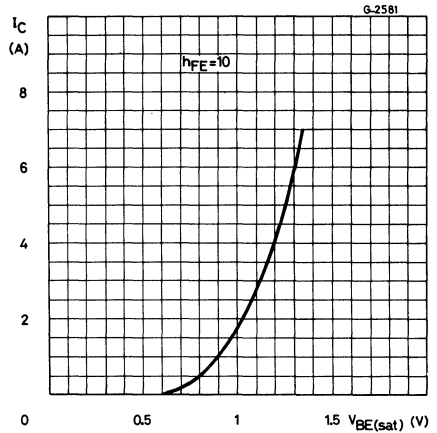

Transition frequency

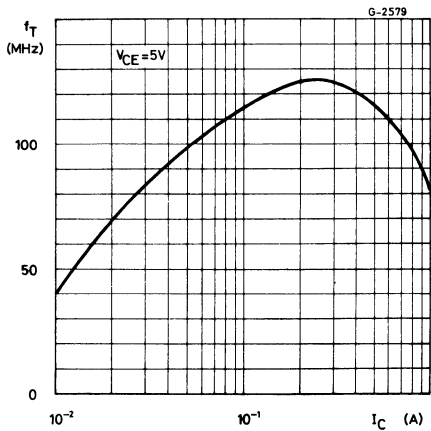

Collector-base capacitance

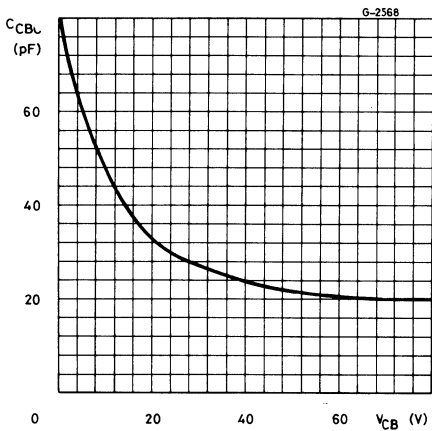

Saturated switching characteristics

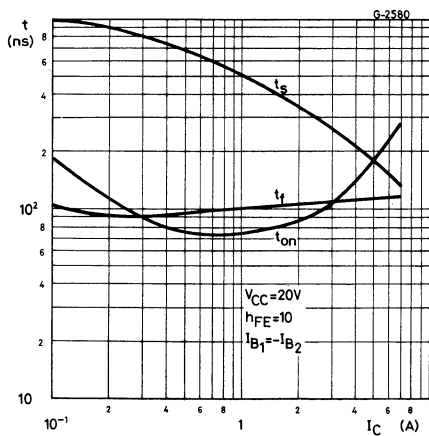

Power rating chart

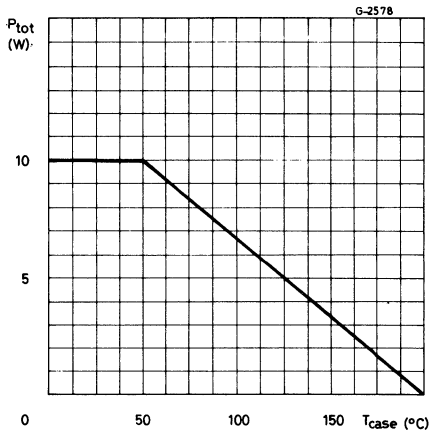



BUY69A
BUY69B
BUY69C

MULTIEPITAXIAL MESA NPN

HIGH VOLTAGE POWER SWITCH

The BUY 69A, BUY 69B, and BUY 69C are silicon multiepitaxial mesa NPN transistors in Jedec TO-3 metal case. They are intended for horizontal deflection output stage of CTV receivers and high voltage, fast switching and industrial applications.

ABSOLUTE MAXIMUM RATINGS

		BUY 69A	BUY 69B	BUY 69C
V_{CES}	Collector-emitter voltage ($V_{BE} = 0$)	1000V	800V	500V
V_{CEO}	Collector-emitter voltage ($I_B = 0$)	400V	325V	200V
V_{EBO}	Emitter-base voltage ($I_C = 0$)		8V	
I_C	Collector current		10A	
I_{CM}	Collector peak current ($t_p \leq 10ms$)		15A	
I_B	Base current		3A	
P_{tot}	Total power dissipation at $T_{case} \leq 25^\circ C$		100W	
T_{stg}	Storage temperature		-65 to 200°C	
T_j	Junction temperature		200°C	

INTERNAL SCHEMATIC DIAGRAM

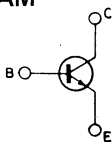

MECHANICAL DATA

Dimensions in mm

Collector connected to case

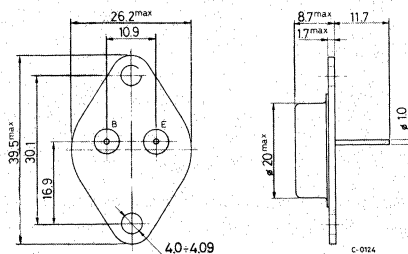

TO-3



THERMAL DATA

$R_{th\ j-case}$	Thermal resistance junction-case	max	1.75	°C/W
------------------	----------------------------------	-----	------	------

ELECTRICAL CHARACTERISTICS ($T_{case} = 25^{\circ}C$ unless otherwise specified)

Parameter	Test conditions	Min.	Typ.	Max.	Unit
I_{CES}	Collector cutoff current ($V_{BE} = 0$)	for BUY 69A for BUY 69B for BUY 69C	$V_{CE} = 1000V$ $V_{CE} = 800V$ $V_{CE} = 500V$	1 1 1	mA mA mA
I_{EBO}	Emitter cutoff current ($I_C = 0$)	$V_{EB} = 8V$		1	mA
V_{CBO}	Collector-base voltage ($I_E = 0$)	for BUY 69A for BUY 69B for BUY 69C	$I_C = 1mA$ $I_C = 1mA$ $I_C = 1mA$	1000 800 500	V V V
$V_{CEO(sus)}$	*Collector-emitter sustaining voltage ($I_B = 0$)	$I_C = 100mA$ for BUY 69A for BUY 69B for BUY 69C		400 325 200	V V V
$V_{CE(sat)}$	* Collector-emitter saturation voltage	$I_C = 8A$	$I_B = 2.5A$	3.3	V
$V_{BE(sat)}$	* Base-emitter saturation voltage	$I_C = 8A$	$I_B = 2.5A$	2.2	V
h_{FE}	* DC current gain	$I_C = 2.5A$	$V_{CE} = 10V$	15	—
f_T	Transition frequency	$I_C = 0.5A$	$V_{CE} = 10V$	10	MHZ
$I_{S/b}$	** Second breakdown collector current	$V_{CE} = 25V$		4	A
t_{on}	Turn-on time	$I_C = 5A$ $I_{B1} = 1A$	$V_{CE} = 250V$	0.2	μS

ELECTRICAL CHARACTERISTICS (continued)

Parameter		Test conditions	Min. Typ. Max.	Unit
t_s	Storage time	$I_C = 5A$ $V_{CE} = 250V$	1.7	μS
t_f	Fall time	$I_{B1} = -I_{B2} = 1A$	0.3	μS
t_f	Fall time	$I_C = 8A$ $V_{CE} = 40V$ $I_{B1} = -I_{B2} = 2.5A$	1	μS

* Pulsed: pulse duration = $300\mu S$, duty cycle = 1.5%

** Pulsed: 1s, non repetitive pulse

For characteristics curves see the BUW 34/5/6 series.

MULTIEPITAXIAL PLANAR NPN



LINEAR AND SWITCHING APPLICATIONS

The D44C1 to D44C12 are silicon multiepitaxial planar transistors in TO-220 plastic package intended for linear and switching applications.

ABSOLUTE MAXIMUM RATINGS

		D44C 1/2/3	D44C 4/5/6	D44C 7/8/9	D44C 10/11/12
V_{CES}	Collector-emitter voltage ($V_{BE} = 0$)	40V	55V	70V	90V
V_{CEO}	Collector-emitter voltage ($I_B = 0$)	30V	45V	60V	80V
V_{EBO}	Emitter-base voltage ($I_C = 0$)	5V	5V	5V	5V
I_C	Collector current	4A			
I_{CM}	Collector peak current ($t_p = 10ms$)	6A			
P_{tot}	Total power dissipation $T_{case} \leq 25^\circ C$ $T_{amb} \leq 25^\circ C$	30W			
T_{stg}	Storage temperature	-55 to 150°C			
T_j	Junction temperature	150°C			

INTERNAL SCHEMATIC DIAGRAM

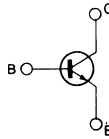

MECHANICAL DATA

Dimensions in mm

Collector connected to tab.

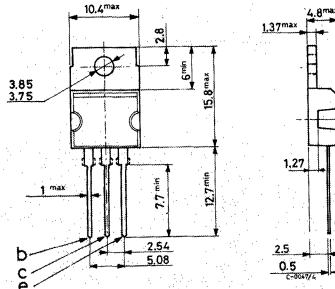

TO-220



THERMAL DATA

$R_{th\ j-case}$	Thermal resistance junction-case	max.	4.2	°C/W
$R_{th\ j-amb}$	Thermal resistance junction-ambient	max.	75	°C/W

ELECTRICAL CHARACTERISTICS ($T_{case} = 25^{\circ}C$ unless otherwise specified)

Parameter	Test conditions	Min.	Typ.	Max.	Unit
I_{CES}	Collector cutoff current ($V_{BE} = 0$)			10	μA
I_{EBO}^*	Emitter cutoff current ($I_C = 0$)			100	μA
$V_{CEO(sus)}^*$	Collector-emitter sustaining voltage	$I_C = 100mA$ for D44C1-2-3 for D44C4-5-6 for D44C7-8-9 for D44C10-11-12		30 45 60 80	V V V V
$V_{CE(sat)}^*$	Collector-emitter saturation voltage	$I_C = 1A$ $I_B = 50mA$ for D44C2-3-5-6-8-9-11-12 $I_C = 1A$ $I_B = 0.1A$ for D44C1-4-7-10		0.5 0.5	V V
$V_{BE(sat)}^*$	Base-emitter saturation voltage	$I_C = 1A$	$I_B = 100mA$	1.3	V
h_{FE}^*	DC current gain	$I_C = 0.2A$ $V_{CE} = 1V$ $I_C = 2A$ $V_{CE} = 1V$ for D44C3-6-9-12 $I_C = 0.2A$ $V_{CE} = 1V$ $I_C = 1A$ $V_{CE} = 1V$ for D44C2-5-8-11 $I_C = 0.2A$ $V_{CE} = 1V$ $I_C = 1A$ $V_{CE} = 1V$ for D44C1-4-7-10		40 20 100 20 25 10	120 — 220 — — —

* Pulsed: pulse duration = 300 μs , duty cycle = 2%.

MULTIEPITAXIAL PLANAR NPN



SWITCHING APPLICATIONS GENERAL PURPOSE

The D44H series are silicon multiepitaxial planar transistors and are mounted in Jedec TO-220 plastic package.

They are intended for various switching and general purpose applications.

ABSOLUTE MAXIMUM RATINGS

ABSOLUTE MAXIMUM RATINGS		D44H1/2	D44H4/5	D44H7/8	D44H10/11
V_{CEO}	Collector-emitter voltage ($I_B = 0$)	30V	45V	60V	80V
V_{EBO}	Emitter base voltage ($I_C = 0$)			5V	
I_C	Collector current			10A	
I_{CM}	Collector peak current			20A	
P_{tot}	Total power dissipation $T_{case} \leq 25^\circ C$			50W	
T_{stg}	Storage temperature			-55 to 150°C	
T_j	Junction temperature			150°C	

INTERNAL SCHEMATIC DIAGRAM

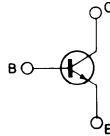

MECHANICAL DATA

Dimensions in mm

Collector connected to tab.

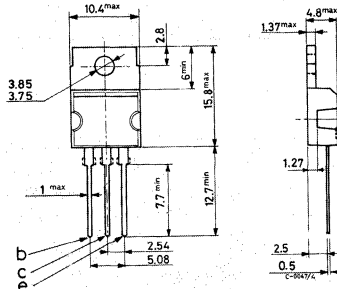

TO-220



THERMAL DATA

$R_{th\ j-case}$	Thermal resistance junction-case	max. 2.5	°C/W
------------------	----------------------------------	----------	------

ELECTRICAL CHARACTERISTICS ($T_{case} = 25^{\circ}C$ unless otherwise specified)

Parameter	Test conditions	Min.	Typ.	Max.	Unit
I_{CBO} Collector cutoff current ($I_E = 0$)	$V_{CB} = \text{Rated } V_{CEO}$			10	μA
I_{EBO} Emitter cutoff current ($I_C = 0$)	$V_{EB} = \text{Rated } V_{EBO}$			100	μA
$V_{CEO(sus)}$ * Collector-emitter sustaining voltage	$I_C = 100mA$ for D44H1/2 for D44H4/5 for D44H7/8 for D44H10/11	30 45 60 80			V V V V
$V_{CE(sat)}$ * Collector-emitter saturation voltage	$I_C = 8A$ $I_B = 0.4A$ for D44H2/5/8/11 $I_C = 8A$ $I_B = 0.8A$ for D44H1/4/7/10			1 1	V V
$V_{BE(sat)}$ * Base-emitter saturation voltage	$I_C = 8A$ $I_B = 0.8A$			1.5	V
h_{FE} * DC current gain	$V_{CE} = 1V$ $I_C = 2A$ for D44H1/4/7/10 for D44H2/5/8/11 $V_{CE} = 1V$ $I_C = 4A$ for D44H1/4/7/10 for D44H2/5/8/11		35 60		-- -- -- --

* Pulsed: pulse duration = 300 μs , duty cycle = 1.5%.

MULTIEPITAXIAL PLANAR NPN

LINEAR AND SWITCHING APPLICATIONS

The D44Q1, D44Q3 and D44Q5 are silicon multiepitaxial planar transistors in TO-220 plastic package intended for linear and switching applications.

ABSOLUTE MAXIMUM RATINGS

		D44Q1	D44Q3	D44Q5
V_{CBO}	Collector-base voltage ($I_E = 0$)	200V	250V	300V
V_{CEO}	Collector-emitter voltage ($I_B = 0$)	125V	175V	225V
V_{EBO}	Emitter-base voltage ($I_B = 0$)	7V	7V	7V
I_C	Collector current		4A	
P_{tot}	Total power dissipation	$T_{case} \leq 25^\circ C$ $T_{amb} \leq 25^\circ C$	31.25W	
			1.67W	
T_{stg}	Storage temperature	-55 to 150°C		
T_j	Junction temperature	150°C		

INTERNAL SCHEMATIC DIAGRAM

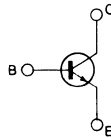

MECHANICAL DATA

Dimensions in mm

Collector connected to tab.

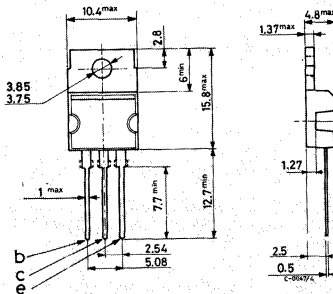

TO-220



THERMAL DATA

$R_{th\ j-case}$	Thermal resistance junction-case	max.	4	°C/W
$R_{th\ j-amb.}$	Thermal resistance junction-ambient	max.	75	°C/W

ELECTRICAL CHARACTERISTICS ($T_{case} = 25^{\circ}C$ unless otherwise specified)

Parameter	Test conditions	Min.	Typ.	Max.	Unit
I_{CBO}	Collector cutoff current ($I_E = 0$)			10	μA
$V_{CEO(sus)}$	Collector emitter sustaining voltage				
	$I_C = 10mA$				
	for D44Q1	125			V
	for D44Q3	175			V
	for D44Q5	225			V
$V_{CE(sat)}$	Collector-emitter saturation voltage			1	V
	$I_C = 2A$ $I_B = 0.2A$				
$V_{BE(sat)}$	Base-emitter saturation voltage			1.3	V
	$I_C = 2A$ $I_B = 0.2A$				
h_{FE}	DC current gain				—
	$I_C = 0.2A$ $V_{CE} = 10V$	30			—
	$I_C = 2A$ $V_{CE} = 10V$	20			—
f_T	Transition frequency			20	MHz
	$I_C = 100mA$ $V_{CE} = 10V$				
C_{CBO}	Collector base capacitance			32	pF
	$V_{CB} = 10V$ $f = 1MHz$				
t_{on}	Turn-in time			0.4	μs
	$V_{CC} = 50V$ $I_C = 1A$ $I_{B1} = -I_{B2} = 0.1A$				
t_s		Storage time		2	μs
t_f		Fall time		1.7	μs

* Pulsed: pulse duration = 300 μs , duty cycle = 2%.

EPITAXIAL-BASE NPN/PNP



COMPLEMENTARY POWER DARLINGTONS

The MJ 900, MJ 901, MJ 1000 and MJ 1001 are silicon epitaxial-base transistors in monolithic Darlington configuration, and are mounted in Jeced TO-3 metal case. They are intended for use in power linear and switching applications. The PNP types are the MJ 900 and MJ 901 and their complementary NPN types are the MJ 1000 and MJ 1001 respectively.

ABSOLUTE MAXIMUM RATINGS

		PNP°	MJ 900	MJ 901
		NPN	MJ1000	MJ1001
V_{CBO}	Collector-base voltage ($I_E = 0$)		60V	80V
V_{CEO}	Collector-emitter voltage ($I_B = 0$)		60V	80V
V_{EBO}	Emitter-base voltage ($I_C = 0$)		5V	
I_C	Collector current		8A	
I_B	Base current		0.1A	
P_{tot}	Total power dissipation at $T_{case} \leq 25^\circ C$		90W	
T_{stg}	Storage temperature		-65 to 200 °C	
T_j	Junction temperature		200 °C	

° For PNP types voltage and current values are negative

MECHANICAL DATA

Dimensions in mm

Collector connected to case

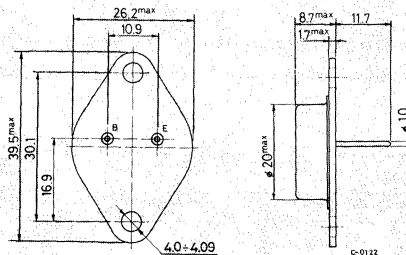

TO-3



**MJ900
MJ901
MJ1000
MJ1001**

THERMAL DATA

$R_{th\ j-case}$	Thermal resistance junction-case	max	1.94	°C/W
------------------	----------------------------------	-----	------	------

ELECTRICAL CHARACTERISTICS ° ($T_{case} = 25^{\circ}C$ unless otherwise specified)

Parameter	Test conditions	Min.	Typ.	Max.	Unit
I_{CER} Collector cutoff current ($R_{BE} = 1k\Omega$)	for MJ900 and MJ1000 $V_{CE} = 60\ V$			1	mA
	for MJ901 and MJ1001 $V_{CE} = 80\ V$			1	mA
	$T_{case} = 150^{\circ}C$ for MJ900 and MJ1000 $V_{CE} = 60\ V$			5	mA
	for MJ901 and MJ1001 $V_{CE} = 80\ V$			5	mA
I_{CEO} Collector cutoff current ($I_B = 0$)	for MJ900 and MJ1000 $V_{CE} = 30\ V$			0.5	mA
	for MJ901 and MJ1001 $V_{CE} = 40\ V$			0.5	mA
I_{EBO} Emitter cutoff current ($I_C = 0$)	$V_{EB} = 5\ V$			2	mA
$V_{CEO(sus)}^*$ Collector-emitter sustaining voltage ($I_B = 0$)	$I_C = 100mA$ for MJ900 and MJ1000 for MJ901 and MJ1001	60			V
		80			V
$V_{CE(sat)}^*$ Collector-emitter saturation voltage	$I_C = 3\ A$			2	V
	$I_C = 8\ A$	$I_B = 12mA$ $I_B = 40mA$		4	V
V_{BE}^* Base-emitter voltage	$I_C = 3\ A$	$V_{CE} = 3\ V$		2.5	V
h_{FE}^* DC current gain	$I_C = 3\ A$	$V_{CE} = 3\ V$	1000		—
	$I_C = 4\ A$	$V_{CE} = 3\ V$	750		—

* Pulsed: pulse duration = 300 μs , duty cycle = 1.5%

° For PNP types current and voltage values are negative

For characteristic curves see the 2N 6053/55 series

EPITAXIAL-BASE NPN/PNP



COMPLEMENTARY POWER DARLINGTONS

The MJ 2500, MJ 2501, MJ 3000 and MJ 3001 are silicon epitaxial-base transistors in monolithic Darlington configuration and are mounted in Jecdec TO-3 metal case. They are intended for use in power linear and switching applications.

The PNP types are the MJ 2500 and MJ 2501 and the complementary NPN types are the MJ 3000 and MJ 3001 respectively.

ABSOLUTE MAXIMUM RATINGS

		PNP°	MJ2500	MJ2501
		NPN	MJ3000	MJ3001
V_{CBO}	Collector-base voltage ($I_E = 0$)		60V	80V
V_{CEO}	Collector-emitter voltage ($I_B = 0$)		60V	80V
V_{EBO}	Emitter-base voltage ($I_C = 0$)			5V
I_C	Collector current			10A
I_B	Base current			0.2A
P_{tot}	Total power dissipation at $T_{case} \leq 25^\circ C$			150W
T_{stg}	Storage temperature			-65 to 200 °C
T_j	Junction temperature			200 °C

° For PNP types voltage and current values are negative

MECHANICAL DATA

Dimensions in mm

Collector connected to case

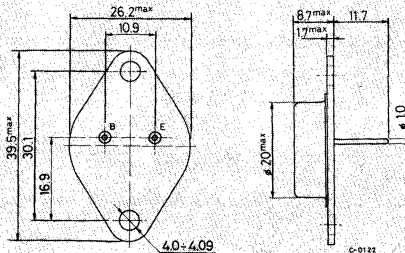

TO-3



MJ2500
MJ2501
MJ3000
MJ3001

THERMAL DATA

$R_{th\ j-case}$	Thermal resistance junction-case	max	1.17 °C/W
------------------	----------------------------------	-----	-----------

ELECTRICAL CHARACTERISTICS ° ($T_{case} = 25\text{ °C}$ unless otherwise specified)

Parameter	Test conditions	Min.	Typ.	Max.	Unit
I_{CER}	Collector cutoff current ($R_{BE} = 1k\Omega$) for MJ2500 and MJ3000 $V_{CE} = 60\text{ V}$ for MJ2501 and MJ3001 $V_{CE} = 80\text{ V}$ $T_{case} = 150\text{ °C}$ for MJ2500 and MJ3000 $V_{CE} = 60\text{ V}$ for MJ2501 and MJ3001 $V_{CE} = 80\text{ V}$			1	mA
				1	mA
				5	mA
				5	mA
I_{CEO}	Collector cutoff current ($I_B = 0$) for MJ2500 and MJ3000 $V_{CE} = 30\text{ V}$ for MJ2501 and MJ3001 $V_{CE} = 40\text{ V}$			1	mA
				1	mA
I_{EBO}	Emitter cutoff current ($I_C = 0$) $V_{EB} = 5\text{ V}$			2	mA
$V_{CEO(sus)}^*$	Collector-emitter sustaining voltage ($I_B = 0$) $I_C = 100\text{ mA}$ for MJ2500 and MJ3000 for MJ2501 and MJ3001	60			V
		80			V
$V_{CE(sat)}^*$	Collector-emitter saturation voltage $I_C = 5\text{ A}$ $I_B = 20\text{ mA}$ $I_C = 10\text{ A}$ $I_B = 50\text{ mA}$			2	V
				4	V
V_{BE}^*	Base-emitter voltage $I_C = 5\text{ A}$ $V_{CE} = 3\text{ V}$			3	V
h_{FE}^*	DC current gain $I_C = 5\text{ A}$ $V_{CE} = 3\text{ V}$	1000			—

* Pulsed: pulse duration = 300 μs , duty cycle = 1.5%

° For PNP types current and voltage values are negative

For characteristic curves see the 2N6050 / 57 series



EPITAXIAL-BASE PNP

POWER LINEAR AND SWITCHING APPLICATIONS

The MJ 2955 is a silicon epitaxial-base PNP power transistor in Jedec TO-3 metal case. It is intended for power switching circuits, series and shunt regulators, output stages and hi-fi amplifiers.

ABSOLUTE MAXIMUM RATINGS

V_{CB0}	Collector-base voltage ($I_E = 0$)	-100	V
V_{CER}	Collector-emitter voltage ($R_{BE} \leq 100 \Omega$)	-70	V
V_{CEO}	Collector-emitter voltage ($I_B = 0$)	-60	V
V_{EBO}	Emitter-base voltage ($I_C = 0$)	-7	V
I_C	Collector current	-15	A
I_B	Base current	-7	A
P_{tot}	Total power dissipation at $T_{case} \leq 25^\circ C$	150	W
T_{stg}	Storage temperature	-65 to 200	$^\circ C$
T_j	Junction temperature	200	$^\circ C$

INTERNAL SCHEMATIC DIAGRAM

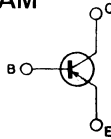

MECHANICAL DATA

Dimensions in mm

Collector connected to case

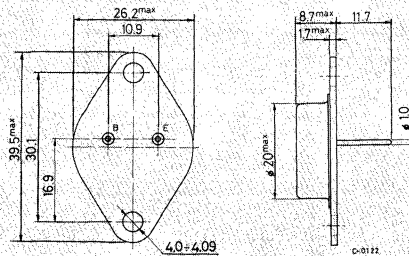

TO-3

**MJ2955****THERMAL DATA**

$R_{th\ j-case}$	Thermal resistance junction-case	max	1.17	°C/W
------------------	----------------------------------	-----	------	------

ELECTRICAL CHARACTERISTICS ($T_{case} = 25\text{ °C}$ unless otherwise specified)

Parameter	Test conditions	Min.	Typ.	Max.	Unit
I_{CEX}	Collector cutoff current ($V_{BE} = 1.5V$)	$V_{CE} = -100V$ $V_{CE} = -100V$		-1 -5	mA mA
I_{CEO}	Collector cutoff current ($I_B = 0$)	$V_{CE} = -30\text{ V}$		-0.7	mA
I_{EBO}	Emitter cutoff current ($I_C = 0$)	$V_{BE} = 7\text{ V}$		-5	mA
$V_{CEr(sus)}$ *	Collector-emitter sustaining voltage ($R_{BE} = 100\ \Omega$)	$I_C = -200mA$		-70	V
$V_{CEO(sus)}$ *	Collector-emitter sustaining voltage ($I_B = 0$)	$I_C = -200mA$		-60	V
$V_{CE(sat)}$ *	Collector-emitter saturation voltage	$I_C = -4\text{ A}$ $I_C = -10\text{ A}$	$I_B = -0.4A$ $I_B = -3.3A$	-1.1 -3	V V
V_{BE} *	Base-emitter voltage	$I_C = -4\text{ A}$	$V_{CE} = -4\text{ V}$	-1.8	V
h_{FE} *	DC current gain	$I_C = -4\text{ A}$ $I_C = -10\text{ A}$	$V_{CE} = -4\text{ V}$ $V_{CE} = -4\text{ V}$	20 5	70 —
f_T	Transition frequency	$I_C = -0.5A$	$V_{CE} = -10V$	4	MHz

* Pulsed: pulse duration = 300 μs , duty cycle = 1.5%

For characteristic curves see the 2N 5875 series

EPITAXIAL-BASE NPN/PNP



GENERAL PURPOSE

The MJ4030/31/32/33/34/35 are medium-power silicon Darlington in Jedec TO-3 metal case, intended for use in general purpose and amplifier applications.

ABSOLUTE MAXIMUM RATINGS

		NPN PNP*	MJ4030 MJ4033	MJ4031 MJ4034	MJ4032 MJ4035
V_{CBO}	Collector-base voltage ($I_E = 0$)		60V	80V	100V
V_{CEO}	Collector-emitter voltage ($I_B = 0$)		60V	80V	100V
V_{EBO}	Emitter-base voltage ($I_C = 0$)			5V	
I_C	Collector current			16A	
I_B	Base current			0.5A	
P_{tot}	Total power dissipation at $T_{case} \leq 25^\circ C$			150W	
T_{stg}	Storage temperature			-65 to 200°C	
T_j	Junction temperature			200°C	

* For NPN types voltage and current values are negative

INTERNAL SCHEMATIC DIAGRAMS

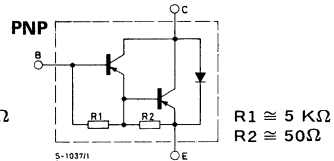
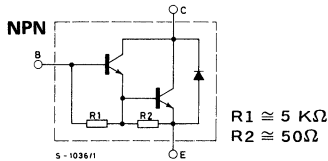

MECHANICAL DATA

Dimensions in mm

Collector connected to case

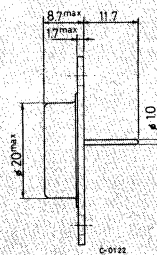
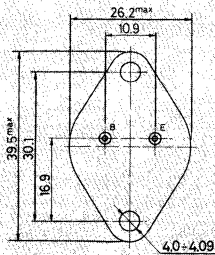

TO-3



THERMAL DATA

$R_{th\ j-case}$ Thermal resistance junction-case	max. 1.17 °C/W
---	----------------

ELECTRICAL CHARACTERISTICS ($T_{case} = 25^{\circ}C$ unless otherwise specified)

Parameter	Test conditions	Min.	Typ.	Max.	Unit
I_{CEO} Collector cutoff current ($I_B = 0$)	$V_{CE} = 30V$ $I_B = 0$ MJ4030/33			3	mA
	$V_{CE} = 40V$ $I_B = 0$ MJ4031/34			3	mA
	$V_{CE} = 50V$ $I_B = 0$ MJ4032/35			3	mA
I_{EBO} Emitter cutoff current ($I_C = 0$)	$V_{BE} = 5V$ $I_C = 0$			5	mA
I_{CER} Collector cutoff current ($R_{BE} = 1K\Omega$)	for MJ4030/33 $V_{CB} = 60V$			1	mA
	for MJ4031/34 $V_{CB} = 80V$			1	mA
	for MJ4032/35 $V_{CB} = 100V$			1	mA
	$T_{case} = 150^{\circ}C$ for MJ4030/33 $V_{CB} = 60V$			5	mA
	for MJ4031/34 $V_{CB} = 80V$			5	mA
for MJ4032/35 $V_{CB} = 100V$			5	mA	
$V_{(BR)CEO}^*$ Collector-emitter Breakdown voltage	$I_C = 100mA$ $I_B = 0$				
	for MJ4030/33	60			V
	for MJ4031/33	80			V
for MJ4032/35	100			V	
$V_{CE(sat)}^*$ Collector-emitter saturation voltage	$I_C = 10A$ $I_B = 40mA$			2.5	V
	$I_C = 16A$ $I_B = 80mA$			4	V
V_{BE}^* Base-emitter voltage	$I_C = 10A$ $V_{CE} = 3V$			3	V
h_{FE}^* DC Current gain	$I_C = 10A$ $V_{CE} = 3V$	1000			—

* Pulsed: pulse duration = 300 μs , duty cycles $\leq 2\%$.

For PNP types voltage and current values are negative.

EPITAXIAL PLANAR NPN



HIGH POWER FAST SWITCHING

The MJ10004/10005 are silicon darlington transistors with integrated base-emitter speed-up diode, mounted in Jedec TO-3 metal case designed for high-power, fast switching applications. The MJ10004P and MJ10005P are mounted in SOT-93 case similar to TO-218.

ABSOLUTE MAXIMUM RATINGS

		MJ10004/5	MJ1004P/5P
V_{CE0}	Collector-emitter voltage ($I_B = 0$)	350V	400V
V_{CEX}	Collector-emitter voltage ($V_{BE} = -5V$)	400V	450V
V_{CEV}	Collector-emitter voltage ($V_{BE} = 1,5V$)	450V	500V
V_{EBO}	Emitter-base voltage ($I_C = 0$)		8V
I_C	Collector current		20A
I_{CM}	Collector peak current		30A
I_B	Base current		2.5A
I_{BM}	Base peak current		5A
P_{tot}	Total power dissipation at $T_{case} \leq 25^\circ C$	TO-3 175W	SOT-93 150W
T_{stg}	Storage temperature	-65 to 200°C	-65 to 175°C
T_j	Junction temperature	200°C	175°C

INTERNAL SCHEMATIC DIAGRAM

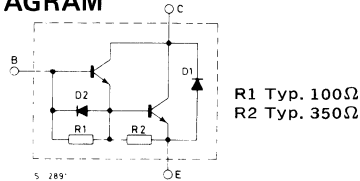

MECHANICAL DATA

Dimensions in mm

Collector connected to case

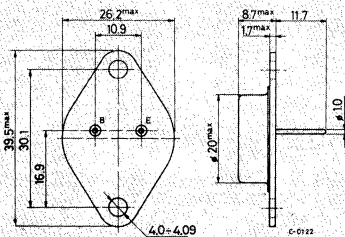

TO-3

Collector connected to tab.

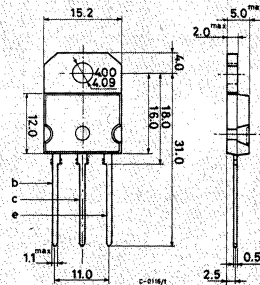

(sim. to TO-218) SOT-93

THERMAL DATA

$R_{th\ j-case}$	Thermal resistance junction-case	max. 1 °C/W
------------------	----------------------------------	-------------

ELECTRICAL CHARACTERISTICS ($T_{case} = 25^{\circ}C$ unless otherwise specified)

Parameter	Test conditions	Min.	Typ.	Max.	Unit	
I_{CER}	Collector cutoff current ($R_{BE} = 50\Omega$)			5	mA	
I_{CEV}	Collector cutoff current ($V_{BE} = 1.5V$)			0.25	mA	
				5	mA	
I_{EBO}	Emitter cutoff current ($I_C = 0$)			175	mA	
$V_{CEO(sus)}$ *	Collector-emitter sustaining voltage ($I_B = 0$)					
	$I_C = 250mA$ $V_{Clamp} = \text{Rated } V_{CEO}$ for MJ10004 for MJ10005	350		400	V V	
$V_{CEX(sus)}$ *	Collector-emitter sustaining voltage ($V_{BE} = -5V$)					
		$I_C = 2A$ $V_{Clamp} = \text{Rated } V_{CEX}$ $T_{case} = 100^{\circ}C$ for MJ10004 for MJ10005	400		450	V V
		$I_C = 10A$ $T_{case} = 100^{\circ}C$ $V_{Clamp} = \text{Rated } V_{CEX}$ for MJ10004 for MJ10005	275		325	V V
$V_{CE(sat)}$ *	Collector-emitter saturation voltage	$I_C = 10A$ $I_B = 400mA$		1.9	V	
		$I_C = 20A$ $I_B = 2A$		(°)3	V	
		$I_C = 10A$ $I_B = 400mA$				
		$T_{case} = 100^{\circ}C$		2.5	V	
$V_{BE(sat)}$ *	Base-emitter saturation voltage	$I_C = 10A$ $I_B = 400mA$		2.5	V	
		$I_C = 10A$ $I_B = 400mA$				
		$T_{case} = 100^{\circ}C$		2.5	V	

(°) For MJ10004P/5P = 5V max.

ELECTRICAL CHARACTERISTICS ($T_{\text{case}} = 25^{\circ}\text{C}$ unless otherwise specified)

Parameter		Test conditions	Min.	Typ.	Max.	Unit
h_{FE}^*	DC current gain	$I_C = 5A$	50	600	—	—
		$I_C = 10A$	40	400	—	—
V_f^*	Diode forward voltage	$I_F = 10A$	3	5		V
h_{fe}	Small-signal current gain	$I_C = 1A$ $V_{CE} = 10V$ $f_{\text{test}} = 1\text{MHz}$	10			—
C_{ob}	Output capacitance	$V_{CB} = 10V$ $I_E = 0$ $f_{\text{test}} = 100\text{MHz}$	100	325		pF
t_{on}	Turn-on time	$V_{CC} = 250V$ $I_C = 10A$ $I_{B1} = -I_{B2} = 400\text{mA}$ $V_{BE(\text{off})} = 5V$ $t_p = 50\mu\text{s}$ duty cycle -2%	0.22	0.8		μs
t_r	Rise time		0.6	1.5		μs
t_f	Fall time		0.15	0.5		μs

*Pulsed: pulse duration = 300μ duty cycle = 1.5%.



MJ11011/MJ11012
MJ11013/MJ11014
MJ11015/MJ11016

EPITAXIAL-BASE NPN/PNP

GENERAL PURPOSE

The MJ11011/12/13/14/15/16 are silicon transistors in Darlington configuration in Jeduc TO-3 metal-case. Intended for general purpose and amplifier applications.

ABSOLUTE MAXIMUM RATINGS

		PNP*	MJ11011	MJ11013	MJ11015
		NPN	MJ11012	MJ11014	MJ11016
V_{CBO}	Collector-base voltage ($I_E = 0$)		60V	90V	120V
V_{CEO}	Collector-emitter voltage ($I_B = 0$)		60V	90V	120V
V_{EBO}	Base-emitter voltage ($I_C = 0$)			5V	
I_C	Collector current			30A	
I_B	Base current			1A	
P_{tot}	Total power dissipation at $T_{case} \leq 25^\circ C$			200W	
T_{stg}	Storage temperature			-65 to 200°C	
T_j	Junction temperature			200°C	

* For PNP types voltage and current values are negative

INTERNAL SCHEMATIC DIAGRAMS

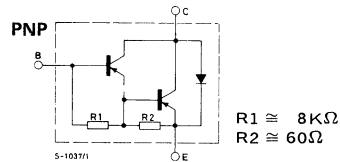
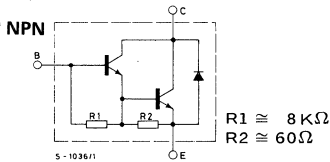

MECHANICAL DATA

Dimensions in mm

Collector connected to case

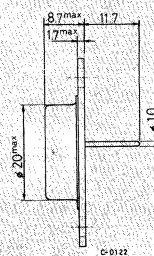
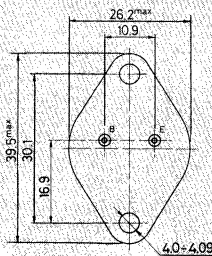

TO-3

THERMAL DATA

$R_{th\ j-case}$	Thermal resistance junction-case	max 0.87 °C/W
------------------	----------------------------------	---------------

ELECTRICAL CHARACTERISTICS ($T_{case} = 25^{\circ}C$ unless otherwise specified)

Parameter	Test conditions	Min. Typ. Max.	Unit
I_{CEO} Collector cutoff current ($I_B = 0$)	$V_{CE} = 50V$	1	mA
I_{EBO} Emitter cutoff current ($I_C = 0$)	$V_{BE} = 5V$	5	mA
I_{CER} Collector cutoff current ($R_{BE} = 1K\Omega$)	for MJ11011/12 $V_{CE} = 60V$	1	mA
	for MJ11013/14 $V_{CE} = 90V$	1	mA
	for MJ11015/16 $V_{CE} = 120V$	1	mA
	$T_{case} = 150^{\circ}C$		
	for MJ11011/12 $V_{CE} = 60V$	5	mA
	for MJ11013/14 $V_{CE} = 90V$	5	mA
	for MJ11015/16 $V_{CE} = 120V$	5	mA
$V_{(BR)CEO}^*$ Collector emitter breakdown voltage	$I_C = 100mA$ $I_B = 0$ for MJ11011/12 for MJ11013/14 for MJ11015/16	60	V
		90	V
		120	V
$V_{CE(sat)}^*$ Collector-emitter saturation voltage	$I_C = 20A$ $I_B = 200mA$	3	V
	$I_C = 30A$ $I_B = 300mA$	4	V
$V_{BE(sat)}^*$ Base-emitter saturation voltage	$I_C = 20A$ $I_B = 200mA$	3.5	V
	$I_C = 30A$ $I_B = 300mA$	5	V
h_{FE}^* DC current gain	$I_C = 20A$ $V_{CE} = 5V$	1000	—
	$I_C = 30A$ $V_{CE} = 5V$	200	—
h_{fe} Small signal current gain	$I_C = 10A$ $V_{CE} = 3V$ $f = 1MHz$	4	

* Pulsed: pulse duration = 300 μs , duty cycle = 1.5%

For PNP devices voltage and current values are negative.



MJE340
MJE350

EPITAXIAL PLANAR NPN/PNP

HIGH VOLTAGE POWER TRANSISTOR

The MJE340/MJE350 are silicon epitaxial planar transistors in jedec TO-126 plastic package intended for use in medium power linear and switching applications.

ABSOLUTE MAXIMUM RATINGS

V_{CEO}	Collector-emitter voltage ($I_B = 0$)	300	V
V_{EBO}	Emitter-base voltage ($I_C = 0$)	3	V
I_C	Collector current	0.5	A
P_{tot}	Total power dissipation at $T_{case} \geq 25^\circ C$	20.8	W
T_{stg}	Storage temperature	-65 to 150	$^\circ C$
T_j	Junction temperature	150	$^\circ C$

For PNP types voltage and current values are negative

INTERNAL SCHEMATIC DIAGRAMS

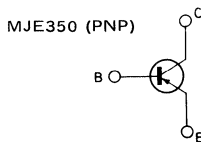
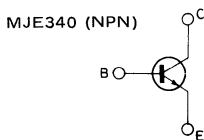

MECHANICAL DATA

Dimensions in mm

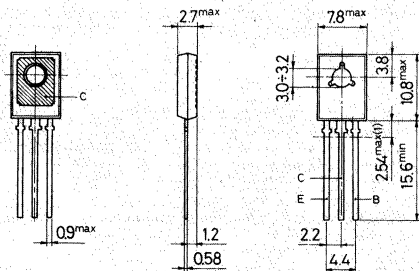

(1) Within this region the cross-section of the leads is uncontrolled

TO-126 (SOT-32)



MJE340
MJE350

THERMAL DATA

$R_{th\ j-case}$ Thermal resistance junction-case	max. 6.0 °C/W
---	---------------

ELECTRICAL CHARACTERISTICS ($T_{case} = 25^{\circ}C$ unless otherwise specified)

Parameter	Test conditions	Min.	Typ.	Max.	Unit
I_{CBO} Collector cutoff current ($I_B = 0$)	$V_{CB} = 300V$			100	μA
I_{EBO} Emitter cutoff current ($I_C = 0$)	$V_{EB} = 3V$			100	μA
$V_{CEO(sus)}^*$ Collector-emitter sustaining voltage ($I_B = 0$)	$I_C = 1mA$	300			V
h_{FE} DC current gain	$I_C = 50mA$ $V_{CE} = 10V$	30		240	—

* Pulsed: pulse duration = 300 μs , duty cycle $\leq 2\%$.

For PNP types voltage and current values are negative.

MEDIUM POWER DARLINGTONS

The MJE 700, MJE 701, MJE 702, MJE 703, MJE 800, MJE 801, MJE 802 and MJE 803 are silicon epitaxial-base power transistors in monolithic Darlington configuration and are mounted in Jedec TO-126 plastic package.

They are intended for use in medium power linear and switching applications.

The PNP types are the MJE 700, MJE 701, MJE 702 and MJE 703 and their complementary NPN types are the MJE 800, MJE 801, MJE 802 and MJE 803.

		PNP ^o	
		MJE700 MJE701	MJE702 MJE703
ABSOLUTE MAXIMUM RATINGS		NPN	
		MJE800 MJE801	MJE802 MJE803
V_{CBO}	Collector-base voltage ($I_E = 0$)	60V	80V
V_{CEO}	Collector-emitter voltage ($I_B = 0$)	60V	80V
V_{EBO}	Emitter-base voltage ($I_C = 0$)		5V
I_C	Collector current		4A
I_B	Base current		0.1A
P_{tot}	Total power dissipation at $T_{case} \leq 25^\circ C$		40W
T_{stg}	Storage temperature		-65 to 150 °C
T_j	Junction temperature		150 °C

^o For PNP devices voltage and current values are negative

MECHANICAL DATA

Dimensions in mm

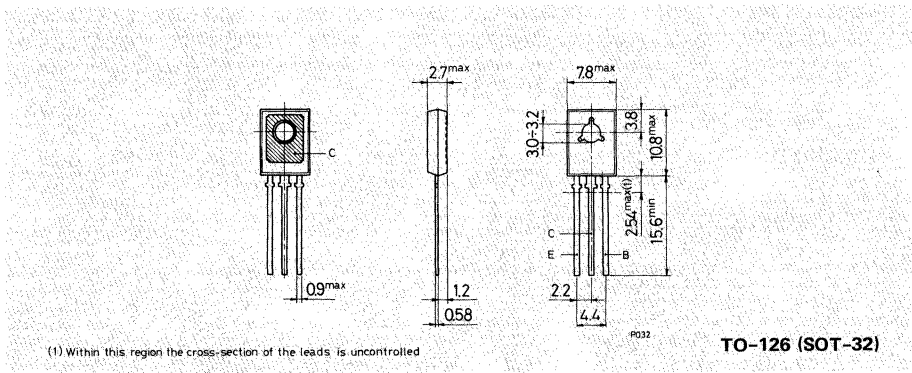



THERMAL DATA

$R_{th\ j-case}$	Thermal resistance junction-case	max	3.13 °C/W
------------------	----------------------------------	-----	-----------

ELECTRICAL CHARACTERISTICS * ($T_{case} = 25\text{ °C}$ unless otherwise specified)

Parameter	Test conditions	Min.	Typ.	Max.	Unit
I_{CBO} Collector cutoff current ($I_E = 0$)	for MJE 700, MJE 800, $V_{CB} = 60\text{ V}$ for MJE 702, MJE 802, $V_{CB} = 80\text{ V}$ for MJE 701, MJE 801, $T_{case} = 100\text{ °C}$ for MJE 703, MJE 803, $T_{case} = 100\text{ °C}$			100 2 200 2	μA μA mA
I_{CEO} Collector cutoff current ($I_B = 0$)	for MJE 700, MJE 800, $V_{CE} = 30\text{ V}$ for MJE 702, MJE 802, $V_{CE} = 40\text{ V}$ MJE 701, MJE 801, MJE 703, MJE 803			100 500	μA μA
I_{EBO} Emitter cutoff current ($I_C = 0$)	$V_{EB} = 5\text{ V}$			2	mA
$V_{CEO(sus)}$ * Collector-emitter sustaining voltage ($I_B = 0$)	for MJE 700, MJE 800, $I_C = 50\text{ mA}$ for MJE 702, MJE 802, $I_C = 50\text{ mA}$ MJE 701, MJE 801, MJE 703, MJE 803			60 80	V V
$V_{CE(sat)}$ * Collector-emitter saturation voltage	for MJE 700, MJE 800, $I_C = 4\text{ A}$ for MJE 701, MJE 801, $I_C = 2\text{ A}$ MJE 702, MJE 802, $I_B = 40\text{ mA}$ MJE 703, MJE 803, $I_B = 40\text{ mA}$			2.7 2.8	V V



ELECTRICAL CHARACTERISTICS (continued)

Parameter	Test conditions	Min.	Typ.	Max.	Unit
V_{BE}^* Base-emitter voltage	for MJE 700, MJE 800, $I_C = 1.5 \text{ A}$ for MJE 701, MJE 801, $I_C = 2 \text{ A}$			2.5	V
	MJE 702, MJE 802 $V_{CE} = 3 \text{ V}$ MJE 703, MJE 803 $V_{CE} = 3 \text{ V}$			2.5	V
h_{FE}^* DC current gain	for MJE 700, MJE 800, $I_C = 4 \text{ A}$ for MJE 701, MJE 801, $I_C = 2 \text{ A}$			110	—
	MJE 702, MJE 802 $V_{CE} = 3 \text{ V}$ MJE 703, MJE 803 $V_{CE} = 3 \text{ V}$			750	—
h_{fe} Small signal current gain	$I_C = 1.5 \text{ A}$ $f = 1 \text{ MHz}$ $V_{CE} = 3 \text{ V}$			1	—

* Pulsed: pulse duration = 300 μs , duty cycle = 1.5%
 ° For PNP devices voltage and current values are negative
For characteristic curves see the 2N 6034/2N 6039 series

MULTIEPITAXIAL BIPLANAR NPN



LINEAR AND SWITCHING APPLICATIONS

The MJE13002 and MJE13003 are silicon multiepitaxial biplanar transistors in TO-126 plastic package intended for linear and switching applications.

ABSOLUTE MAXIMUM RATINGS

		MJE13002	MJE13003
V_{CBO}	Collector-base voltage ($I_E = 0$)	600V	700V
V_{CEO}	Collector-emitter voltage ($I_B = 0$)	300V	400V
V_{EBO}	Emitter-base voltage ($I_C = 0$)		9V
I_C	Collector current		1.5V
$I_{CM}(*)$	Collector peak current		3A
I_B	Base current		0.75A
$I_{BM}(*)$	Base peak current		1.5A
P_{tot}	Total power dissipation at $T_{case} \leq 25^\circ C$ $T_{amb} \leq 25^\circ C$		40W
T_j, T_{stg}	Junction, Storage temperature		1.4W -65 to 150°C

* Pulse width = 5msec., duty cycle $\leq 10\%$.

INTERNAL SCHEMATIC DIAGRAM

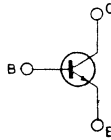

MECHANICAL DATA

Dimensions in mm

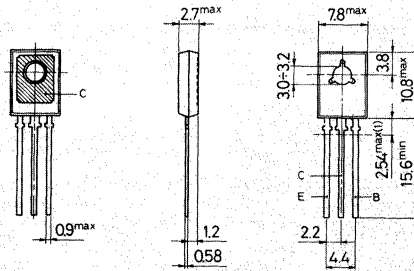

(1) Within this region the cross-section of the leads is uncontrolled

P032

TO-126 (SOT-32)



MJE13002
MJE13003

THERMAL DATA

$R_{th\ j-case}$	Thermal resistance junction-case	max.	3.12	°C/W
$R_{th\ j-amb}$	Thermal resistance junction- ambient	max.	89	°C/W

ELECTRICAL CHARACTERISTICS ($T_{case} = 25^{\circ}C$ unless otherwise specified)

Parameter	Test conditions	Min.	Typ.	Max.	Unit	
I_{CES}	Collector cutoff current ($V_{BE} = 0$)	for MJE13002 for MJE13003 $T_{case} = 100^{\circ}C$ for MJE13002 for MJE13003	$V_{CES} = 600V$ $V_{CES} = 700V$ $V_{CES} = 600V$ $V_{CES} = 700V$	1 1 5 5	mA mA mA mA	
I_{EBO}	Emitter cutoff current ($I_C = 0$)	$V_{EB} = 9V$		1	mA	
$V_{CE(sus)}^*$	Collector-emitter sustaining voltage	$I_C = 10mA$	for MJE13002 for MJE13003	300 400	V V	
$V_{CE(sat)}^*$	Collector-emitter saturation voltage	$I_C = 0.5A$ $I_C = 1A$ $I_C = 1.5A$ $I_C = 1A$ $T_{case} = 100^{\circ}C$	$I_B = 0.1A$ $I_B = 0.25A$ $I_B = 0.5A$ $I_B = 0.25A$	0.5 1 3 1	V V V V	
$V_{BE(sat)}^*$	Base-emitter saturation voltage	$I_C = 0.5A$ $I_C = 1A$ $I_C = 1A$ $T_{case} = 100^{\circ}C$	$I_B = 0.1A$ $I_B = 0.25A$ $I_B = 0.25A$	1 1.2 1.1	V V V	
h_{FE}^*	DC current gain	$I_C = 0.5A$ $I_C = 1A$	$V_{CE} = 2V$ $V_{CE} = 2V$	8 5	40 25	— —
f_T	Transition frequency	$V_{CE} = 10V$ $I_C = 100mA$	$f = 1MHz$	5	10	MHz
C_{CBO}	Collector-base capacitance	$V_{CB} = 10V$		30		pF

ELECTRICAL CHARACTERISTICS (continued)

Parameter	Test conditions	Min.	Typ.	Max.	Unit
t_r	Rise time		0.24	1	μs
t_s	Storage time		1.7	4	μs
t_f	Fall time		0.5	1	μs
t_{sv}	Voltage storage time		0.8	4	μs
t_c	Commutation time		0.1	0.75	μs

Resistive load
 $V_{CC} = 125V$
 $I_C = 1A$
 $I_{B1} = -I_{B2} = 0.2A$

Inductive load
 $I_C = 1A$
 $I_{B1} = 0.2A$
 $V_{BE(off)} = 5V$
 $L = 50mH$ $V_{Clamp} = 300V$

* Pulsed: pulse duration = 300 μs , duty cycle = 2%

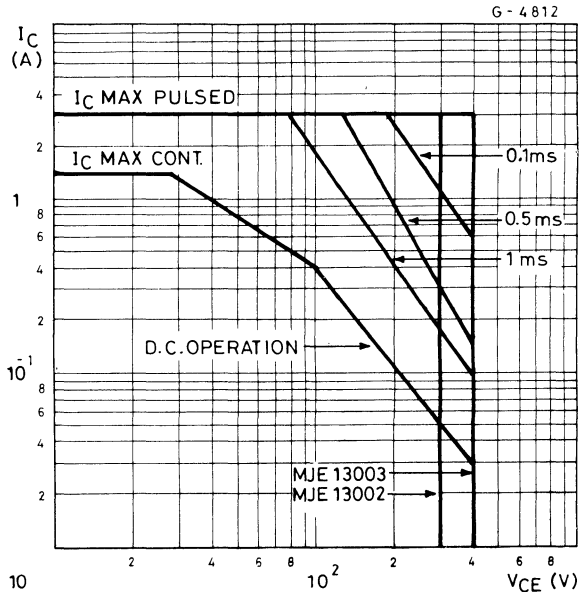
Safe operating areas



MJE13002
MJE13003

DC current gain

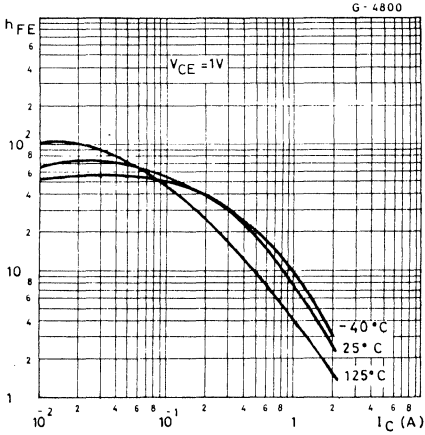

DC current gain

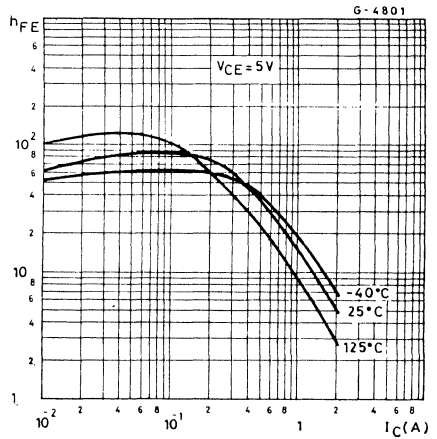

Collector-emitter saturation voltage

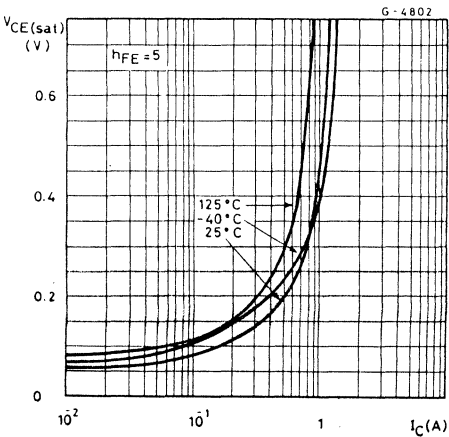

Collector-emitter saturation voltage

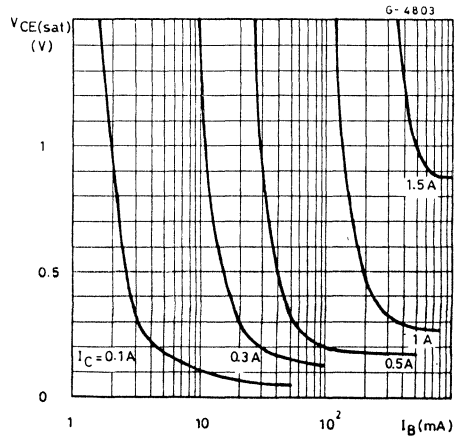

Base-emitter saturation voltage

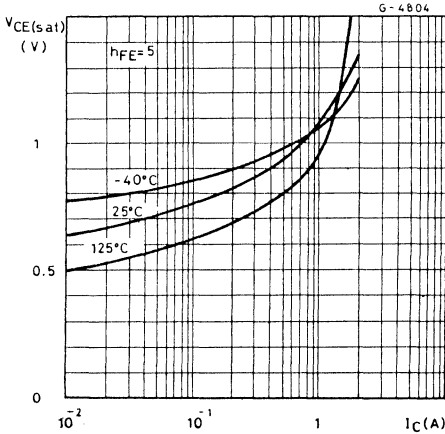

Collector-base capacitance

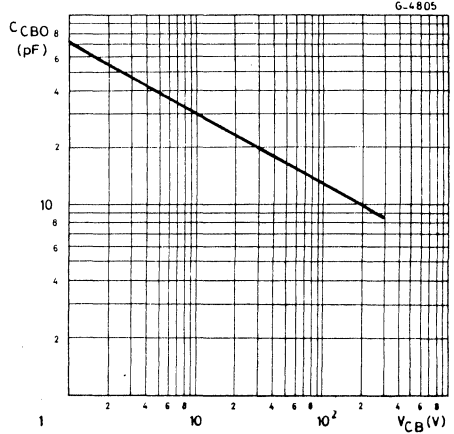

Saturated switching characteristics (inductive load)

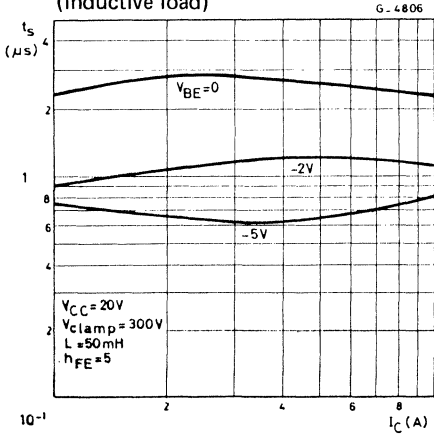

Saturated switching characteristics (inductive load)

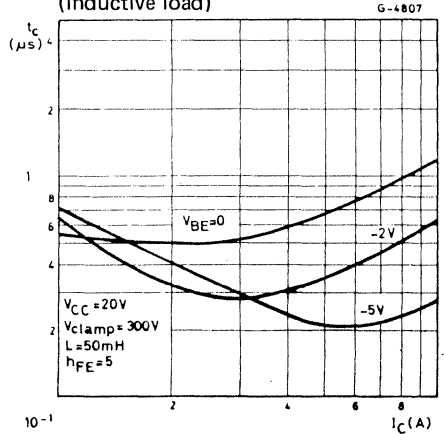

Saturated switching characteristics
(inductive load)

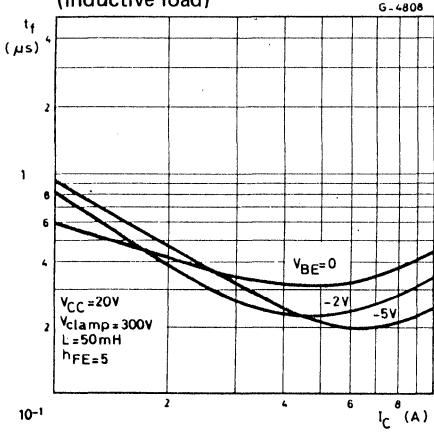

Saturated switching characteristics
(resistive load)

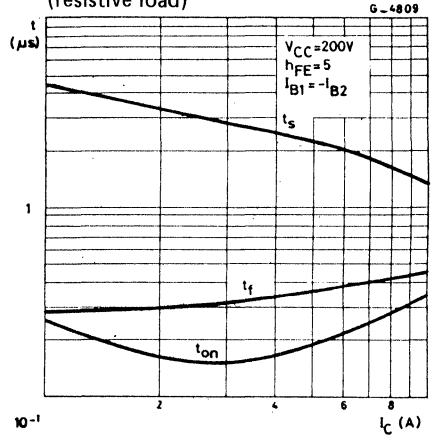

Clamped reverse bias safe operating
areas

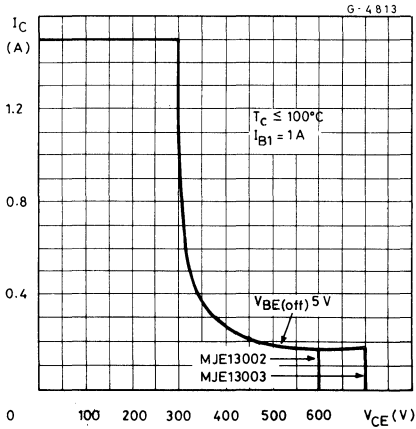

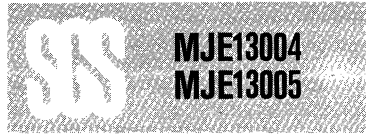

MULTIEPITAXIAL MESA NPN

HIGH VOLTAGE POWER SWITCH

The MJE13004/13005 are silicon multiepitaxial mesa NPN transistors in Jedec TO-220 plastic package particularly intended for switch-mode applications.

ABSOLUTE MAXIMUM RATINGS

		MJE13004	MJE13005
V_{CEV}	Collector-emitter voltage	600V	700V
V_{CEO}	Collector-emitter voltage ($I_B = 0$)	300V	400V
V_{EBO}	Emitter-base ($I_C = 0$)		9V
I_C	Collector current		4A
I_{CM}	Collector peak current		8A
I_B	Base current		2A
I_{BM}	Base peak current		4A
P_{tot}	Total power dissipation at $T_{case} \leq 25^\circ C$		75W
T_{stg}	Storage temperature	-65 to $150^\circ C$	
T_j	Junction temperature	150°C	

INTERNAL SCHEMATIC DIAGRAM

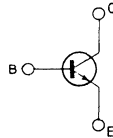

MECHANICAL DATA

Dimensions in mm

Collector connected to tab.

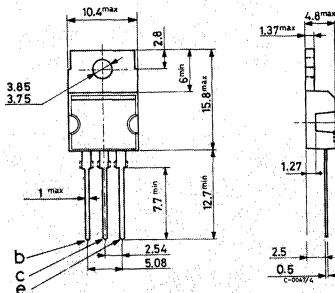

TO-220



MJE13004
MJE13005

THERMAL DATA

$R_{th\ j-case}$ Thermal resistance junction-case	max. 1.67 °C/W
---	----------------

ELECTRICAL CHARACTERISTICS ($T_{case} = 25^{\circ}C$ unless otherwise specified)

Parameter	Test conditions	Min.	Typ.	Max.	Unit
I_{CEV} Collector cutoff current ($V_{BE} = -1.5V$)	for MJE13004 $V_{CE} = 600V$ $V_{CE} = 600V$ $T_{case} = 100^{\circ}C$ for MJE13005 $V_{CE} = 700V$ $V_{CE} = 700V$ $T_{case} = 100^{\circ}C$			1 5 1 5	mA mA mA mA
I_{EBO} Emitter cutoff current ($I_C = 0$)	$V_{EB} = 9V$			1	mA
$V_{CEO(sus)}$ * Collector-emitter sustaining voltage ($I_B = 0$)	$I_C = 10mA$ for MJE13004 for MJE13005	300		400	V V
$V_{CE(sat)}$ * Collector-emitter saturation voltage	$I_C = 1A$ $I_B = 0.2A$ $I_C = 2A$ $I_B = 0.5A$ $I_C = 4A$ $I_B = 1A$			0.5 0.6 1	V V V
$V_{BE(sat)}$ * Base-emitter saturation voltage	$I_C = 1A$ $I_B = 0.2A$ $I_C = 2A$ $I_B = 0.5A$			1.2 1.6	V V
h_{FE} DC current gain	$I_C = 1A$ $V_{CE} = 5V$ $I_C = 2A$ $V_{CE} = 5V$	10 8	30	60 40	— —
t_{on} Turn-on time	$I_C = 2A$ $I_{B1} = -I_{B2} = 0.4A$ $V_{CC} = 250V$			0.8	μs
t_s Storage time				4	μs
t_f Fall time				0.9	μs

* Pulsed: pulse duration = 300 μs , duty cycle = 1.5%.

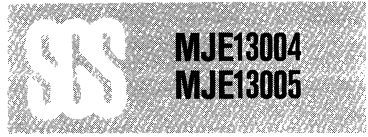

Safe operating areas

I — Area of permissible operation during turn-on provided $R_{BE} \leq 100\Omega$ and $t_p \leq 0.25 \mu s$.

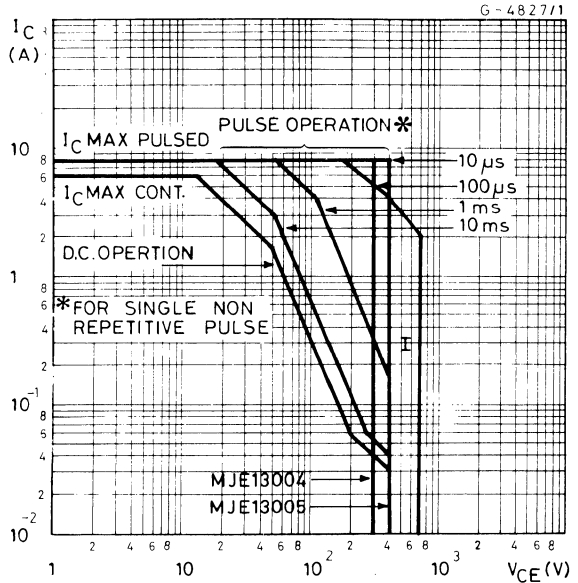

DC current gain

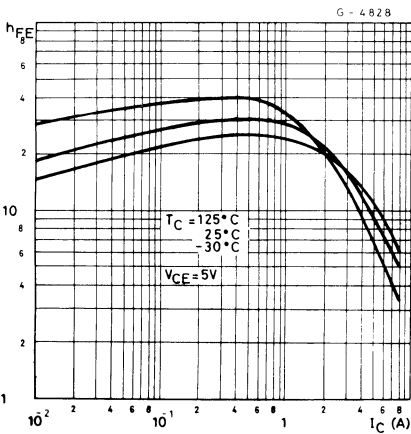

Collector-emitter saturation voltage

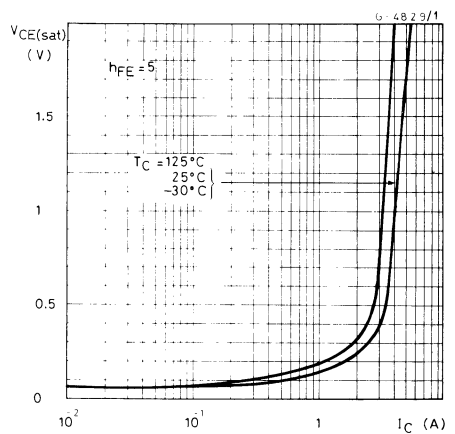

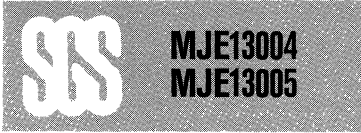

Collector-emitter saturation voltage

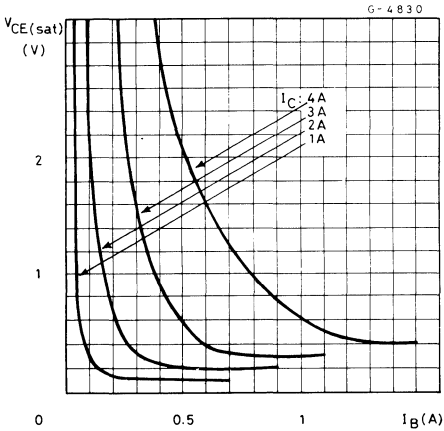

Base-emitter saturation voltage

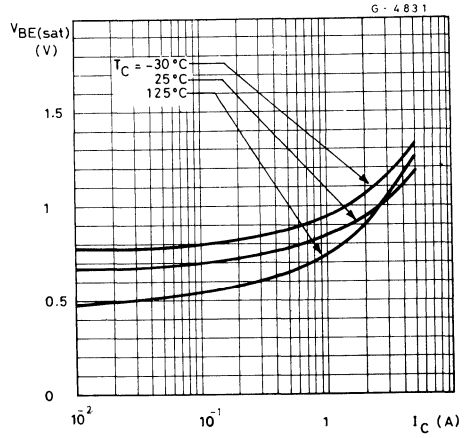

Saturated switching characteristics

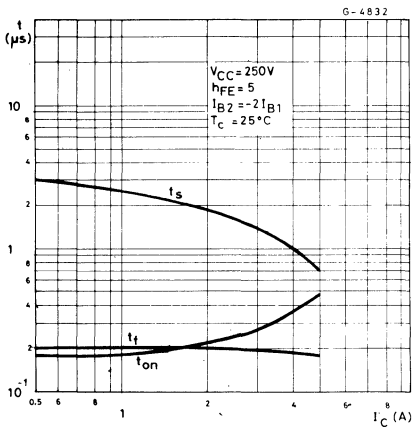

Saturated switching characteristics

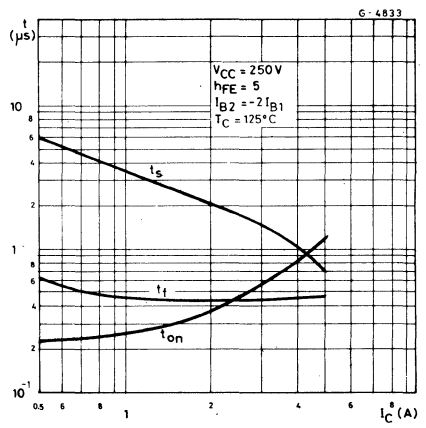

Saturated switching characteristics

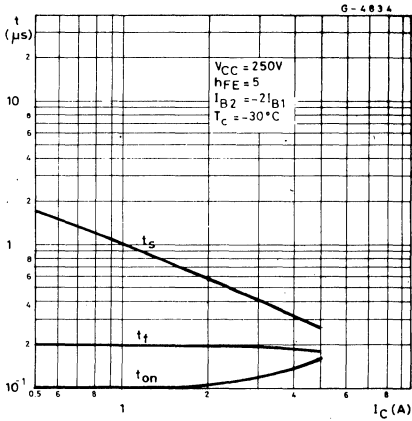

Clamped reverse bias safe operating areas

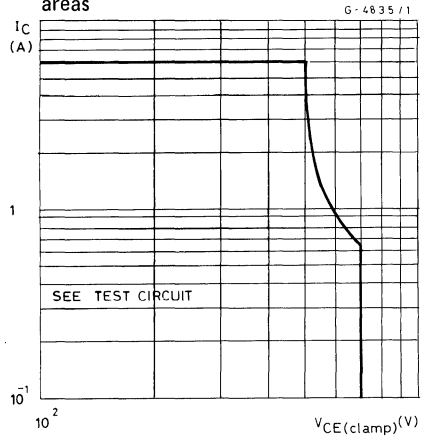

Clamped $E_{s/b}$ test circuit

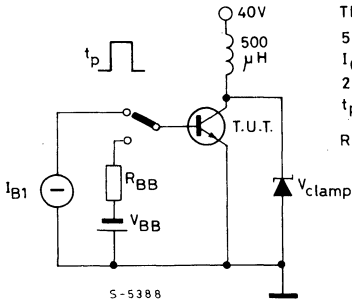

TEST CONDITIONS ;

- $5V \geq |-V_{BB}| \geq 2V$
- $I_C |I_B| \geq 4$
- $2|I_{B1}| \geq |-I_{B2}| \geq I_{B1}$
- $t_p = \text{adjusted for nominal } I_C$
- $R_{BB} = \text{adjusted for } I_{B2}$



MJE13006
MJE13007
MJE13007A

MULTIEPITAXIAL MESA NPN

MOTOR CONTROL, SWITCH REGULATORS

The MJE13006, MJE13007 and MJE13007A are silicon multiepitaxial mesa NPN transistors. They are mounted in Jedec TO-220 plastic package, intended for use in motor controls, switching regulator's etc.

ABSOLUTE MAXIMUM RATINGS

	MJE13006	MJE13007	MJE13007A
V_{CEO}	300V	400V	400V
V_{CEV}	600V	700V	850V
V_{EBO}		9V	
I_C		8A	
I_{CM}		16A	
I_B		4A	
I_{BM}		8A	
I_E		12A	
I_{EM}		24A	
P_{tot}		80W	
T_{stg}		-65 to 150°C	
T_j		150°C	

INTERNAL SCHEMATIC DIAGRAMS

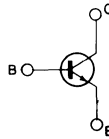

MECHANICAL DATA

Dimensions in mm

Collector connected to tab.

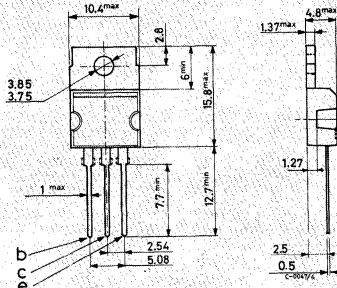

TO-220



THERMAL DATA

$R_{th\ j-case}$	Thermal resistance junction-case	max. 1.56 °C/W
------------------	----------------------------------	----------------

ELECTRICAL CHARACTERISTICS ($T_{case} = 25^{\circ}C$ unless otherwise specified)

Parameter	Test conditions	Min.	Typ.	Max.	Unit
I_{EBO}	Emitter cutoff current ($I_C = 0$)			1	mA
I_{CEV}	Collector cutoff current	$V_{CEV} = \text{Rated value}$ $V_{BE(off)} = 1.5V$ $V_{CEV} = \text{Rated value}$ $V_{BE(off)} = 1.5V$ $T_{case} = 100^{\circ}C$		1	mA
				5	mA
$V_{CEO(sus)}$ *	Collector-emitter sustaining voltage	$I_C = 10mA$ $I_B = 0$ for MJE13006 for MJE13007/13007A	300	400	V V
$V_{CE(sat)}$ *	Collector-emitter saturation voltage	$I_C = 2A$ $I_B = 0.4A$ $I_C = 5A$ $I_B = 1A$ $I_C = 8A$ $I_B = 2A$ $I_C = 5A$ $I_B = 1A$ $T_{case} = 100^{\circ}C$		1	V
				1.5	V
				3	V
				2	V
$V_{BE(sat)}$ *	Base-emitter saturation voltage	$I_C = 2A$ $I_B = 0.4A$ $I_C = 5A$ $I_B = 1A$ $I_C = 5A$ $I_B = 1A$ $T_{case} = 100^{\circ}C$		1.2	V
				1.6	V
				1.5	V
h_{FE} *	DC current gain	$I_C = 2A$ $V_{CE} = 5V$ $I_C = 5A$ $V_{CE} = 5V$	8	40	—
			6	30	—
f_T	Transition frequency	$I_C = 500mA$ $V_{CE} = 10V$ $f = 1MHz$	4		MHz
C_{ob}	Output capacitance	$V_{CB} = 10V$ $I_E = 0$ $f = 0.1MHz$	110		pF
t_{on}	Turn-on time	$V_{CC} = 125V$ $I_C = 5A$ $I_{B1} = I_{B2} = 1A$ $t_p = 25\mu s$ Duty Cycle $\leq 1\%$		1.1	μs
t_s	Storage time			3	μs
t_f	Fall time			0.7	μs

* Pulsed: pulse duration = 300 μs , duty cycle = 1.5%.

MEDIUM POWER LINEAR AND SWITCHING APPLICATIONS

The TIP 29, TIP 29A, TIP 29B and TIP 29C are silicon epitaxial-base NPN power transistors in Jedec TO-220 plastic package, intended for use in medium power linear and switching applications.

The complementary PNP types are the TIP 30, TIP 30A, TIP 30B and TIP 30C.

ABSOLUTE MAXIMUM RATINGS

		TIP 29	TIP 29A	TIP 29B	TIP 29C
V_{CB0}	Collector-base voltage ($I_E = 0$)	40V	60V	80V	100V
V_{CEO}	Collector-emitter voltage ($I_B = 0$)	40V	60V	80V	100V
V_{EBO}	Emitter-base voltage ($I_C = 0$)			5V	
I_C	Collector current			1A	
I_{CM}	Collector peak current			3A	
I_B	Base current			0.4A	
P_{tot}	Total power dissipation at $T_{case} \leq 25^\circ\text{C}$ $T_{amb} \leq 25^\circ\text{C}$			30W	
T_{stg}	Storage temperature			2W	
T_j	Junction temperature			-65 to 150°C	150°C

INTERNAL SCHEMATIC DIAGRAM

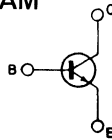

MECHANICAL DATA

Dimensions in mm

Collector connected to tab.

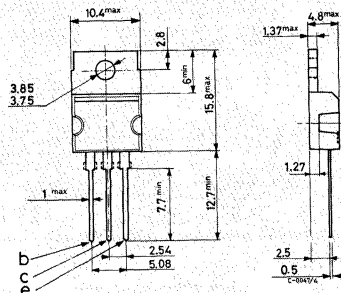

TO-220



THERMAL DATA

$R_{th\ j-case}$	Thermal resistance junction-case	max	4.17	°C/W
$R_{th\ j-amb}$	Thermal resistance junction-ambient	max	62.5	°C/W

ELECTRICAL CHARACTERISTICS ($T_{case} = 25^{\circ}C$ unless otherwise specified)

Parameter	Test conditions	Min.	Typ.	Max.	Unit
I_{CEO} Collector cutoff current ($I_B = 0$)	for TIP 29 and TIP 29A $V_{CE} = 30V$		0.3		mA
	for TIP 29B and TIP 29C $V_{CE} = 60V$		0.3		mA
I_{CES} Collector cutoff current ($V_{BE} = 0$)	for TIP 29 $V_{CE} = 40V$		0.2		mA
	for TIP 29A $V_{CE} = 60V$		0.2		mA
	for TIP 29B $V_{CE} = 80V$		0.2		mA
	for TIP 29C $V_{CE} = 100V$		0.2		mA
I_{EBO} Emitter cutoff current ($I_C = 0$)	$V_{EB} = 5V$		1		mA
$V_{CE0(sus)}$ * Collector-emitter sustaining voltage ($I_B = 0$)	$I_C = 30mA$ for TIP 29 for TIP 29A for TIP 29B for TIP 29C	40		100	V
$V_{CE(sat)}$ * Collector-emitter saturation voltage	$I_C = 1A$ $I_B = 125mA$		0.7		V
$V_{BE(on)}$ * Base-emitter voltage	$I_C = 1A$ $V_{CE} = 4V$		1.3		V
h_{FE} * DC current gain	$I_C = 0.2A$ $V_{CE} = 4V$	40			—
	$I_C = 1A$ $V_{CE} = 4V$	15	75		—
h_{fe} Small signal current gain	$I_C = 0.2A$ $V_{CE} = 10V$ $f = 1KHz$	20			—
	$I_C = 0.2A$ $V_{CE} = 10V$ $f = 1MHz$	3			—

* Pulsed: pulse duration = 300 μ s, duty cycle \leq 2%.

MEDIUM POWER LINEAR AND SWITCHING APPLICATIONS

The TIP 30, TIP 30A, TIP 30B and TIP 30C are silicon epitaxial-base PNP power transistors in Jedec TO-220 plastic package, intended for use in medium power linear and switching applications.

The complementary NPN types are the TIP 29, TIP 29A, TIP 29B and TIP 29C respectively.

ABSOLUTE MAXIMUM RATINGS

		TIP 30	TIP 30A	TIP 30B	TIP 30C
V_{CBO}	Collector-base voltage ($I_E = 0$)	-40V	-60V	-80V	-100V
V_{CEO}	Collector-emitter voltage ($I_B = 0$)	-40V	-60V	-80V	-100V
V_{EBO}	Emitter-base voltage ($I_C = 0$)			-5V	
I_C	Collector current			-1A	
I_{CM}	Collector peak current			-3A	
I_B	Base current			-0.4A	
P_{tot}	Total power dissipation at $T_{case} \leq 25^\circ C$ $T_{amb} \leq 25^\circ C$			30W	
T_{stg}	Storage temperature			2W	
T_j	Junction temperature			-65 to 150°C	150°C

INTERNAL SCHEMATIC DIAGRAM

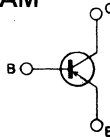

MECHANICAL DATA

Dimensions in mm

Collector connected to tab.

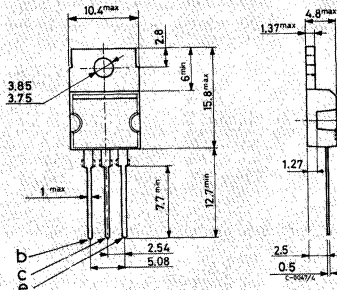

TO-220

THERMAL DATA

$R_{th\ j-case}$	Thermal resistance junction-case	max	4.17	°C/W
$R_{th\ j-amb}$	Thermal resistance junction-ambient	max	62.5	°C/W

ELECTRICAL CHARACTERISTICS ($T_{case} = 25^{\circ}C$ unless otherwise specified)

Parameter	Test conditions	Min.	Typ.	Max.	Unit
I_{CEO}	Collector-cutoff current ($I_B = 0$)	for TIP 30 and TIP 30A $V_{CE} = -30V$		-0.3	mA
		for TIP 30B and TIP 30C $V_{CE} = -60V$		-0.3	mA
I_{CES}	Collector cutoff current ($V_{BE} = 0$)	for TIP 30	$V_{CE} = -40V$	-0.2	mA
		for TIP 30A	$V_{CE} = -60V$	-0.2	mA
		for TIP 30B	$V_{CE} = -80V$	-0.2	mA
		for TIP 30C	$V_{CE} = -100V$	-0.2	mA
I_{EBO}	Emitter cutoff current ($I_C = 0$)	$V_{EB} = -5V$		-1	mA
$V_{CEO(sus)}$	*Collector-emitter sustaining voltage ($I_B = 0$)	$I_C = -30mA$		-40	V
		for TIP 30		-60	V
		for TIP 30A		-80	V
		for TIP 30B		-100	V
		for TIP 30C			
$V_{CE(sat)}$	* Collector-emitter saturation voltage	$I_C = -1A$;	$I_B = -125mA$	-0.7	V
$V_{BE(on)}$	* Base-emitter voltage	$I_C = -1A$	$V_{CE} = -4V$	-1.3	V
h_{FE}	* DC current gain	$I_C = -0.2A$	$V_{CE} = -4V$	40	—
		$I_C = -1A$	$V_{CE} = -4V$	15	—
				75	—
h_{fe}	Small signal current gain	$I_C = -0.2A$	$V_{CE} = -10V$	20	—
		$f = 1KHz$			
		$I_C = -0.2A$	$V_{CE} = -10V$	3	—
		$f = 1MHz$			

* Pulsed: pulse duration = 300 μs , duty cycle $\leq 2\%$.

MEDIUM POWER LINEAR AND SWITCHING APPLICATIONS

The TIP 31, TIP 31A, TIP 31B and TIP 31C are silicon epitaxial-base NPN power transistors in Jedec TO-220 plastic package, intended for use in medium power linear and switching applications.

The complementary PNP types are the TIP 32, TIP 32A, TIP 32B and TIP 32C.

ABSOLUTE MAXIMUM RATINGS

		TIP 31	TIP 31A	TIP 31B	TIP 31C
V_{CBO}	Collector-base voltage ($I_E = 0$)	40V	60V	80V	100V
V_{CEO}	Collector-emitter voltage ($I_B = 0$)	40V	60V	80V	100V
V_{EBO}	Emitter-base voltage ($I_C = 0$)		5V		
I_C	Collector current		3A		
I_{CM}	Collector peak current		5A		
I_B	Base-current		1A		
P_{tot}	Total power dissipation at $T_{case} \leq 25^\circ C$ $T_{amb} \leq 25^\circ C$		40W		
T_{stg}	Storage temperature		-65 to 150°C		
T_j	Junction temperature		150°C		

INTERNAL SCHEMATIC DIAGRAM

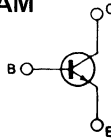

MECHANICAL DATA

Dimensions in mm

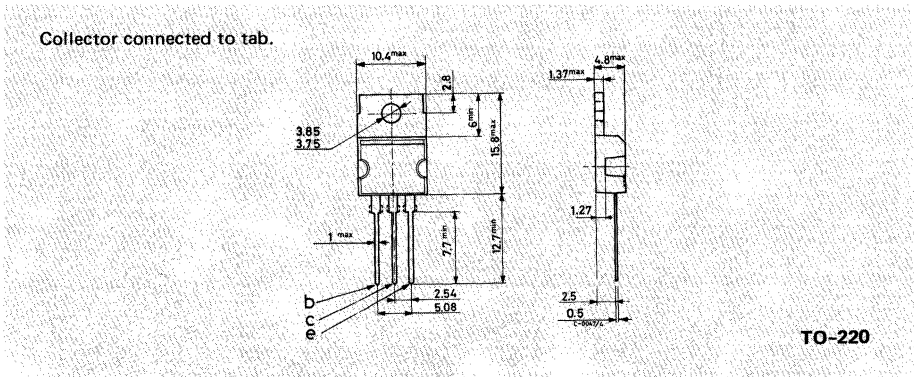



THERMAL DATA

$R_{th\ j-case}$	Thermal resistance junction-case	max	3.12	°C/W
$R_{th\ j-amb}$	Thermal resistance junction-ambient	max	62.5	°C/W

ELECTRICAL CHARACTERISTICS ($T_{case} = 25^{\circ}C$ unless otherwise specified)

Parameter	Test conditions	Min.	Typ.	Max.	Unit
I_{CEO}	Collector cutoff current ($I_B = 0$) for TIP 31 and TIP 31A $V_{CE} = 30V$ for TIP 31B and TIP 31C $V_{CE} = 60V$			0.3	mA
I_{CES}	Collector cutoff current ($V_{BE} = 0$) for TIP 31 $V_{CE} = 40V$ for TIP 31A $V_{CE} = 60V$ for TIP 31B $V_{CE} = 80V$ for TIP 31C $V_{CE} = 100V$			0.2	mA
I_{EBO}	Emitter cutoff current ($I_C = 0$) $V_{EB} = 5V$			1	mA
$V_{CEO(sus)}$ * Collector-emitter sustaining voltage ($I_B = 0$)	$I_C = 30mA$ for TIP 31 for TIP 31A for TIP 31B for TIP 31C	40			V
$V_{CE(sat)}$ * Collector-emitter saturation voltage	$I_C = 3A$ $I_B = 375mA$			1.2	V
$V_{BE(on)}$ * Base-emitter voltage	$I_C = 3A$ $V_{CE} = 4V$			1.8	V
h_{FE} * DC current gain	$I_C = 1A$ $V_{CE} = 4V$ $I_C = 3A$ $V_{CE} = 4V$	25		50	—
h_{fe} Small signal current gain	$I_C = 0.5A$ $V_{CE} = 10V$ $f = 1KHz$ $I_C = 0.5A$ $V_{CE} = 10V$ $f = 1MHz$	20			—
		3			—

* Pulsed: pulse duration = $300\mu s$, duty cycle $\leq 2\%$.

MEDIUM POWER LINEAR AND SWITCHING APPLICATIONS

The TIP 32, TIP 32A, TIP 32B and TIP 32C are silicon epitaxial-base PNP power transistors in Jedec TO-220 plastic package, intended for use in medium power linear and switching applications.

The complementary NPN types are the TIP 31, TIP 31A, TIP 31B and TIP 31C.

ABSOLUTE MAXIMUM RATINGS

		TIP 32	TIP 32A	TIP 32B	TIP 32C
V_{CBO}	Collector-base voltage ($I_C = 0$)	-40V	-60V	-80V	-100V
V_{CEO}	Collector-emitter voltage ($I_B = 0$)	-40V	-60V	-80V	-100V
V_{EBO}	Emitter-base voltage ($I_C = 0$)		-5V		
I_C	Collector current		-3A		
I_{CM}	Collector peak current		-5A		
I_B	Base-current		-1A		
P_{tot}	Total power dissipation at $T_{case} \leq 25^\circ C$ $T_{amb} \leq 25^\circ C$		40W		
T_{stg}	Storage temperature		2W		
T_j	Junction temperature		-65 to 150°C		150°C

INTERNAL SCHEMATIC DIAGRAM

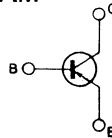

MECHANICAL DATA

Dimensions in mm

Collector connected to tab.

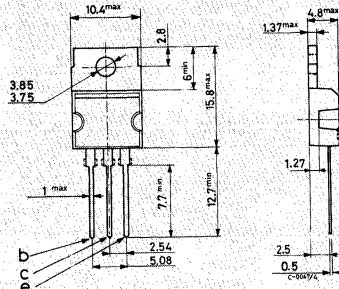

TO-220



THERMAL DATA

$R_{th\ j-case}$	Thermal resistance junction-case	max	3.12	°C/W
$R_{th\ j-amb}$	Thermal resistance junction-ambient	max	62.5	°C/W

ELECTRICAL CHARACTERISTICS ($T_{case} = 25^{\circ}C$ unless otherwise specified)

Parameter		Test conditions		Min.	Typ.	Max.	Unit
I_{CEO}	Collector cutoff current ($I_B = 0$)	for TIP 32 and TIP 32A				-0.3	mA
		$V_{CE} = -30V$					
I_{CES}	Collector cutoff current ($V_{BE} = 0$)	for TIP 32B and TIP 32C				-0.3	mA
		$V_{CE} = -60V$					
I_{CES}	Collector cutoff current ($V_{BE} = 0$)	for TIP 32	$V_{CE} = -40V$			-0.2	mA
		for TIP 32A	$V_{CE} = -60V$			-0.2	mA
		for TIP 32B	$V_{CE} = -80V$			-0.2	mA
		for TIP 32C	$V_{CE} = -100V$			-0.2	mA
I_{EBO}	Emitter cutoff current ($I_C = 0$)	$V_{EB} = -5V$				-1	mA
$V_{CEO(sus)}$	*Collector-emitter sustaining voltage ($I_B = 0$)	$I_C = -30mA$				-40	V
		for TIP 32				-60	V
		for TIP 32A				-80	V
		for TIP 32B				-100	V
$V_{CE(sat)}$	* Collector-emitter saturation voltage	$I_C = -3A$	$I_B = -375mA$			-1.2	V
$V_{BE(on)}$	* Base-emitter voltage	$I_C = -3A$	$V_{CE} = -4V$			-1.8	V
h_{FE}	DC current gain	$I_C = -1A$	$V_{CE} = -4V$	25			—
		$I_C = -3A$	$V_{CE} = -4V$	10	50		—
h_{fe}	Small signal current gain	$I_C = -0.5A$	$V_{CE} = -10V$	20			—
		$f = 1KHz$					
		$I_C = -0.5A$	$V_{CE} = -10V$	3			—
		$f = 1MHz$					

* Pulsed: pulse duration = 300 μ s, duty cycle \leq 2%.



TIP41
TIP41A
TIP41B
TIP41C

EPITAXIAL-BASE NPN

MEDIUM POWER LINEAR AND SWITCHING APPLICATIONS

The TIP 41, TIP 41A, TIP 41B, and TIP 41C are silicon epitaxial-base NPN power transistors in Jedec TO-220 plastic package intended for use in medium power linear and switching applications.

The complementary PNP types are the TIP 42, TIP 42A, TIP 42B and TIP 42C respectively.

ABSOLUTE MAXIMUM RATINGS

	TIP41	TIP41A	TIP41B	TIP41C
V_{CBO}	40V	60V	80V	100V
V_{CEO}	40V	60V	80V	100V
V_{EBO}			5V	
I_C			6A	
I_{CM}			10A	
I_B			3A	
P_{tot}			65W	
			2W	
T_{stg}			-65 to 150°C	
T_j			150°C	

INTERNAL SCHEMATIC DIAGRAM

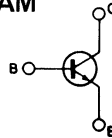

MECHANICAL DATA

Dimensions in mm

Collector connected to tab.

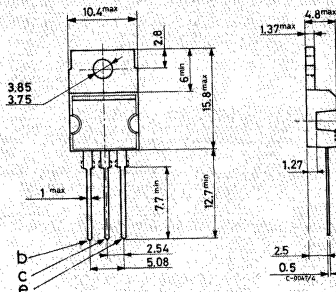

TO-220



THERMAL DATA

$R_{th\ j-case}$	Thermal resistance junction-case	max	1.92	°C/W
$R_{th\ j-amb}$	Thermal resistance junction-ambient	max	62.5	°C/W

ELECTRICAL CHARACTERISTICS ($T_{case} = 25^{\circ}C$ unless otherwise specified)

Parameter	Test conditions	Min.	Typ.	Max.	Unit
I_{CEO}	Collector cutoff current ($I_B = 0$)	for TIP41 and TIP41A $V_{CE} = 30V$		0.7	mA
		for TIP41B and TIP41C $V_{CE} = 60V$		0.7	mA
I_{CES}	Collector cutoff current ($V_{BE} = 0$)	for TIP41	$V_{CE} = 40V$	0.4	mA
		for TIP41A	$V_{CE} = 60V$	0.4	mA
		for TIP41B	$V_{CE} = 80V$	0.4	mA
		for TIP41C	$V_{CE} = 100V$	0.4	mA
I_{EBO}	Emitter cutoff current ($I_C = 0$)	$V_{EB} = 5V$		1	mA
$V_{CEO(sus)}$	* Collector-emitter sustaining voltage ($I_B = 0$)	$I_C = 30mA$ for TIP41 for TIP41A for TIP41B for TIP41C		40 60 80 100	V V V V
$V_{CE(sat)}$	* Collector-emitter saturation voltage	$I_C = 6A$	$I_B = 0.6A$	1.5	V
V_{BE}	* Base-emitter voltage	$I_C = 6A$	$V_{CE} = 4V$	2	V
h_{FE}	* DC current gain	$I_C = 0.3A$ $I_C = 3A$	$V_{CE} = 4V$ $V_{CE} = 4V$	30 15	— —
h_{fe}	Small signal current gain	$I_C = 0.5A$ $f = 1KHz$ $f = 1MHz$	$V_{CE} = 10V$	20 3	— —

* Pulsed: pulse duration = 300 μs , duty cycle $\leq 2\%$



EPITAXIAL-BASE PNP

MEDIUM POWER LINEAR AND SWITCHING APPLICATIONS

The TIP 42, TIP 42A, TIP 42B and TIP 42C are silicon epitaxial-base PNP power transistors in Jedec TO-220 plastic package, intended for use in medium power linear and switching applications.

The complementary NPN types are the TIP 41, TIP 41A, TIP 41B and TIP 41C respectively.

ABSOLUTE MAXIMUM RATINGS

	TIP 42	TIP 42A	TIP 42B	TIP 42C	
V_{CBO}	Collector-base voltage ($I_E = 0$)	-40V	-60V	-80V	-100V
V_{CEO}	Collector-emitter voltage ($I_B = 0$)	-40V	-60V	-80V	-100V
V_{EBO}	Emitter-base voltage ($I_C = 0$)		-5V		
I_C	Collector current		-6A		
I_{CM}	Collector peak current		-10A		
I_B	Base current		-3A		
P_{tot}	Total power dissipation at $T_{case} \leq 25^\circ C$ $T_{amb} \leq 25^\circ C$		65W		
T_{stg}	Storage temperature		-65 to 150°C		
T_j	Junction temperature		150°C		

INTERNAL SCHEMATIC DIAGRAM

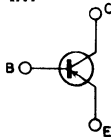

MECHANICAL DATA

Dimensions in mm

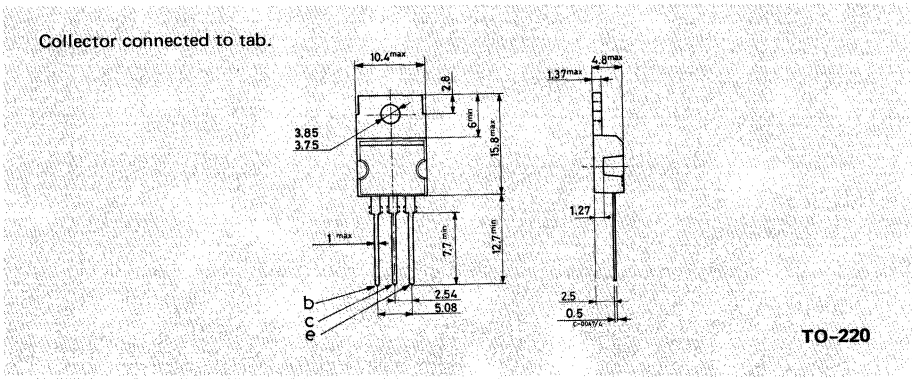

TO-220



THERMAL DATA

$R_{th\ j-case}$	Thermal resistance junction-case	max	1.92	°C/W
$R_{th\ j-amb}$	Thermal resistance junction-ambient	max	62.5	°C/W

ELECTRICAL CHARACTERISTICS ($T_{case} = 25^{\circ}C$ unless otherwise specified)

Parameter		Test conditions		Min.	Typ.	Max.	Unit
I_{CEO}	Collector cutoff current ($I_B = 0$)	for TIP 42 and TIP 42A				-0.7	mA
		$V_{CE} = -30V$					
I_{CES}	Collector cutoff current ($V_{BE} = 0$)	for TIP 42B and TIP 42C				-0.7	mA
		$V_{CE} = -60V$					
I_{CES}	Collector cutoff current ($V_{BE} = 0$)	for TIP 42	$V_{CE} = -40V$			-0.4	mA
		for TIP 42A	$V_{CE} = -60V$			-0.4	mA
		for TIP 42B	$V_{CE} = -80V$			-0.4	mA
		for TIP 42C	$V_{CE} = -100V$			-0.4	mA
I_{EBO}	Emitter cutoff current ($I_C = 0$)	$V_{EB} = -5V$				-1	mA
$V_{CEO(sus)}$ *	Collector-emitter sustaining voltage ($I_B = 0$)	for TIP 42				-40	V
		for TIP 42A				-60	V
		for TIP 42B				-80	V
		for TIP 42C				-100	V
$V_{CE(sat)}$ *	Collector-emitter saturation voltage	$I_C = -6A$	$I_B = -0.6A$			-1.5	V
$V_{BE(on)}$ *	Base-emitter voltage	$I_C = -6A$	$V_{CE} = -4V$			-2	V
h_{FE} *	DC current gain	$I_C = -0.3A$	$V_{CE} = -4V$	30			—
		$I_C = -3A$	$V_{CE} = -4V$	15	75		—
h_{fe}	Small signal current gain	$I_C = -0.5A$	$V_{CE} = -10V$	20			—
		$f = 1KHz$					
		$I_C = -0.5A$	$V_{CE} = -10V$	3			—
		$f = 1MHz$					

* Pulsed: pulse duration = 300 μ s, duty cycle \leq 2%.



TIP47
TIP48
TIP49
TIP50

MULTIEPITAXIAL PLANAR NPN

LINEAR AND SWITCHING APPLICATIONS

The TIP47 to TIP50 are silicon multiepitaxial planar transistors in TO-220 plastic package intended for linear and switching applications.

ABSOLUTE MAXIMUM RATINGS

		TIP47	TIP48	TIP49	TIP50
V_{CBO}	Collector base voltage ($I_E = 0$)	350V	400V	450V	500V
V_{CEO}	Collector emitter voltage ($I_B = 0$)	250V	300V	350V	400V
V_{EBO}	Emitter base voltage ($I_C = 0$)		5V		
I_C	Collector current		1A		
I_{CM}	Collector peak current		2A		
I_B	Base current		0.6A		
P_{tot}	Total power dissipation at $T_{case} \leq 25^\circ C$		40W		
P_{tot}	Total power dissipation at $T_{amb} \leq 25^\circ C$		2W		
T_{stg}	Storage temperature		-65 to 150°C		
T_j	Junction temperature		150°C		

INTERNAL SCHEMATIC DIAGRAM

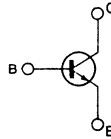

MECHANICAL DATA

Dimensions in mm

Collector connected to tab.

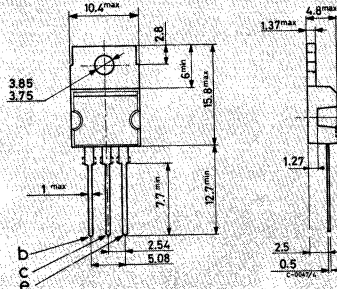

TO-220



THERMAL DATA

$R_{th\ j-case}$	Thermal resistance junction-case	max. 3.125 °C/W
$R_{th\ j-amb}$	Thermal resistance junction-ambient	max. 62.5 °C/W

ELECTRICAL CHARACTERISTICS ($T_{case} = 25^{\circ}C$ unless otherwise specified)

Parameter	Test conditions	Min.	Typ.	Max.	Unit
I_{CES} Collector cutoff current ($V_{BE} = 0$)	for TIP47 $V_{CE} = 350V$ for TIP48 $V_{CE} = 400V$ for TIP49 $V_{CE} = 450V$ for TIP50 $V_{CE} = 500V$			1	mA
I_{CEO} Collector cutoff current ($I_B = 0$)	for TIP47 $V_{CE} = 150V$ for TIP48 $V_{CE} = 200V$ for TIP49 $V_{CE} = 250V$ for TIP50 $V_{CE} = 300V$			1	mA
I_{EBO} Emitter cutoff current ($I_C = 0$)	$V_{EB} = 5V$			1	mA
$V_{CEO(sus)}$ * Collector emitter sustaining voltage	$I_C = 30mA$ for TIP47 for TIP48 for TIP49 for TIP50	250			V
$V_{CE(sat)}$ * Collector emitter saturation voltage	$I_C = 1A$ $I_B = 0.2A$			1	V
$V_{BE(on)}$ * Base emitter on voltage	$I_C = 1A$ $V_{CE} = 10V$			1.5	V

ELECTRICAL CHARACTERISTICS (continued)

Parameter	Test conditions	Min.	Typ.	Max.	Unit
h_{FE}^* DC current gain	$I_C = 0.3A$ $V_{CE} = 10V$ $I_C = 1A$ $V_{CE} = 10V$	30 10		150	—
f_T Transition frequency	$V_{CE} = 10V$ $I_C = 0.2A$ $f = 2MHz$	10			MHz
h_{fe} Small signal current gain	$V_{CE} = 10V$ $I_C = 0.2$ $f = 1KHz$	25			—

* Pulsed: pulse duration = 300 μs duty cycle $\leq 2\%$.

Safe operating areas

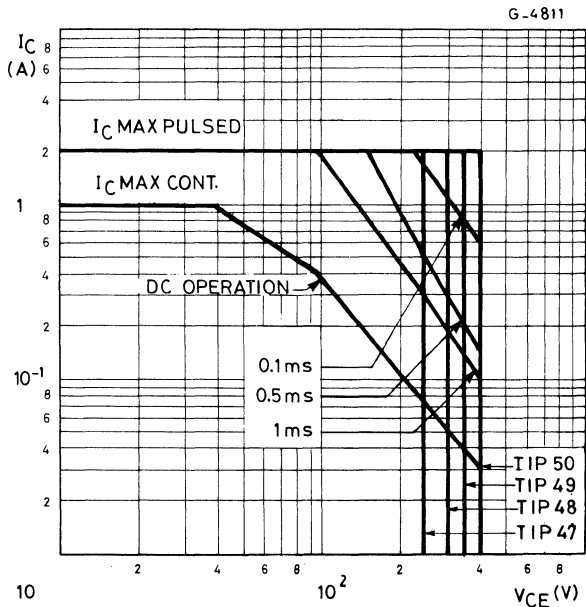

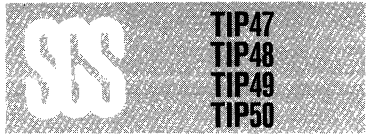

DC current gain

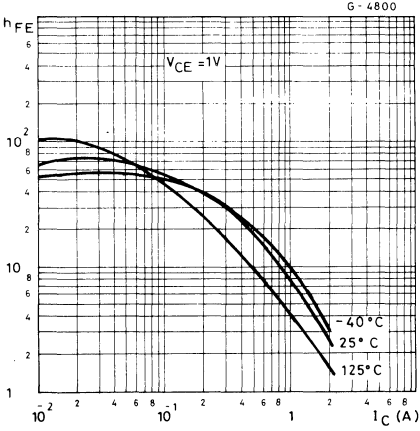

DC current gain

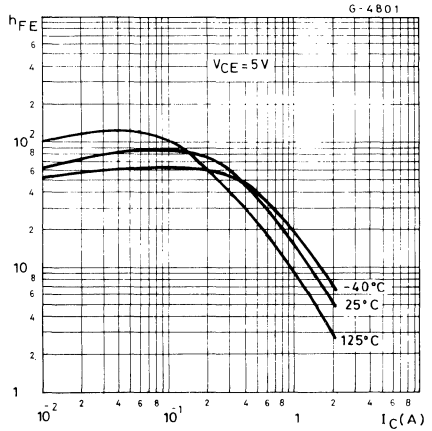

Collector-emitter saturation voltage

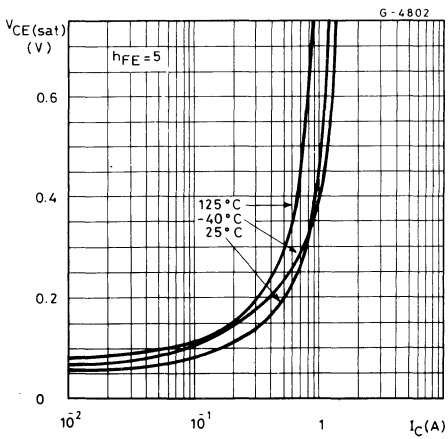

Collector-emitter saturation voltage

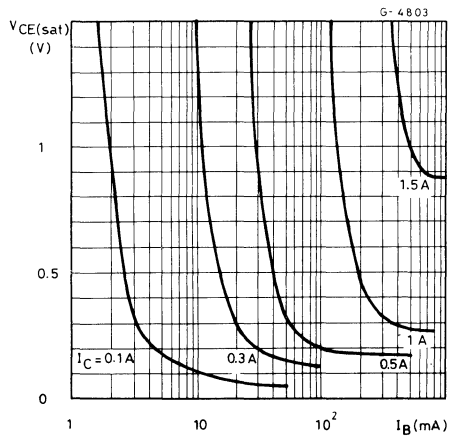

Base-emitter saturation voltage

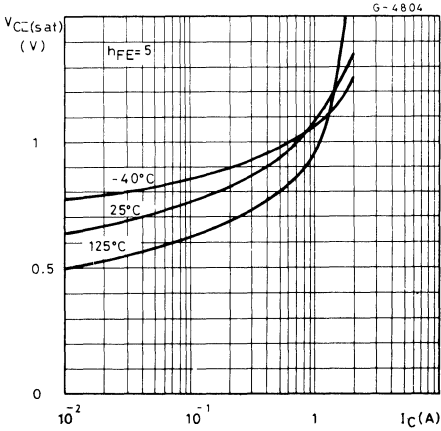

Collector-base capacitance

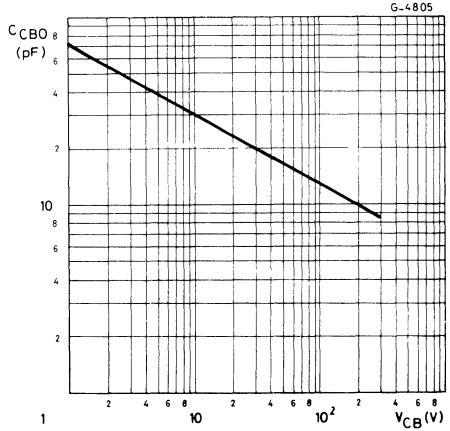

Saturated switching characteristics (inductive load)

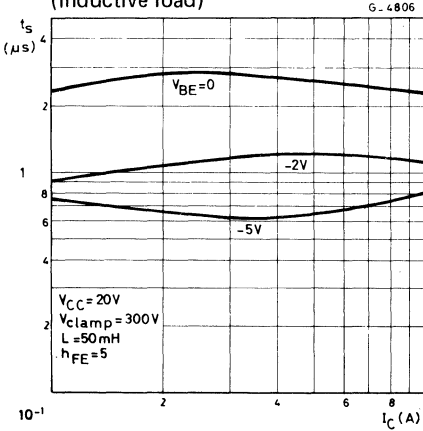

Saturated switching characteristics (inductive load)

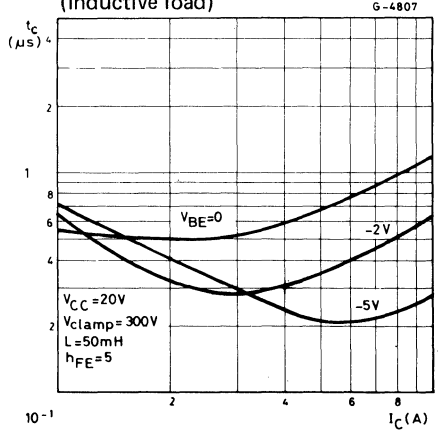

Saturated switching characteristics (inductive load) G-4808

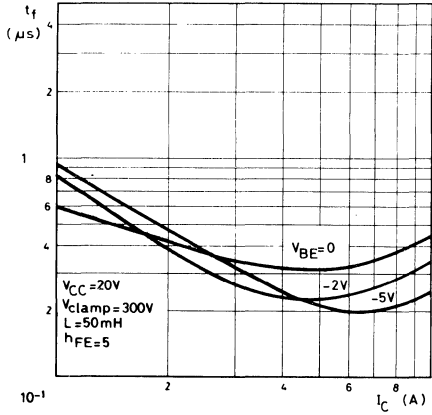

Saturated switching characteristics (resistive load) G-4809

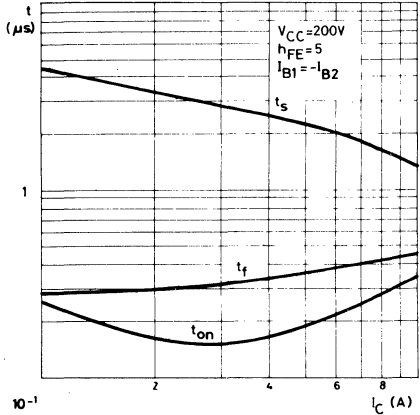

Clamped reverse bias safe operating areas

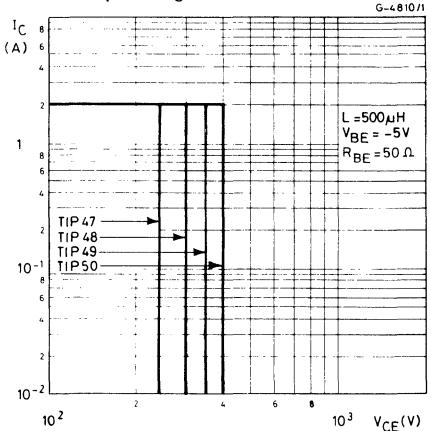



TIP51
TIP52
TIP53
TIP54

MULTIEPITAXIAL MESA NPN

HIGH VOLTAGE POWER SWITCH

The TIP51, TIP52, TIP53, TIP54 are silicon multiepitaxial mesa NPN transistors in SOT-93 plastic package.

They are intended for high voltage, fast switching industrial and consumer applications.

ABSOLUTE MAXIMUM RATINGS

		TIP51	TIP52	TIP53	TIP54
V_{CES}	Collector-emitter voltage ($V_{BE} = 0$)	350V	400V	450V	500V
V_{CEO}	Collector-emitter voltage ($I_B = 0$)	250V	300V	350V	400V
V_{EBO}	Emitter-base voltage ($I_C = 0$)			5V	
I_C	Collector current			3V	
I_{CM}	Collector peak current			5A	
I_B	Base current			0.6A	
P_{tot}	Total power dissipation at $T_{case} \leq 25^\circ C$			100W	
T_{stg}	Storage temperature			-65 to 150°C	
T_j	Junction temperature			150°C	

INTERNAL SCHEMATIC DIAGRAM

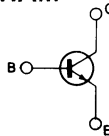

MECHANICAL DATA

Dimensions in mm

Collector connected to tab.

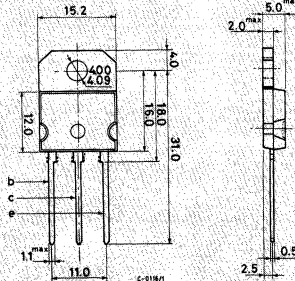

(sim. to TO-218) SOT-93



THERMAL DATA

$R_{th\ j-case}$	Thermal resistance junction-case	max. 1.25 °C/W
------------------	----------------------------------	----------------

ELECTRICAL CHARACTERISTICS ($T_{case} = 25^{\circ}C$ unless otherwise specified)

Parameter		Test conditions		Min.	Typ.	Max.	Unit
I_{CES}	Collector-cutoff current ($V_{BE} = 0$)	for TIP51 for TIP52 for TIP53 for TIP54	$V_{CE} = 350V$ $V_{CE} = 400V$ $V_{CE} = 450V$ $V_{CE} = 500V$			1 1 1 1	mA mA mA mA
I_{CEO}	Collector cutoff current ($I_B = 0$)	for TIP51 for TIP52 for TIP53 for TIP54	$V_{CE} = 150V$ $V_{CE} = 200V$ $V_{CE} = 250V$ $V_{CE} = 300V$			1 1 1 1	mA mA mA mA
I_{EBO}	Emitter cutoff current ($I_C = 0$)	$V_{EB} = 5V$				1	mA
$V_{CEO(sus)}^*$	Collector-emitter sustaining voltage ($I_B = 0$)	$I_C = 30mA$	for TIP51 for TIP52 for TIP53 for TIP54	250 300 350 400			V V V V
$V_{CE(sat)}^*$	Collector-emitter saturation voltage	$I_C = 3A$	$I_B = 0.6A$			1.5	V
V_{BE}^*	Base-emitter	$I_C = 3A$	$V_{CE} = 10V$			1.5	V
h_{FE}^*	DC current gain	$I_C = 0.3A$ $I_C = 3A$	$V_{CE} = 10V$ $V_{CE} = 10V$	30 10	150		—
h_{fe}	Small signal current gain	$I_C = 0.2A; V_{CE} = 10V; f = 1KHz$ $I_C = 0.2A; V_{CE} = 10V; f = 1MHz$		30 2.5			— —



ELECTRICAL CHARACTERISTICS (continued)

Parameter	Test conditions	Min. Typ. Max.	Unit	
$E_{s/b}$	Second breakdown Un clamped energy	$V_{BE} = 20V$ $R_{BE} = 100\Omega$ $L = 30mH$	100	mJ
t_{on}	Turn-on time	$I_C = 1A$ $I_{B1} = 100mA$ $V_{CC} = 200V$	0.2	μs
t_{off}	Turn-off time	$I_C = 1A$ $I_{B1} = -I_{B2} = 100mA$ $V_{CC} = 200V$	2	μs

* Pulsed: pulse duration = 300 μs , duty cycle = 1.5%

Safe operating areas

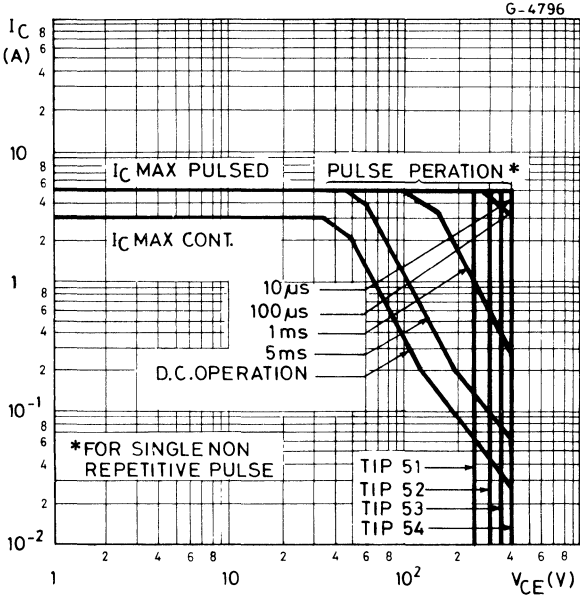

EPITAXIAL-BASE NPN



POWER DARLINGTONS

The TIP 100, TIP 101 and TIP 102 are silicon epitaxial-base NPN transistors in monolithic Darlington configuration mounted in Jedec TO-220 plastic package, intended for use in power linear and switching applications. The complementary PNP types are the TIP 105, TIP 106 and TIP 107 respectively.

ABSOLUTE MAXIMUM RATINGS

	TIP 100	TIP 101	TIP 102
V_{CB0}	60V	80V	100V
V_{CE0}	60V	80V	100V
V_{EBO}		5V	
I_C		8A	
I_{CM}		15A	
I_B		1A	
P_{tot}		80W	
		2W	
T_{stg}		-65 to 150°C	
T_j		150°C	

MECHANICAL DATA

Dimensions in mm

Collector connected to tab.

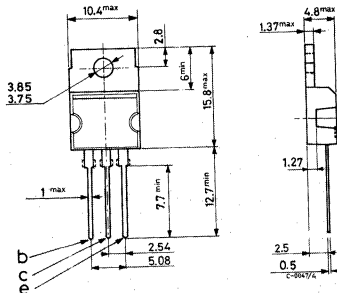

TO-220



TIP100
TIP101
TIP102

THERMAL DATA

$R_{th\ j-case}$	Thermal resistance junction-case	max	1.56	°C/W
$R_{th\ j-amb}$	Thermal resistance junction-ambient	max	62.5	°C/W

ELECTRICAL CHARACTERISTICS ($T_{case} = 25^{\circ}C$ unless otherwise specified)

Parameter	Test conditions	Min.	Typ.	Max.	Unit
I_{CEO} Collector cutoff current ($I_B = 0$)	for TIP 100 $V_{CE} = 30V$			50	μA
	for TIP 101 $V_{CE} = 40V$			50	μA
	for TIP 102 $V_{CE} = 50V$			50	μA
I_{CBO} Collector cutoff current ($I_E = 0$)	for TIP 100 $V_{CB} = 60V$			50	μA
	for TIP 101 $V_{CB} = 80V$			50	μA
	for TIP 102 $V_{CB} = 100V$			50	μA
I_{EBO} Emitter cutoff current ($I_C = 0$)	$V_{EB} = 5V$			8	mA
$V_{CE0(sus)}^*$ Collector-emitter sustaining voltage ($I_B = 0$)	$I_C = 30mA$ for TIP 100 for TIP 101 for TIP 102		60		V
			80		V
			100		V
$V_{CE(sat)}^*$ Collector-emitter saturation voltage	$I_C = 3A$ $I_B = 6mA$ $I_C = 8A$ $I_B = 80mA$			2	V
				2.5	V
V_{BE}^* Base-emitter voltage	$I_C = 8A$ $V_{CE} = 4V$			2.8	V
h_{FE}^* DC current gain	$I_C = 3A$ $V_{CE} = 4V$ $I_C = 8A$ $V_{CE} = 4V$	1000	20000		—
		200			—
V_F^* Forward voltage of commutation diode ($I_B = 0$)	$I_F = -I_C = 10A$			2.8	V

* Pulsed: pulse duration = $300\mu s$, duty cycle $\leq 2\%$.

EPITAXIAL-BASE PNP



POWER DARLINGTONS

The TIP 105, TIP 106 and TIP 107 are silicon epitaxial-base PNP transistors in monolithic Darlington configuration mounted in Jedec TO-220 plastic package intended for use in power linear and switching applications.

The complementary NPN types are the TIP 100, TIP 101 and TIP 102 respectively.

ABSOLUTE MAXIMUM RATINGS

		TIP 105	TIP 106	TIP 107
V_{CBO}	Collector-base voltage ($I_E = 0$)	-60V	-80V	-100V
V_{CEO}	Collector-emitter voltage ($I_B = 0$)	-60V	-80V	-100V
V_{EBO}	Emitter-base voltage ($I_C = 0$)		-5V	
I_C	Collector current		-8A	
I_{CM}	Collector peak current		-15A	
I_B	Base current		-1A	
P_{tot}	Total power dissipation at $T_{case} \leq 25^\circ C$ $T_{amb} \leq 25^\circ C$		80W 2W	
T_{stg}	Storage temperature		-65 to 150°C	
T_j	Junction temperature		150°C	

MECHANICAL DATA

Dimensions in mm

Collector connected to tab.

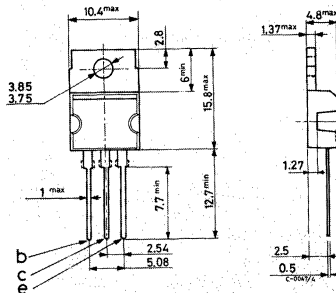

TO-220



TIP105
TIP106
TIP107

THERMAL DATA

$R_{th\ j-case}$	Thermal resistance junction-case	max	1.56	°C/W
$R_{th\ j-amb}$	Thermal resistance junction-ambient	max	62.5	°C/W

ELECTRICAL CHARACTERISTICS ($T_{case} = 25^{\circ}C$ unless otherwise specified)

Parameter	Test conditions	Min.	Typ.	Max.	Unit
I_{CEO} Collector cutoff current ($I_B = 0$)	for TIP 105 $V_{CE} = -30V$ for TIP 106 $V_{CE} = -40V$ for TIP 107 $V_{CE} = -50V$			-50 -50 -50	μA μA μA
I_{CBO} Collector cutoff current ($I_E = 0$)	for TIP 105 $V_{CB} = -60V$ for TIP 106 $V_{CB} = -80V$ for TIP 107 $V_{CB} = -100V$			-50 -50 -50	μA μA μA
I_{EBO} Emitter cutoff current ($I_C = 0$)	$V_{EB} = -5V$			-8	mA
$V_{CEO(sus)}$ * Collector-emitter sustaining voltage ($I_B = 0$)	$I_C = -30mA$ for TIP 105 for TIP 106 for TIP 107			-60 -80 -100	V V V
$V_{CE(sat)}$ * Collector-emitter saturation voltage	$I_C = -3A$ $I_B = -6mA$ $I_C = -8A$ $I_B = -80mA$			-2 -2.5	V V
$V_{BE(on)}$ * Base-emitter voltage	$I_C = -8A$ $V_{CE} = -4V$			-2.8	V
h_{FE} * DC current gain	$I_C = -3A$ $V_{CE} = -4V$ $I_C = -8A$ $V_{CE} = -4V$	1000 200	20000		— —
V_F * Forward voltage of commutation diode ($I_B = 0$)	$I_F = -I_C = -10A$			-2.8	V

* Pulsed: pulse duration = 300 μs , duty cycle $\leq 2\%$.

EPITAXIAL-BASE NPN



POWER DARLINGTONS

The TIP 110, TIP 111 and TIP 112 are silicon epitaxial-base NPN transistors in monolithic Darlington configuration in Jedec TO-220 plastic package, intended for use in medium power linear and switching applications. The complementary PNP types are the TIP 115, TIP 116 and TIP 117 respectively.

ABSOLUTE MAXIMUM RATINGS

		TIP 110	TIP 111	TIP 112
V_{CB0}	Collector-base voltage ($I_E = 0$)	60V	80V	100V
V_{CEO}	Collector-emitter voltage ($I_B = 0$)	60V	80V	100V
V_{EBO}	Emitter-base voltage ($I_C = 0$)		5V	
I_C	Collector current		2A	
I_{CM}	Collector peak current		4A	
I_B	Base current		50mA	
P_{tot}	Total power dissipation at $T_{case} \leq 25^\circ C$ $T_{amb} \leq 25^\circ C$		50W	
T_{stg}	Storage temperature		2W	
T_j	Junction temperature		-65 to 150°C	150°C

MECHANICAL DATA

Dimensions in mm

Collector connected to tab.

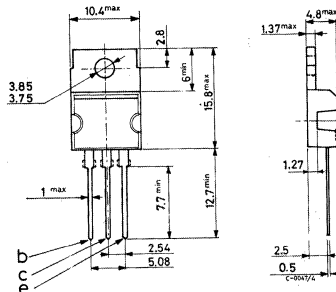

TO-220

THERMAL DATA

$R_{th\ j-case}$	Thermal resistance junction-case	max	2.5	°C/W
$R_{th\ j-amb}$	Thermal resistance junction-ambient	max	62.5	°C/W

ELECTRICAL CHARACTERISTICS ($T_{case} = 25^{\circ}C$ unless otherwise specified)

Parameter	Test conditions	Min.	Typ.	Max.	Unit
I_{CEO}	Collector cutoff current ($I_B = 0$)	for TIP 110 for TIP 111 for TIP 112	$V_{CE} = 30V$ $V_{CE} = 40V$ $V_{CE} = 50V$	2 2 2	mA mA mA
I_{CBO}	Collector cutoff current ($I_E = 0$)	for TIP 110 for TIP 111 for TIP 112	$V_{CB} = 60V$ $V_{CB} = 80V$ $V_{CB} = 100V$	1 1 1	mA mA mA
I_{EBO}	Emitter cutoff current ($I_C = 0$)	$V_{EB} = 5V$		2	mA
$V_{CEO(sus)}$	*Collector-emitter sustaining voltage ($I_B = 0$)	$I_C = 30mA$ for TIP 110 for TIP 111 for TIP 112		60 80 100	V V V
$V_{CE(sat)}$	*Collector-emitter saturation voltage	$I_C = 2A$	$I_B = 8mA$	2.5	V
$V_{BE(on)}$	*Base-emitter voltage	$I_C = 2A$	$V_{CE} = 4V$	2.8	V
h_{FE}	*DC current gain	$I_C = 1A$ $I_C = 2A$	$V_{CE} = 4V$ $V_{CE} = 4V$	1000 500	— —

* Pulsed: pulse duration = $300\mu s$, duty cycle $\leq 2\%$.

EPITAXIAL-BASE PNP



POWER DARLINGTONS

The TIP 115, TIP 116 and TIP 117 are silicon epitaxial-base PNP transistors in monolithic Darlington configuration in Jedec TO-220 plastic package, intended for use in medium power linear and switching applications.

The complementary NPN types are the TIP 110, TIP 111 and TIP 112 respectively.

ABSOLUTE MAXIMUM RATINGS

	TIP 115	TIP 116	TIP 117	
V_{CBO}	Collector-base voltage ($I_E = 0$)	-60V	-80V	-100V
V_{CEO}	Collector-emitter voltage ($I_B = 0$)	-60V	-80V	-100V
V_{EBO}	Emitter-base voltage ($I_C = 0$)		-5V	
I_C	Collector current		-2A	
I_{CM}	Collector peak current		-4A	
I_B	Base current		-50mA	
P_{tot}	Total power dissipation at $T_{case} \leq 25^\circ C$ $T_{amb} \leq 25^\circ C$		50W	2W
T_{stg}	Storage temperature		-65 to 150°C	
T_j	Junction temperature		150°C	

MECHANICAL DATA

Dimensions in mm

Collector connected to tab.

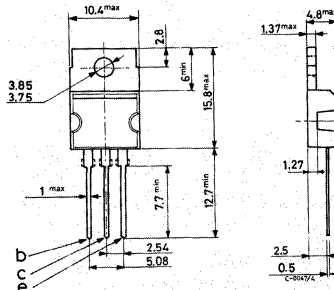

TO-220



THERMAL DATA

$R_{th\ j-case}$	Thermal resistance junction-case	max	2.5	°C/W
$R_{th\ j-amb}$	Thermal resistance junction-ambient	max	62.5	°C/W

ELECTRICAL CHARACTERISTICS ($T_{case} = 25^{\circ}C$ unless otherwise specified)

Parameter	Test conditions	Min.	Typ.	Max.	Unit
I_{CEO}	Collector cutoff current ($I_B = 0$)	for TIP 115 for TIP 116 for TIP 117	$V_{CE} = -30V$ $V_{CE} = -40V$ $V_{CE} = -50V$	-2 -2 -2	mA mA mA
I_{CBO}	Collector cutoff current ($I_E = 0$)	for TIP 115 for TIP 116 for TIP 117	$V_{CB} = -60V$ $V_{CB} = -80V$ $V_{CB} = -100V$	-1 -1 -1	mA mA mA
I_{EBO}	Emitter cutoff current ($I_C = 0$)	$V_{EB} = -5V$		-2	mA
$V_{CEO(sus)}$	* Collector-emitter sustaining voltage ($I_B = 0$)	$I_C = -30mA$ for TIP 115 for TIP 116 for TIP 117		-60 -80 -100	V V V
$V_{CE(sat)}$	* Collector-emitter saturation voltage	$I_C = -2A$	$I_B = -8mA$	-2,5	V
$V_{BE(on)}$	* Base-emitter voltage	$I_C = -2A$	$V_{CE} = -4V$	-2.8	V
h_{FE}	* DC current gain	$I_C = -1A$ $I_C = -2A$	$V_{CE} = -4V$ $V_{CE} = -4V$	1000 500	— —

* Pulsed: pulse duration = 300 μ s, duty cycle \leq 2%.

EPITAXIAL-BASE NPN



POWER DARLINGTONS

The TIP 120, TIP 121 and TIP 122 are silicon epitaxial-base NPN transistors in monolithic Darlington configuration in Jedec TO-220 plastic package, intended for use in power linear and switching applications. The complementary PNP types are the TIP 125, TIP 126 and TIP 127 respectively.

ABSOLUTE MAXIMUM RATINGS

	TIP 120	TIP 121	TIP 122
V_{CB0}	60V	80V	100V
V_{CEO}	60V	80V	100V
V_{EBO}		5V	
I_C		5A	
I_{CM}		8A	
I_B		0.1A	
P_{tot}		65W	
		2W	
T_{stg}		-65 to 150°C	
T_j		150°C	

MECHANICAL DATA

Dimensions in mm

Collector connected to tab.

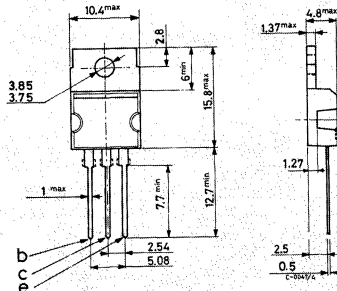

TO-220

THERMAL DATA

$R_{th\ j-case}$	Thermal resistance junction-case	max	1.92	°C/W
$R_{th\ j-amb}$	Thermal resistance junction-ambient	max	62.5	°C/W

ELECTRICAL CHARACTERISTICS ($T_{case} = 25^{\circ}C$ unless otherwise specified)

Parameter	Test conditions	Min.	Typ.	Max.	Unit
I_{CEO} Collector cutoff current ($I_B = 0$)	for TIP 120			0.5	mA
	for TIP 121			0.5	mA
	for TIP 122			0.5	mA
I_{CBO} Collector cutoff current ($I_E = 0$)	for TIP 120			0.2	mA
	for TIP 121			0.2	mA
	for TIP 122			0.2	mA
I_{EBO} Emitter cutoff current ($I_C = 0$)	$V_{EB} = 5V$			2	mA
$V_{CEO(sus)}$ *Collector-emitter sustaining voltage ($I_B = 0$)	$I_C = 30mA$ for TIP 120 for TIP 121 for TIP 122	60			V
$V_{CE(sat)}$ * Collector-emitter saturation voltage	$I_C = 3A$			2	V
	$I_C = 5A$			4	V
$V_{BE(on)}$ * Base-emitter voltage	$I_C = 3A$			2.5	V
h_{FE} * DC current gain	$I_C = 0.5A$			1000	—
	$I_C = 3A$			1000	—

* Pulsed: pulse duration = $300\mu s$, duty cycle $\leq 2\%$.

Safe operating areas

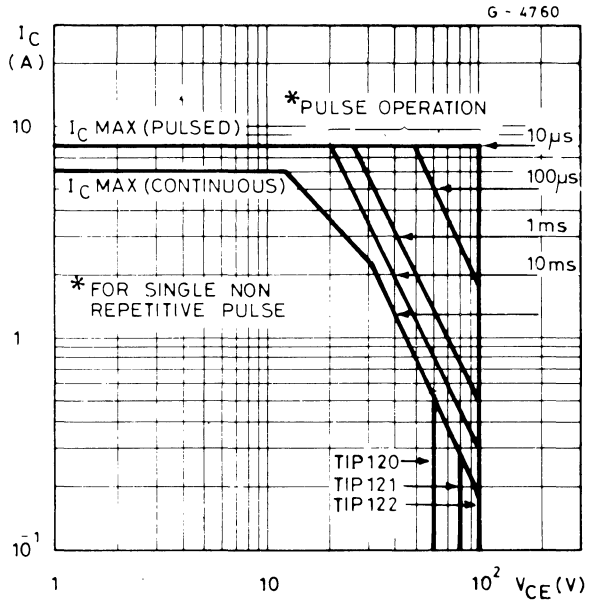

DC current gain

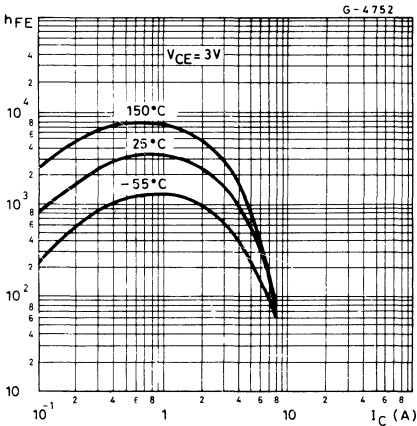

DC current gain

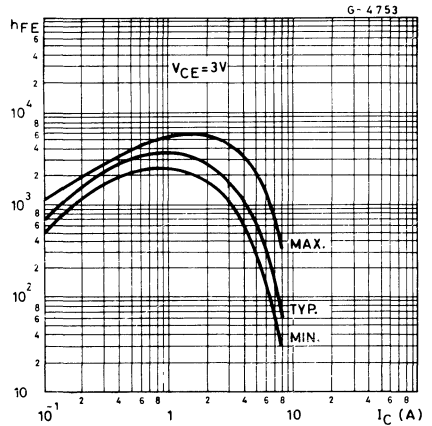

Collector-emitter saturation voltage

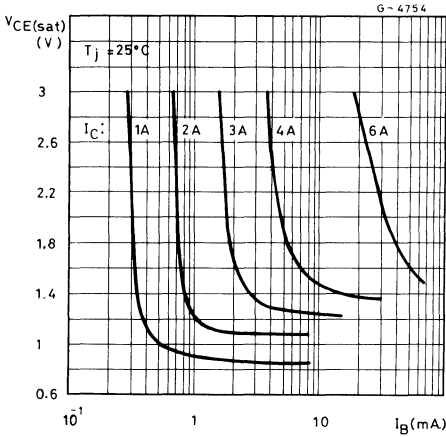

Base-emitter voltage

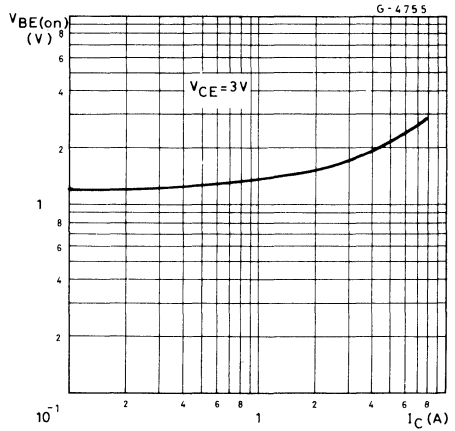

Base-emitter saturation voltage

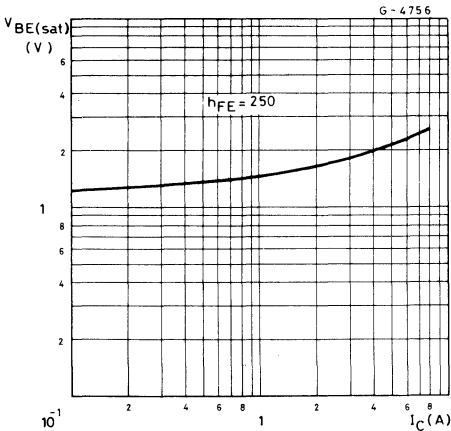

Collector-emitter saturation voltage

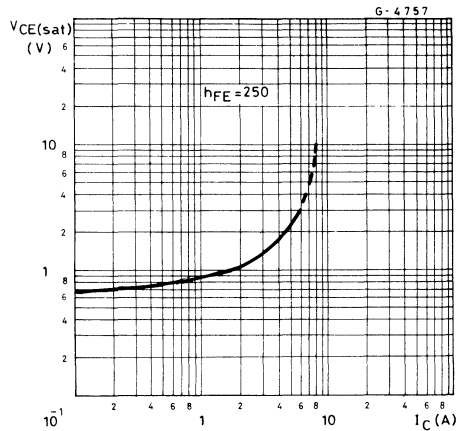

Collector cutoff current

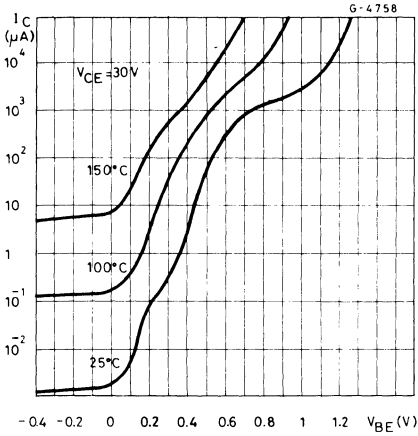

Collector base capacitance

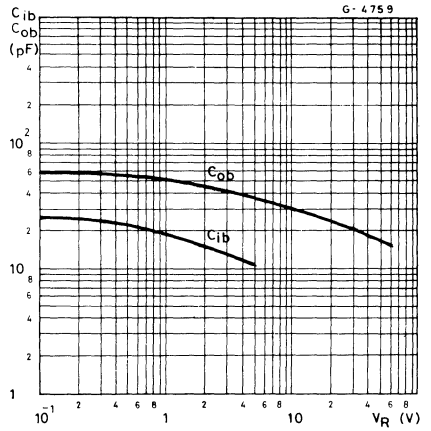

Saturated switching characteristics

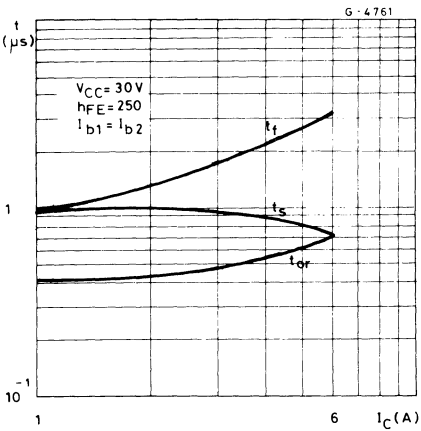



TIP125
TIP126
TIP127

EPITAXIAL-BASE PNP

POWER DARLINGTONS

The TIP 125, TIP 126 and TIP 127 are silicon epitaxial-base PNP transistors in monolithic Darlington configuration in Jedec TO-220 plastic package, intended for use in power linear and switching applications.

The complementary NPN types are the TIP 120, TIP 121 and TIP 122 respectively.

ABSOLUTE MAXIMUM RATINGS

		TIP 125	TIP 126	TIP 127
V_{CBO}	Collector-base voltage ($I_E = 0$)	-60V	-80V	-100V
V_{CEO}	Collector-emitter voltage ($I_B = 0$)	-60V	-80V	-100V
V_{EBO}	Emitter-base voltage ($I_C = 0$)		-5V	
I_C	Collector current		-5A	
I_{CM}	Collector peak current		-8A	
I_B	Base current		-0.1A	
P_{tot}	Total power dissipation at $T_{case} \leq 25^\circ C$ $T_{amb} \leq 25^\circ C$		65W 2W	
T_{stg}	Storage temperature		-65 to 150°C	
T_j	Junction temperature		150°C	

MECHANICAL DATA

Dimensions in mm

Collector connected to tab.

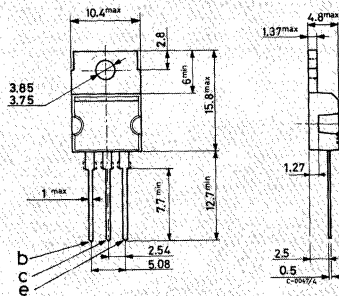

TO-220



TIP125
TIP126
TIP127

THERMAL DATA

$R_{th\ j-case}$	Thermal resistance junction-case	max	1.92	°C/W
$R_{th\ j-amb}$	Thermal resistance junction-ambient	max	62.5	°C/W

ELECTRICAL CHARACTERISTICS ($T_{case} = 25^{\circ}C$ unless otherwise specified)

Parameter	Test conditions	Min.	Typ.	Max.	Unit
I_{CEO}	Collector cutoff current ($I_B = 0$)	for TIP 125 for TIP 126 for TIP 127	$V_{CE} = -30V$ $V_{CE} = -40V$ $V_{CE} = -50V$	-0.5 -0.5 -0.5	mA mA mA
I_{CBO}	Collector cutoff current ($I_E = 0$)	for TIP 125 for TIP 126 for TIP 127	$V_{CB} = -60V$ $V_{CB} = -80V$ $V_{CB} = -100V$	-0.2 -0.2 -0.2	mA mA mA
I_{EBO}	Emitter cutoff current ($I_C = 0$)	$V_{EB} = -5V$		-2	mA
$V_{CEO(sus)}$	*Collector-emitter sustaining voltage ($I_B = 0$)	$I_C = -30mA$ for TIP 125 for TIP 126 for TIP 127		-60 -80 -100	V V V
$V_{CE(sat)}$	*Collector-emitter saturation voltage	$I_C = -3A$ $I_C = -5A$	$I_B = -12mA$ $I_B = -20mA$	-2 -4	V V
$V_{BE(on)}$	*Base-emitter voltage	$I_C = -3A$	$V_{CE} = -3V$	-2.5	V
h_{FE}	*DC current gain	$I_C = -0.5A$ $I_C = -3A$	$V_{CE} = -3V$ $V_{CE} = -3V$	1000 1000	— —

* Pulsed: pulse duration = 300 μ s, duty cycle \leq 2%.

Safe operating areas

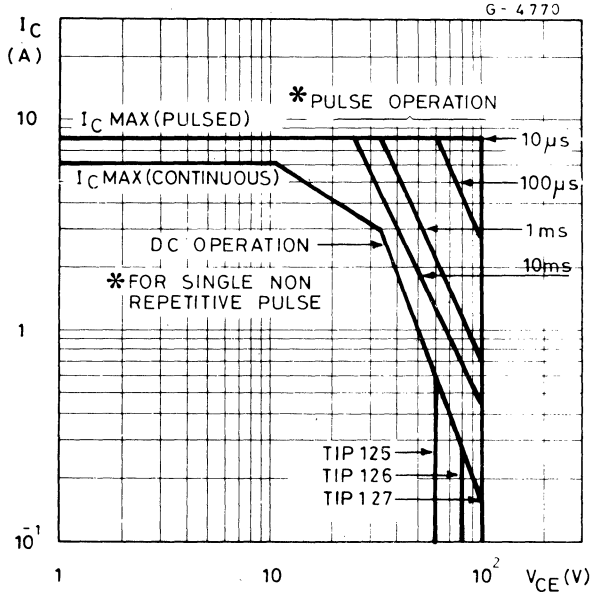

DC current gain

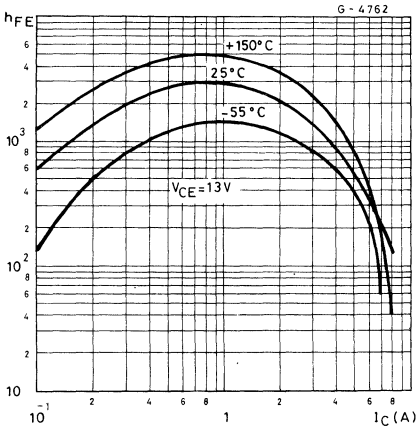

DC current gain

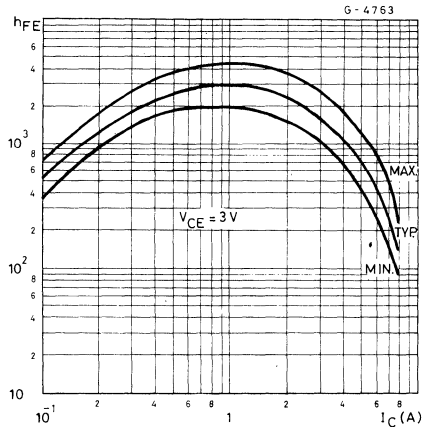

Base-emitter voltage

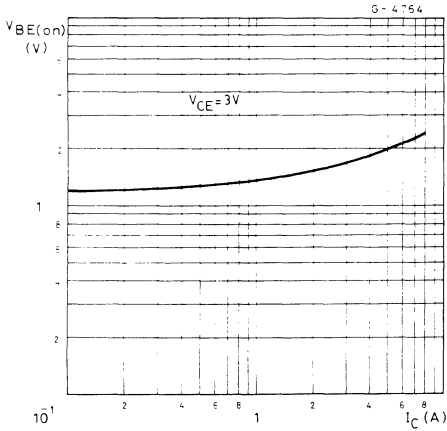

Collector-emitter saturation voltage

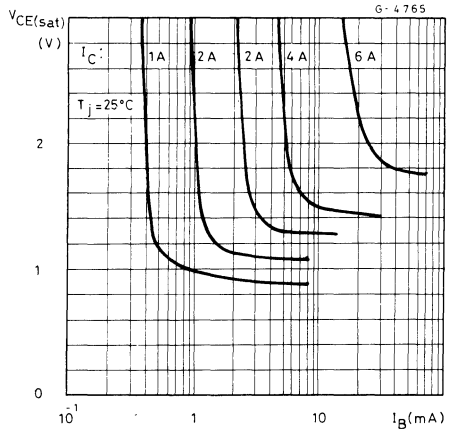

Base-emitter saturation voltage

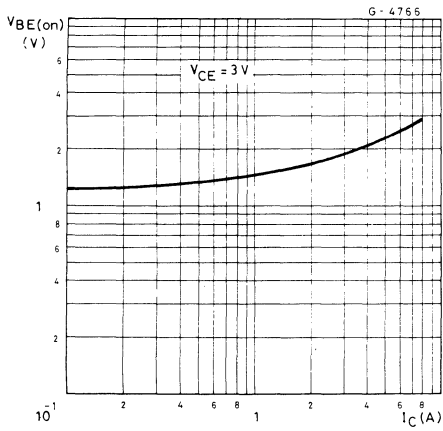

Collector-emitter saturation voltage

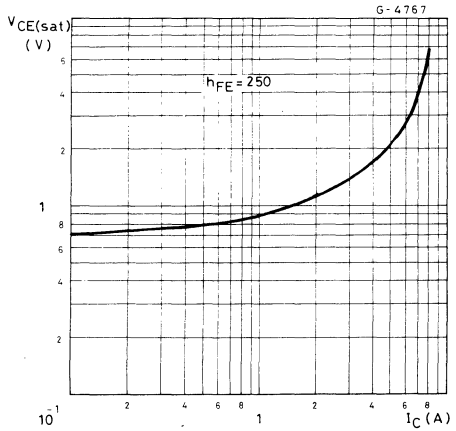



TIP125
TIP126
TIP127

Collector cutoff current

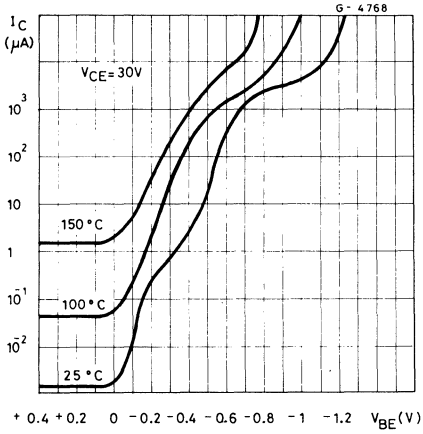

Collector base capacitance

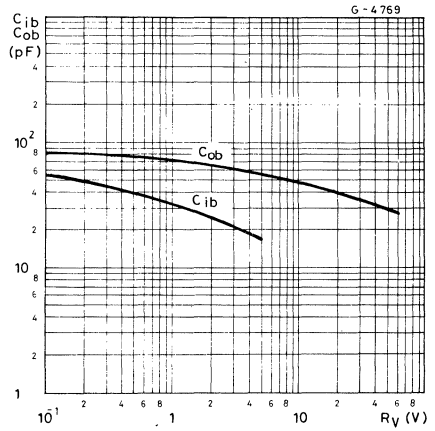

Saturated switching characteristics

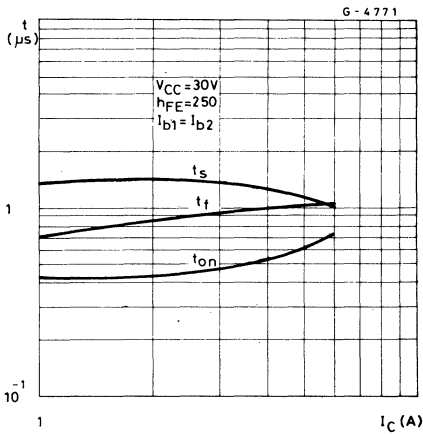

EPITAXIAL-BASE NPN

POWER DARLINGTONS

The TIP130, TIP131 and TIP 132 are silicon epitaxial-base NPN transistors in monolithic Darlington configuration mounted in Jedec T0-220 plastic package intended for use in power linear and switching applications.

The complementary PNP types are the TIP 135, TIP 136 and TIP 137 respectively.

ABSOLUTE MAXIMUM RATINGS

		TIP 130	TIP 131	TIP 132
V_{CBO}	Collector-base voltage ($I_E = 0$)	60V	80V	100V
V_{CEO}	Collector-emitter voltage ($I_B = 0$)	60V	80V	100V
V_{EBO}	Emitter-base voltage ($I_C = 0$)		5V	
I_C	Collector current		8A	
I_{CM}	Collector peak current		12A	
I_B	Base current		0.3A	
P_{tot}	Total power dissipation at $T_{case} \leq 25^\circ C$ $T_{amb} \leq 25^\circ C$		70W	
T_{stg}	Storage temperature		2W	
T_j	Junction temperature		-65 to 150°C	
			150°C	

MECHANICAL DATA

Dimensions in mm

Collector connected to tab.

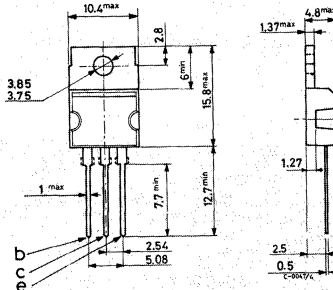

TO-220



TIP130
TIP131
TIP132

THERMAL DATA

$R_{th\ j-case}$	Thermal resistance junction-case	max	1.78	°C/W
$R_{th\ j-amb}$	Thermal resistance junction-ambient	max	62.5	°C/W

ELECTRICAL CHARACTERISTICS ($T_{case} \cong 25^{\circ}C$ unless otherwise specified)

Parameter		Test conditions		Min.	Typ.	Max.	Unit
I_{CEO}	Collector cutoff current ($I_B = 0$)	for TIP 130	$V_{CE} = 30V$			0.5	mA
		for TIP 131	$V_{CE} = 40V$			0.5	mA
		for TIP 132	$V_{CE} = 50V$			0.5	mA
I_{CBO}	Collector cutoff current ($I_E = 0$)	for TIP 130	$V_{CB} = 60V$			0.2	mA
		for TIP 131	$V_{CB} = 80V$			0.2	mA
		for TIP 132	$V_{CB} = 100V$			0.2	mA
I_{EBO}	Emitter cutoff current ($I_C = 0$)	$V_{EB} = 5V$				5	mA
$V_{CEO(sus)}$	*Collector-emitter sustaining voltage ($I_B = 0$)	$I_C = 30mA$ for TIP 130 for TIP 131 for TIP 132		60			V
$V_{CE(sat)}$	*Collector-emitter saturation voltage	$I_C = 4A$	$I_B = 16mA$			2	V
		$I_C = 6A$	$I_B = 30mA$			3	V
V_{BE}	*Base-emitter voltage	$I_C = 4A$	$V_{CE} = 4V$			2.5	V
h_{FE}	*DC current gain	$I_C = 1A$	$V_{CE} = 4V$	500			—
		$I_C = 4A$	$V_{CE} = 4V$	1000	15000		—

* Pulsed: pulse duration = $300\mu s$, duty cycle $\leq 2\%$

EPITAXIAL-BASE PNP



POWER DARLINGTONS

The TIP 135, TIP 136 and TIP 137 are silicon epitaxial-base PNP transistors in monolithic Darlington configuration in Jedec TO-220 plastic package, intended for use in power linear and switching applications.

The complementary NPN types are the TIP 130, TIP 131 and TIP 132 respectively.

ABSOLUTE MAXIMUM RATINGS

		TIP 135	TIP 136	TIP 137
V_{CBO}	Collector-base voltage ($I_E = 0$)	-60V	-80V	-100V
V_{CEO}	Collector-emitter voltage ($I_B = 0$)	-60V	-80V	-100V
V_{EBO}	Emitter-base voltage ($I_C = 0$)		-5V	
I_C	Collector current		-8A	
I_{CM}	Collector peak current		-12A	
I_B	Base current		-0.3A	
P_{tot}	Total power dissipation at $T_{case} \leq 25^\circ C$ $T_{amb} \leq 25^\circ C$		70W	
T_{stg}	Storage temperature		2W	
T_j	Junction temperature		-65 to 150°C	
			150°C	

MECHANICAL DATA

Dimensions in mm

Collector connected to tab.

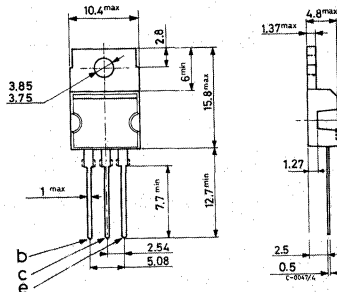

TO-220



TIP135
TIP136
TIP137

THERMAL DATA

$R_{th\ j-case}$	Thermal resistance junction-case	max	1.78	°C/W
$R_{th\ j-amb}$	Thermal resistance junction-ambient	max	62.5	°C/W

ELECTRICAL CHARACTERISTICS ($T_{case} = 25^{\circ}C$ unless otherwise specified)

Parameter	Test conditions	Min.	Typ.	Max.	Unit
I_{CEO}	Collector cutoff current ($I_B = 0$)	for TIP 135 for TIP 136 for TIP 137	$V_{CE} = -30V$ $V_{CE} = -40V$ $V_{CE} = -50V$	-0.5 -0.5 -0.5	mA
I_{CBO}	Collector cutoff current ($I_E = 0$)	for TIP 135 for TIP 136 for TIP 137	$V_{CB} = -60V$ $V_{CB} = -80V$ $V_{CB} = -100V$	-0.2 -0.2 -0.2	mA
I_{EBO}	Emitter cutoff current ($I_C = 0$)	$V_{EB} = -5V$		-5	mA
$V_{CEO(sus)}$ *	Collector-emitter sustaining voltage ($I_B = 0$)	$I_C = -30mA$ for TIP 135 for TIP 136 for TIP 137		-60 -80 -100	V
$V_{CE(sat)}$ *	Collector-emitter saturation voltage	$I_C = -4A$ $I_C = -6A$	$I_B = -16mA$ $I_B = -30mA$	-2 -3	V
$V_{BE(on)}$ *	Base-emitter voltage	$I_C = -4A$	$V_{CE} = -4V$	-2.5	V
h_{FE} *	DC current gain	$I_C = -1A$ $I_C = -4A$	$V_{CE} = -4V$ $V_{CE} = -4V$	500 1000	15000 —

* Pulsed: pulse duration = $300\mu s$, duty cycle $\leq 2\%$.

EPITAXIAL-BASE NPN/PNP

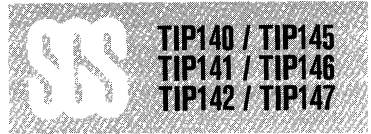

POWER DARLINGTONS

The TIP140, TIP141, TIP142 are silicon epitaxial base NPN transistors in monolithic Darlington configuration and are mounted in SOT-93 plastic package. They are intended for use in power linear and switching applications.

The complementary PNP types are TIP145, TIP146, TIP147 respectively.

ABSOLUTE MAXIMUM RATINGS

	NPN *PNP	TIP140 TIP145	TIP141 TIP146	TIP142 TIP147
V_{CBO}	Collector-base voltage ($I_E = 0$)	60V	80V	100V
V_{CEO}	Collector-emitter voltage ($I_B = 0$)	60V	80V	100V
V_{EBO}	Emitter base voltage ($I_C = 0$)		5V	
I_C	Collector current		10A	
I_{CM}	Collector peak current (repetitive)		20A	
I_B	Base current		0.5A	
P_{tot}	Total power dissipation at $T_{case} \leq 25^\circ C$		125W	
T_{stg}	Storage temperature		-65 to 150°C	
T_j	Junction temperature		150°C	

* For PNP types voltage and current values are negative.

MECHANICAL DATA

Dimensions in mm

Collector connected to tab.

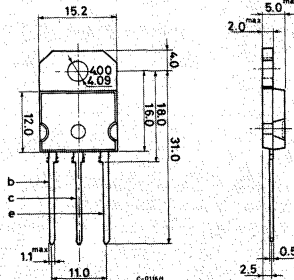

(sim. to TO-218) SOT-93



TIP140 / TIP145
TIP141 / TIP146
TIP142 / TIP147

THERMAL DATA

$R_{th\ j-case}$	Thermal resistance junction-case	max	1	$^{\circ}C/W$
------------------	----------------------------------	-----	---	---------------

ELECTRICAL CHARACTERISTICS ($T_{case} = 25^{\circ}C$ unless otherwise specified)

Parameter	Test conditions	Min.	Typ.	Max.	Unit
I_{CBO} Collector cutoff current ($I_E = 0$)	for TIP140/5 $V_{CB} = 60V$ for TIP141/6 $V_{CB} = 80V$ for TIP142/7 $V_{CB} = 100V$			1 1 1	mA mA mA
I_{CEO} Collector cutoff current ($I_B = 0$)	for TIP140/5 $V_{CB} = 30V$ for TIP141/6 $V_{CE} = 40V$ for TIP142/7 $V_{CE} = 50V$			2 2 2	mA mA mA
I_{EBO} Emitter cutoff current ($I_C = 0$)	$V_{EBO} = 5V$			2	mA
$V_{CEO(sus)}$ * Collector emitter sustaining voltage ($I_B = 0$)	$I_C = 30\text{ mA}$ for TIP140/5 for TIP141/6 for TIP142/7	60 80 100			V V V
$V_{CE(sat)}$ * Collector-emitter saturation voltage	$I_C = 5A$ $I_B = 10\text{ mA}$ $I_C = 10A$ $I_B = 40\text{ mA}$			2 3	V V
V_{BE} * Base-emitter voltage	$I_C = 10A$ $V_{CE} = 4V$			3	V
h_{FE} * DC current gain	$I_C = 5A$ $V_{CE} = 4V$ $I_C = 10A$ $V_{CE} = 4V$	1000 500			— —
t_{on} Turn-on time	$I_C = 10A$ $I_{B1} = 40\text{ mA}$		0.9		μs
t_{off} Turn-off time	$I_{B2} = -40\text{ mA}$ $R_L = 3\Omega$		4		μs

* Pulsed: pulse duration = 200 μs , duty cycle = 1.5%.

For PNP devices voltage and current values are negative

Safe operating areas

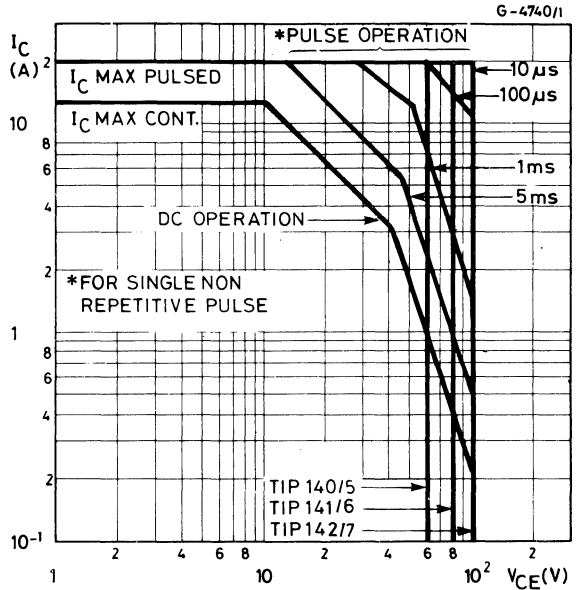

DC current gain (TIP140/1/2)

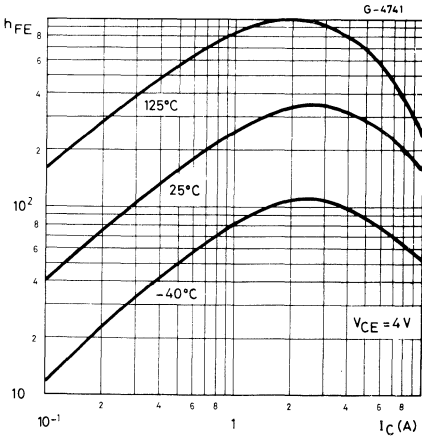

DC transconductance (TIP140/1/2)

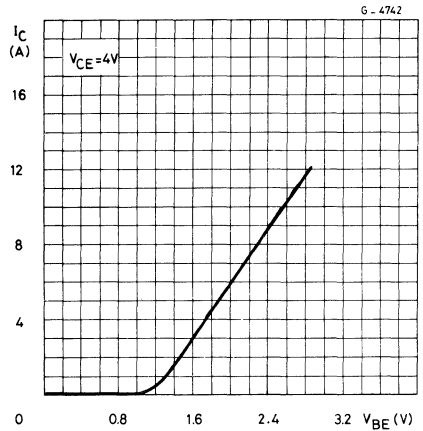



TIP140 / TIP145
TIP141 / TIP146
TIP142 / TIP147

Collector-emitter saturation voltage
(TIP140/1/2)

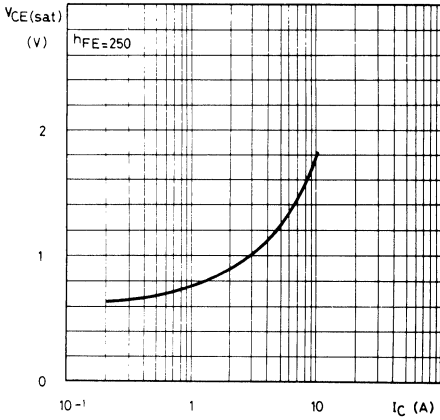

Collector-emitter saturation voltage
(TIP140/1/2)

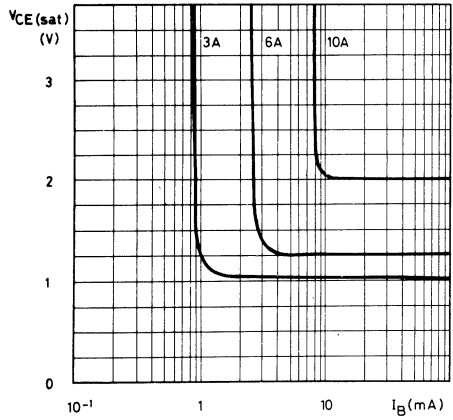

DC current gain (TIP145/6/7)

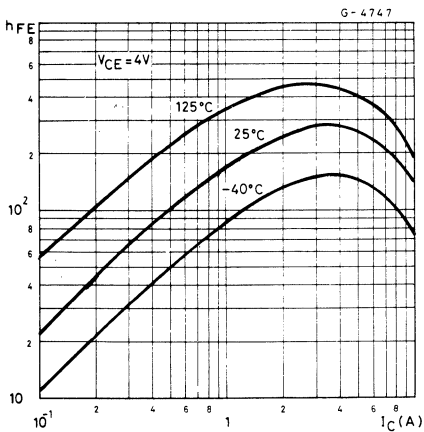

DC transconductance (TIP145/6/7)

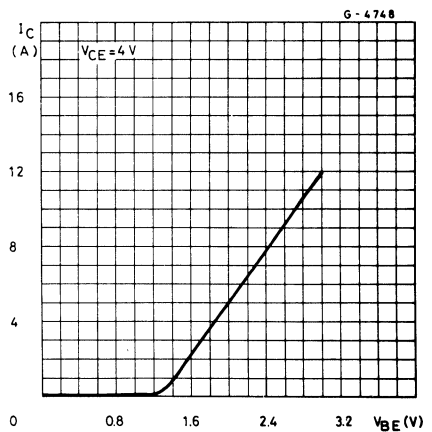

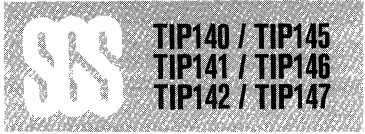

Collector-emitter saturation voltage
(TIP145/6/7)

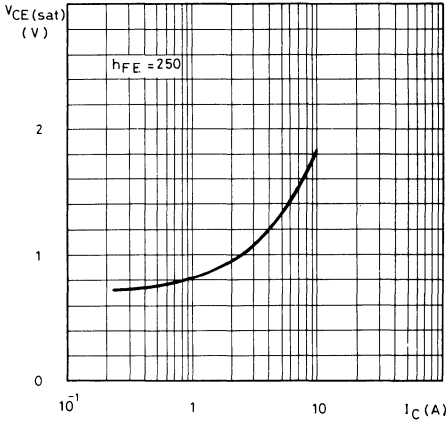

Collector-emitter saturation voltage
(TIP145/6/7)

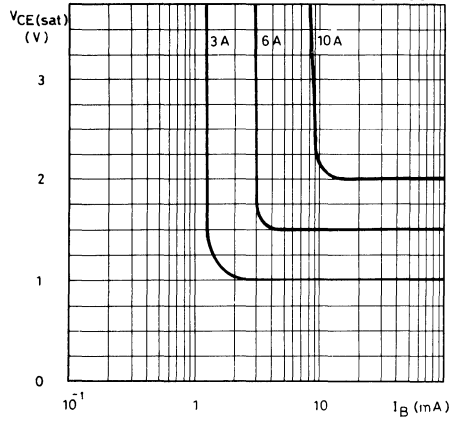



2N3055E

EPITAXIAL-BASE NPN

POWER LINEAR AND SWITCHING APPLICATIONS

The 2N 3055E is a silicon epitaxial-base NPN transistor in Jedec TO-3 metal case. It is intended for power switching circuits, series and shunt regulators, output stages and high fidelity amplifiers.

ABSOLUTE MAXIMUM RATINGS

V_{CBO}	Collector-base voltage ($I_E = 0$)	100	V
V_{CER}	Collector-emitter voltage ($R_{BE} = 100\Omega$)	70	V
V_{CEO}	Collector-emitter voltage ($I_B = 0$)	60	V
V_{EBO}	Emitter-base voltage ($I_C = 0$)	7	V
I_C	Collector current	15	A
I_B	Base current	7	A
P_{tot}	Total power dissipation at $T_{case} \leq 25^\circ C$	115	W
T_{stg}	Storage temperature	-65 to 200	$^\circ C$
T_j	Junction temperature	200	$^\circ C$

INTERNAL SCHEMATIC DIAGRAM

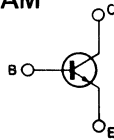

MECHANICAL DATA

Dimensions in mm

Collector connected to case

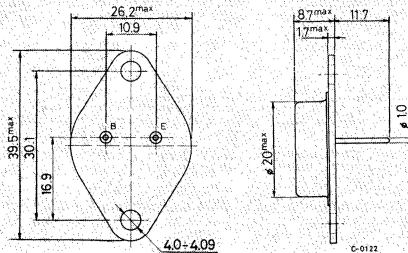

TO-3



2N3055E

THERMAL DATA

$R_{th\ j-case}$	Thermal resistance junction-case	max	1.5 °C/W
------------------	----------------------------------	-----	----------

ELECTRICAL CHARACTERISTICS ($T_{case} = 25\text{ °C}$ unless otherwise specified)

Parameter	Test conditions	Min.	Typ.	Max.	Unit
I_{CEV}	Collector cutoff current ($V_{BE} = -1.5V$)	$V_{CE} = 100\text{ V}$ $V_{CE} = 100\text{ V}$		1 5	mA mA
I_{CEO}	Collector cutoff current ($I_B = 0$)	$V_{CE} = 30\text{ V}$		0.7	mA
I_{EBO}	Emitter cutoff current ($I_C = 0$)	$V_{EB} = 7\text{ V}$		5	mA
$V_{CER(sus)}$	*Collector-emitter sust. voltage ($R_{BE} = 100\Omega$)	$I_C = 200\text{ mA}$		70	V
$V_{CEO(sus)}$	*Collector-emitter sust. voltage ($I_B = 0$)	$I_C = 200\text{ mA}$		60	V
$V_{CE(sat)}$	*Collector-emitter saturation voltage	$I_C = 4\text{ A}$ $I_B = 400\text{mA}$ $I_C = 10\text{ A}$ $I_B = 3.3\text{A}$		1 3	V V
V_{BE}	*Base-emitter voltage	$I_C = 4\text{ A}$ $V_{CE} = 4\text{ V}$		1.5	V
h_{FE}	DC current gain				
	Group 4	$I_C = 0.5\text{ A}$ $V_{CE} = 4\text{ V}$	20	50	—
	Group 5	$I_C = 0.5\text{ A}$ $V_{CE} = 4\text{ V}$	35	75	—
	Group 6	$I_C = 0.5\text{ A}$ $V_{CE} = 4\text{ V}$	60	145	—
	Group 7	$I_C = 0.5\text{ A}$ $V_{CE} = 4\text{ V}$ $I_C = 4\text{ A}$ $V_{CE} = 4\text{ V}$ $I_C = 10\text{ A}$ $V_{CE} = 4\text{ V}$	120 20 5	250 70	— — —
h_{FE1}/h_{FE2}	*Matched pair	$I_C = 0.5\text{ A}$ $V_{CE} = 4\text{ V}$		1.6	—
f_T	Transition frequency	$I_C = 1\text{ A}$ $V_{CE} = 4\text{ V}$	2.5		MHz
$I_{s/b}$	** Second breakdown collector current	$V_{CE} = 40\text{ V}$	2.87		A

* Pulsed: pulse duration = 300 μ s, duty cycle = 1.5%

** Pulsed: 1s, non repetitive pulse



2N3055E

Safe operating areas

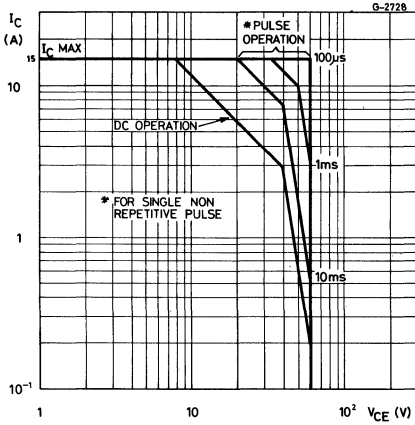

DC current gain

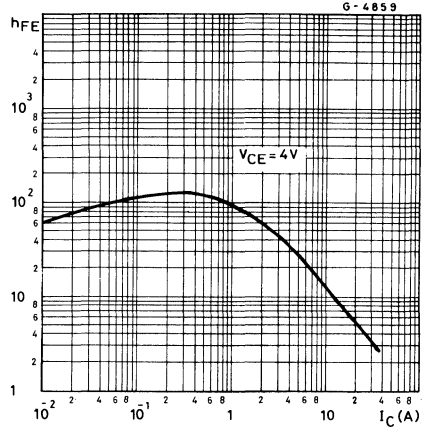

Collector-emitter saturation voltage

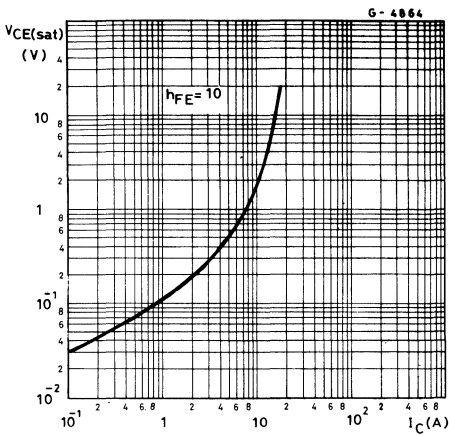

Base-emitter saturation voltage

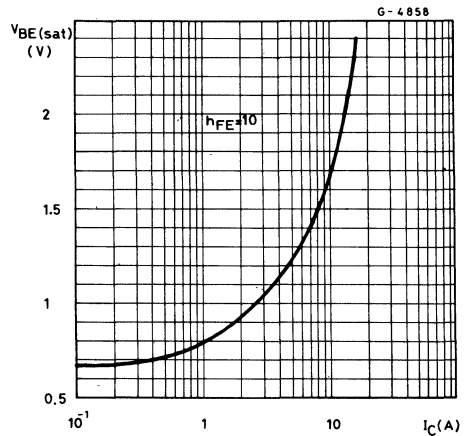



Small signal current gain

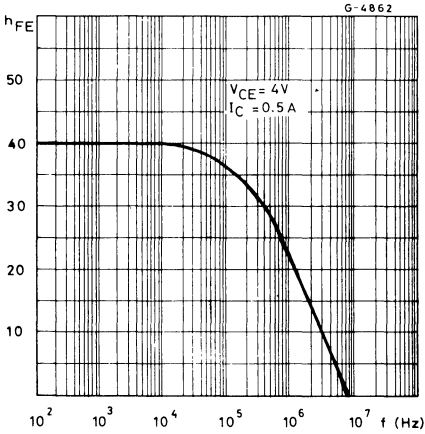

Collector-base capacitance

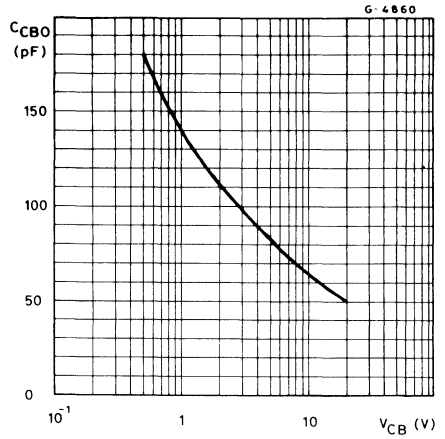

Saturated switching characteristics

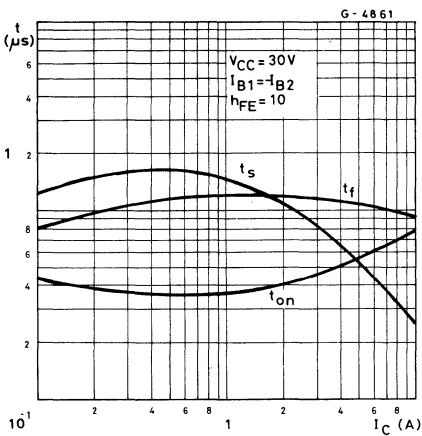

Power rating chart

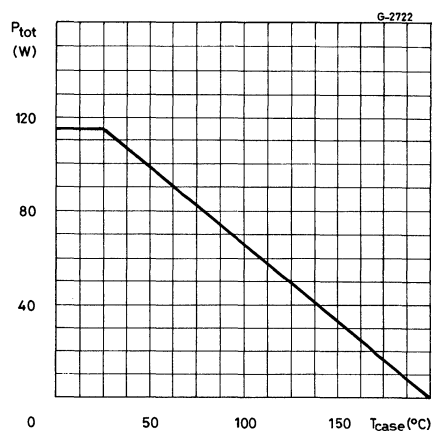



2N3439
2N3440

EPITAXIAL PLANAR NPN

HIGH VOLTAGE TRANSISTORS

The 2N3439, 2N3440 are high voltage silicon epitaxial planar transistors designed for use in consumer and industrial line-operated applications. These devices are particularly suited as drivers in high-voltage low current inverters, switching and series regulators.

ABSOLUTE MAXIMUM RATINGS

		2N3439	2N3440
V_{CBO}	Collector-base voltage ($I_E = 0$)	450V	300V
V_{CEO}	Collector-emitter voltage ($I_B = 0$)	350V	250V
V_{EBO}	Emitter-base voltage ($I_C = 0$)		7V
I_C	Collector current		1A
I_B	Base current		0.5A
P_{tot}	Total power dissipation at $T_{case} \leq 25^\circ C$ $T_{amb} \leq 50^\circ C$		10W
T_{stg}	Storage temperature		1W
T_j	Junction temperature	-65 to 200°C	200°C

INTERNAL SCHEMATIC DIAGRAM

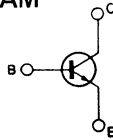

MECHANICAL DATA

Dimensions in mm

Collector connected to case

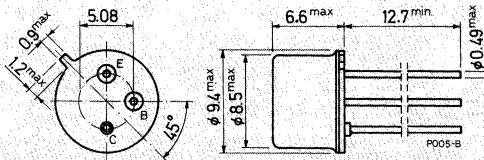

TO-39



2N3439
2N3440

THERMAL DATA

$R_{th\ j-case}$	Thermal resistance junction-case	max	17.5 °C/W
$R_{th\ j-amb}$	Thermal resistance junction-ambient	max	150 °C/W

ELECTRICAL CHARACTERISTICS ($T_{case} = 25^{\circ}C$ unless otherwise specified)

Parameter	Test conditions	Min.	Typ.	Max.	Unit
I_{CBO}	Collector cutoff current ($I_E = 0$)	for 2N3439 for 2N3440	$V_{CB} = 360V$ $V_{CB} = 250V$	20 20	μA μA
I_{CEO}	Collector cutoff current ($I_B = 0$)	for 2N3439 for 2N3440	$V_{CE} = 300V$ $V_{CE} = 200V$	20 50	μA μA
I_{CEX}	Collector cutoff current ($V_{BE} = -1.5V$)	for 2N3439 for 2N3440	$V_{CE} = 450V$ $V_{CE} = 300V$	500 500	μA μA
I_{EBO}	Emitter cutoff current ($I_C = 0$)	$V_{EB} = 6V$		20	μA
$V_{CEO(sus)}$	*Collector-emitter sustaining voltage ($I_B = 0$)	$I_C = 50mA$ for 2N3439 for 2N3440		350 250	V V
$V_{CE(sat)}$	*Collector-emitter saturation voltage	$I_C = 50mA$ $I_B = 4mA$		0.5	V
$V_{BE(sat)}$	*Base-emitter saturation voltage	$I_C = 50mA$ $I_B = 4mA$		1.3	V
C_{ob}	Output capacitance	$V_{CB} = 10V, f = 1MHz$		10	pF
h_{FE}	*DC current gain	$I_C = 20mA$ for 2N3439 $I_C = 2mA$	$V_{CE} = 10V$ $V_{CE} = 10V$	40 30	160 —
h_{fe}	Small signal current gain	$I_C = 5mA$ $f = 1KHz$	$V_{CE} = 10V$	25	—
f_T	Transition frequency	$I_C = 10mA$ $f = 5MHz$	$V_{CE} = 10V$	15	MHz

* Pulsed: pulse duration = 300 μs , duty cycle $\leq 2\%$

Safe operating areas

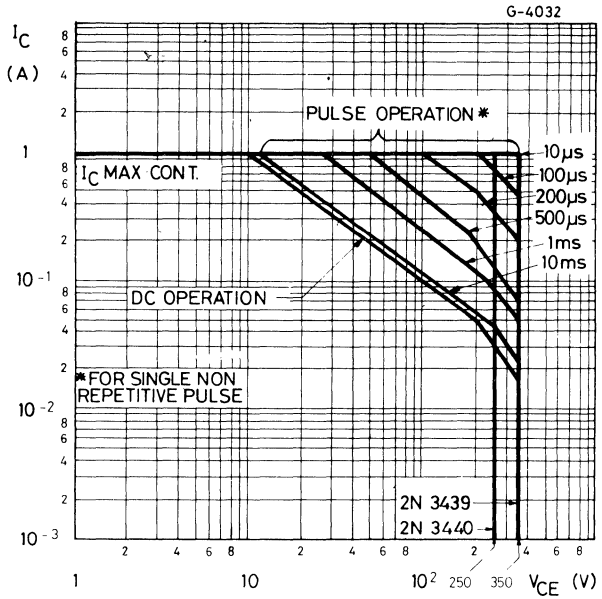

DC current gain

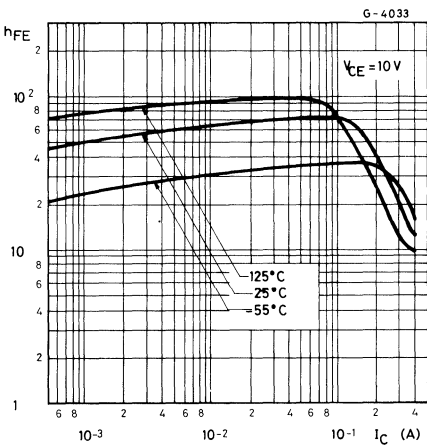

Collector-emitter saturation voltage

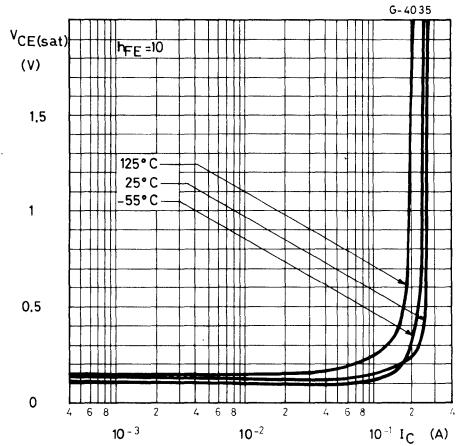

Base emitter voltage

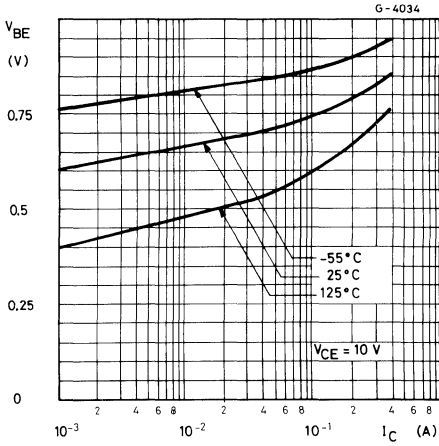

Transition frequency

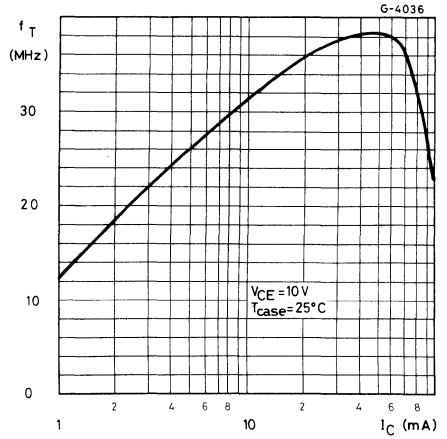

Power rating chart

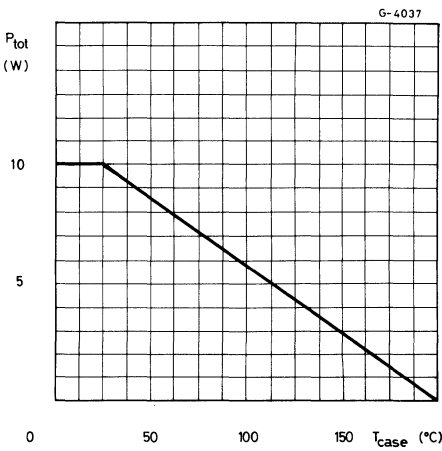



EPITAXIAL-BASE NPN

POWER LINEAR AND SWITCHING APPLICATIONS

The 2N 3713, 2N 3714, 2N 3715 and 2N 3716 are silicon epitaxial-base NPN power transistors in Jedec TO-3 metal case. They are intended for use in power linear and switching applications.

The complementary PNP types are the 2N 3789, 2N 3790, 2N 3791 and 2N 3792 respectively.

ABSOLUTE MAXIMUM RATINGS

		2N3713 2N3715	2N3714 2N3716
V_{CBO}	Collector-base voltage ($I_E = 0$)	80V	100V
V_{CEO}	Collector-emitter voltage ($I_B = 0$)	60V	80V
V_{EBO}	Emitter-base voltage ($I_C = 0$)		7V
I_C	Collector current		10A
I_B	Base current		4A
P_{tot}	Total power dissipation at $T_{case} \leq 25^\circ C$		150W
T_{stg}	Storage temperature		-65 to 200°C
T_j	Junction temperature		200°C

INTERNAL SCHEMATIC DIAGRAM

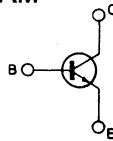

MECHANICAL DATA

Dimensions in mm

Collector connected to case

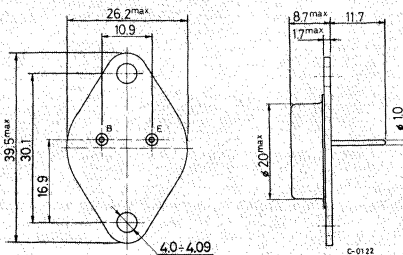

TO-3



THERMAL DATA

$R_{th\ j-case}$	Thermal resistance junction-case	max 1.17 °C/W
------------------	----------------------------------	---------------

ELECTRICAL CHARACTERISTICS ($T_{case} = 25\text{ °C}$ unless otherwise specified)

Parameter	Test conditions	Min.	Typ.	Max.	Unit
I_{CEX} Collector cutoff current ($V_{BE} = -1.5\text{ V}$)	$V_{CE} = 80\text{ V}$ for 2N3713 and 2N3715			1	mA
	$V_{CE} = 100\text{ V}$ for 2N3714 and 2N3716			1	mA
	$T_{case} = 150\text{ °C}$ $V_{CE} = 60\text{ V}$ for 2N3713 and 2N3715			10	mA
	$V_{CE} = 80\text{ V}$ for 2N3714 and 2N3716			10	mA
I_{EBO} Emitter cutoff current ($I_C = 0$)	$V_{EB} = 7\text{ V}$			5	mA
$V_{CEO(sus)}$ * Collector-emitter sustaining voltage ($I_B = 0$)	$I_C = 200\text{ mA}$ for 2N3713 and 2N3715 for 2N3714 and 2N3716	60			V
		80			V
$V_{CE(sat)}$ * Collector-emitter saturation voltage	$I_C = 5\text{ A}$ $I_B = 0.5\text{ A}$ for 2N3713 and 2N3714 for 2N3715 and 2N3716			1	V
				0.8	V
$V_{BE(sat)}$ * Base-emitter saturation voltage	$I_C = 5\text{ A}$ $I_B = 0.5\text{ A}$ for 2N3713 and 2N3714 for 2N3715 and 2N3716			2	V
				1.5	V
V_{BE} * Base-emitter voltage	$I_C = 3\text{ A}$ $V_{CE} = 2\text{ V}$			1.5	V
h_{FE} * DC current gain	$I_C = 1\text{ A}$ $V_{CE} = 2\text{ V}$ for 2N3713 and 2N3714 for 2N3715 and 2N3716	25		90	—
		50		150	—
	$I_C = 3\text{ A}$ $V_{CE} = 2\text{ V}$ for 2N3713 and 2N3714 for 2N3715 and 2N3716	15		—	—
		30		120	—
	$I_C = 10\text{ A}$ $V_{CE} = 4\text{ V}$	5		—	—
f_T Transition frequency	$I_C = 0.5\text{ A}$ $V_{CE} = 10\text{ V}$	4			MHz

* Pulsed: pulse duration = 300 μs , duty cycle = 1.5%



Safe operating areas

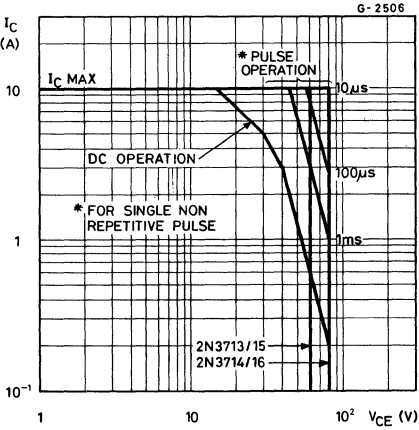

DC current gain

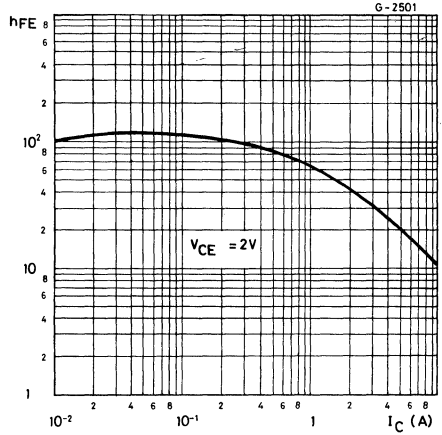

DC transconductance

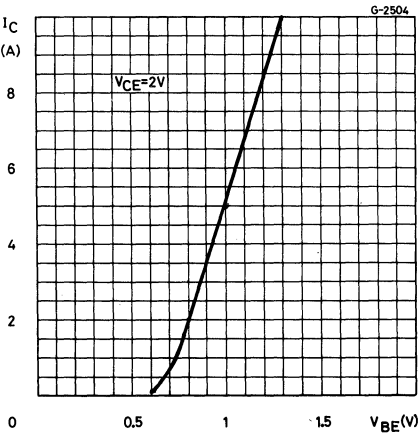

Collector-emitter saturation voltage

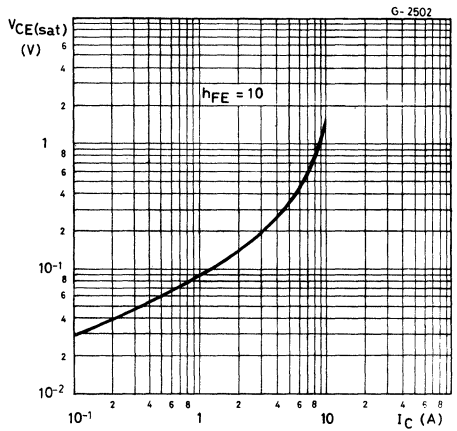



Base-emitter saturation voltage

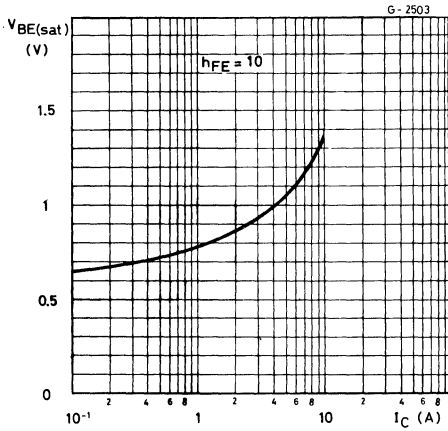

Transition frequency

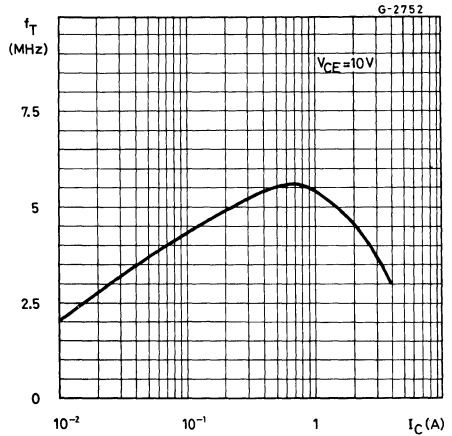

Collector-base capacitance

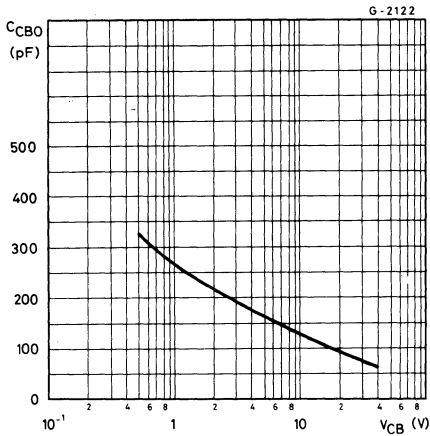

Saturated switching characteristics

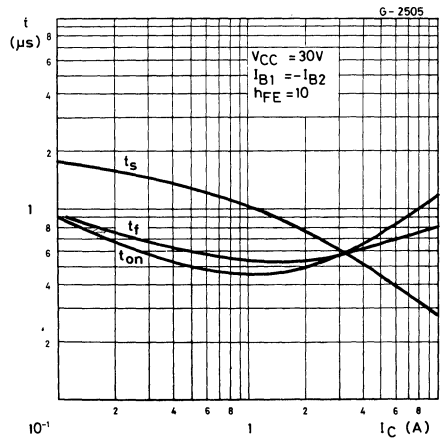

POWER LINEAR AND SWITCHING APPLICATIONS

The 2N 3789, 2N 3790, 2N 3791 and 2N 3792 are silicon epitaxial-base PNP power transistors in Jedec TO-3 metal case. They are intended for use in power linear and switching applications.

The complementary NPN types are the 2N 3713, 2N 3714, 2N 3715 and 2N 3716 respectively.

ABSOLUTE MAXIMUM RATINGS

		2N3789 2N3791	2N3790 2N3792
V_{CBO}	Collector-base voltage ($I_E = 0$)	-60V	-80V
V_{CEO}	Collector-emitter voltage ($I_B = 0$)	-60V	-80V
V_{EBO}	Emitter-base voltage ($I_C = 0$)		-7V
I_C	Collector current		-10A
I_B	Base current		-4A
P_{tot}	Total power dissipation $T_{case} \leq 25^\circ C$		150W
T_{stg}	Storage temperature		-65 to 200°C
T_j	Junction temperature		200 °C

INTERNAL SCHEMATIC DIAGRAM

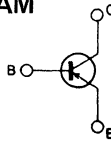

MECHANICAL DATA

Dimensions in mm

Collector connected to case

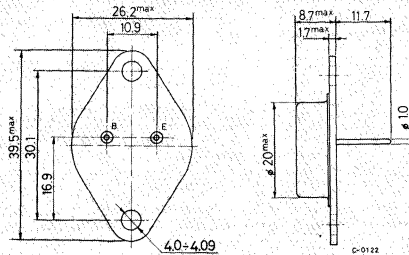

TO-3



2N3789
2N3790
2N3791
2N3792

THERMAL DATA

$R_{th\ j-case}$	Thermal resistance junction-case	max 1.17 °C/W
------------------	----------------------------------	---------------

ELECTRICAL CHARACTERISTICS ($T_{case} = 25\text{ °C}$ unless otherwise specified)

Parameter	Test conditions	Min.	Typ.	Max.	Unit
I_{CEX} Collector-emitter cutoff current ($V_{BE} = 1.5\text{ V}$)	$V_{CE} = -60\text{ V}$ for 2N3789 and 2N3791			-1	mA
	$V_{CE} = -80\text{ V}$ for 2N3790 and 2N3792			-1	mA
	$T_{case} = 150\text{ °C}$ $V_{CE} = -60\text{ V}$ for 2N3789 and 2N3791			-5	mA
	$V_{CE} = -80\text{ V}$ for 2N3790 and 2N3792			-5	mA
I_{EBO} Emitter cutoff current ($I_C = 0$)	$V_{EB} = -7\text{ V}$			-5	mA
$V_{CEO(sus)}$ * Collector-emitter sustaining voltage ($I_B = 0$)	$I_C = -200\text{ mA}$ for 2N3789 and 2N3791 for 2N3790 and 2N3792	-60		-80	V V
$V_{CE(sat)}$ * Collector-emitter saturation voltage	$I_C = -4\text{ A}$ $I_B = -0.4\text{ A}$ for 2N3789 and 2N3790			-1	V
	$I_C = -5\text{ A}$ $I_B = -0.5\text{ A}$ for 2N3791 and 2N3792			-1	V
$V_{BE(sat)}$ * Base-emitter saturation voltage	$I_C = -4\text{ A}$ $I_B = -0.4\text{ A}$ for 2N3789 and 2N3790			-2	V
	$I_C = -5\text{ A}$ $I_B = -0.5\text{ A}$ for 2N3791 and 2N3792			-1.5	V
h_{FE} * DC current gain	$I_C = -1\text{ A}$ $V_{CE} = -2\text{ V}$ for 2N3789 and 2N3790 for 2N3791 and 2N3792	25		90	— —
	$I_C = -3\text{ A}$ $V_{CE} = -2\text{ V}$ for 2N3789 and 2N3790 for 2N3791 and 2N3792	50		150	— —
	$I_C = -1\text{ A}$ $V_{CE} = -4\text{ V}$ for 2N3789 and 2N3790 for 2N3791 and 2N3792	15		120	— —
	$I_C = -3\text{ A}$ $V_{CE} = -4\text{ V}$ for 2N3789 and 2N3790 for 2N3791 and 2N3792	30		120	— —
	$I_C = -10\text{ A}$ $V_{CE} = -4\text{ V}$ for 2N3789 and 2N3790 for 2N3791 and 2N3792	5		—	— —
f_T Transition frequency	$I_C = -0.5\text{ A}$ $V_{CE} = -10\text{ V}$	4			MHz

* Pulsed: pulse duration = 300 μs , duty cycle = 1.5%



2N3789
2N3790
2N3791
2N3792

Safe operating areas

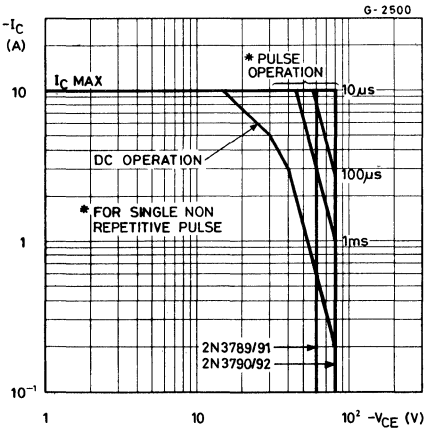

DC current gain

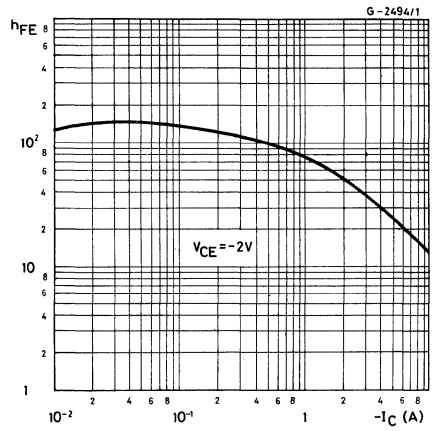

DC transconductance

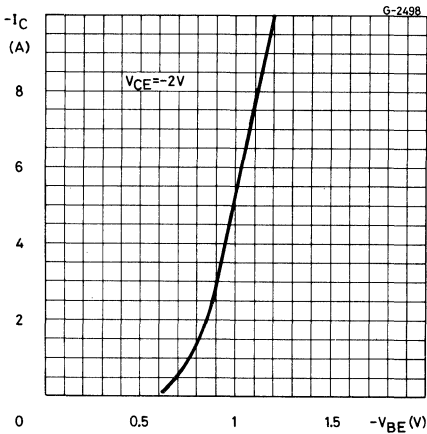

Collector-emitter saturation voltage

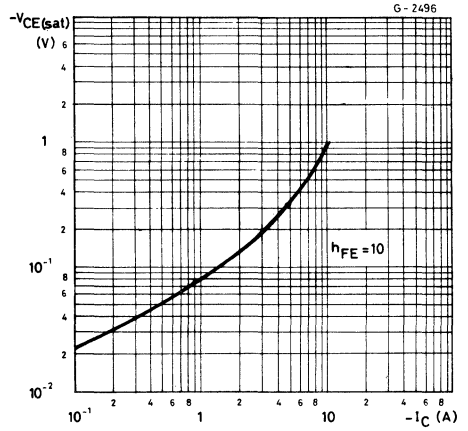



Base-emitter saturation voltage

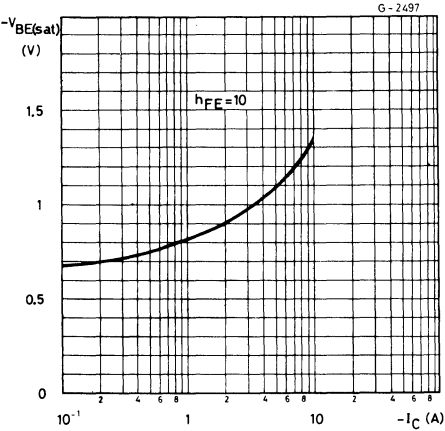

Transition frequency

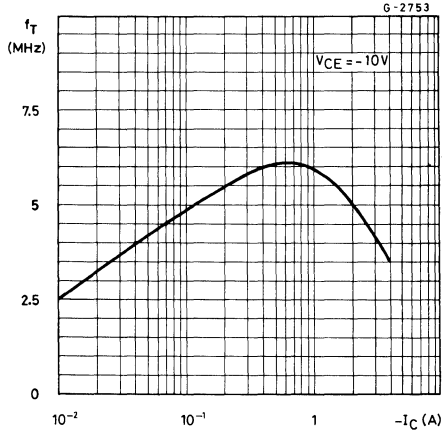

Collector-base capacitance

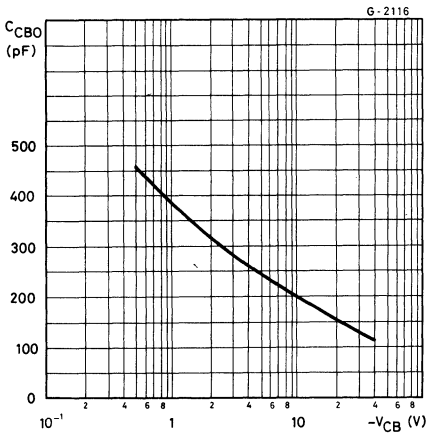

Saturated switching characteristics

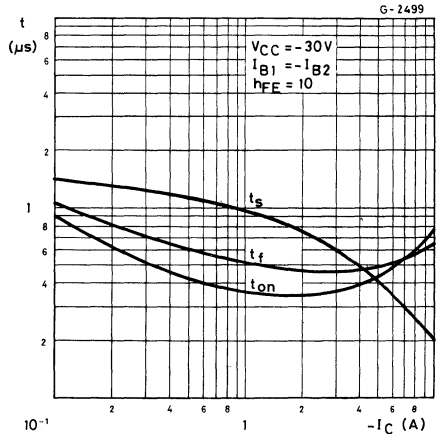



2N4234
2N4235
2N4236

EPITAXIAL PLANAR PNP

MEDIUM POWER GENERAL PURPOSE TRANSISTORS

The 2N4234, 2N4235 and 2N4236 are silicon epitaxial planar PNP transistors in Jedec TO-39 metal case.

They are intended for use in switching and amplifier applications.

The complementary NPN types are the 2N4237, 2N4238 and 2N4239 respectively.

ABSOLUTE MAXIMUM RATINGS

	2N4234	2N4235	2N4236	
V_{CB0}	Collector-base voltage ($I_E = 0$)	-40V	-60V	-80V
V_{CE0}	Collector-emitter voltage ($I_B = 0$)	-40V	-60V	-80V
V_{EB0}	Emitter-base voltage ($I_C = 0$)		-7V	
I_C	Collector current		-3A	
I_B	Base current		-0.2A	
P_{tot}	Total power dissipation at $T_{case} \leq 25^\circ C$ $T_{amb} \leq 25^\circ C$		6W	1W
T_{stg}	Storage temperature		-65 to 200°C	
T_j	Junction temperature		200°	

INTERNAL SCHEMATIC DIAGRAM

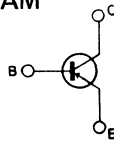

MECHANICAL DATA

Dimensions in mm

Collector connected to case

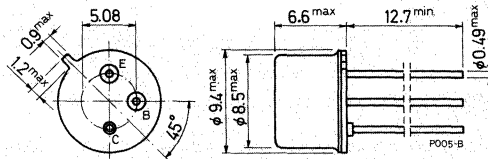

TO-39

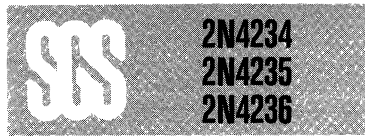

THERMAL DATA

$R_{th\ j-case}$	Thermal resistance junction-case	max	29	°C/W
$R_{th\ j-amb}$	Thermal resistance junction-ambient	max	175	°C/W

ELECTRICAL CHARACTERISTICS ($T_{case} = 25^{\circ}C$ unless otherwise specified)

Parameter	Test conditions	Min.	Typ.	Max.	Unit
I_{CBO}	Collector cutoff current ($I_E = 0$)	for 2N4234 for 2N4235 for 2N4236	$V_{CE} = -40V$ $V_{CE} = -60V$ $V_{CE} = -80V$	-0.1 -0.1 -0.1	mA mA mA
I_{CEV}	Collector cutoff current ($V_{BE} = 1.5$)	for 2N4234 for 2N4235 for 2N4236 $T_{case} = 150^{\circ}C$ for 2N4234 for 2N4235 for 2N4236	$V_{CE} = -40V$ $V_{CE} = -60V$ $V_{CE} = -80V$ $V_{CE} = -30V$ $V_{CE} = -40V$ $V_{CE} = -60V$	-0.1 -0.1 -0.1 -1 -1 -1	mA mA mA mA mA mA
I_{CEO}	Collector cutoff current ($I_B = 0$)	for 2N4234 for 2N4235 for 2N4236	$V_{CE} = -30V$ $V_{CE} = -40V$ $V_{CE} = -60V$	-1 -1 -1	mA mA mA
I_{EBO}	Emitter cutoff current ($I_C = 0$)	$V_{BE} = 7V$		-0.5	mA
$V_{CEO(sus)}$	*Collector-emitter sustaining voltage ($I_B = 0$)	$I_C = -100mA$ for 2N4234 for 2N4235 for 2N4236		-40 -60 -80	V V V



2N4234
2N4235
2N4236

ELECTRICAL CHARACTERISTICS (continued)

Parameter	Test conditions	Min.	Typ.	Max.	Unit
$V_{CE(sat)}$ * Collector-emitter saturation voltage	$I_C = -1A$ $I_B = -100mA$		-0.6		V
$V_{BE(sat)}$ * Base-emitter saturation voltage	$I_C = -1A$ $I_B = -100mA$		-1.5		V
V_{BE} * Base-emitter voltage	$I_C = -0.25A$ $V_{CE} = -1V$		-1.0		V
h_{FE} * DC current gain	$I_C = -100mA$ $V_{CE} = -1V$ $I_C = -250mA$ $V_{CE} = -1V$ $I_C = -500mA$ $V_{CE} = -1V$ $I_C = -1A$ $V_{CE} = -1V$	40 30 20 10		150	— — — —
f_T Transition frequency	$I_C = -100mA$ $V_{CE} = -10V$ $f = 1MHz$	3			MHz
C_{CBO} Collector-base capacitance	$I_E = 0$ $V_{CB} = -10V$ $f = 100KHz$		100		pF
h_{fe} Small signal current gain	$I_C = -50mA$ $V_{CE} = -10V$ $f = 1KHz$	25			—

* Pulsed: pulse duration = 300 μ s, duty cycle \leq 2%

EPITAXIAL PLANAR NPN



HIGH CURRENT, FAST SWITCHING APPLICATIONS

The 2N 4895, 2N 4896 and 2N 4897 are silicon epitaxial planar NPN transistors in Jedec TO-39 metal case.

They are intended for high current, fast switching applications and for power amplifiers.

ABSOLUTE MAXIMUM RATINGS

		2N4895	2N4896	2N4897
V_{CBO}	Collector-base voltage ($I_E = 0$)	120V	120V	150V
V_{CEO}	Collector-emitter voltage ($I_B = 0$)	60V	60V	80V
V_{EBO}	Emitter-base voltage ($I_C = 0$)		6V	
I_C	Collector current		5A	
P_{tot}	Total power dissipation at $T_{amb} \leq 25^\circ C$		1W	
	$T_{case} \leq 25^\circ C$		7W	
	$T_{case} \leq 100^\circ C$		4W	
T_{stg}	Storage temperature		-65 to 200 °C	
T_j	Junction temperature		200 °C	

INTERNAL SCHEMATIC DIAGRAM

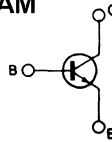

MECHANICAL DATA

Dimensions in mm

Collector connected to case

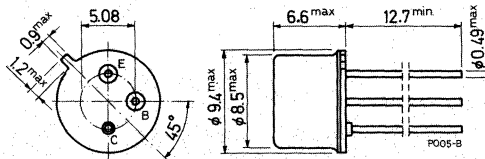

TO-39



2N4895
2N4896
2N4897

THERMAL DATA

$R_{th\ j-case}$	Thermal resistance junction-case	max	25	°C/W
$R_{th\ j-amb}$	Thermal resistance junction-ambient	max	175	°C/W

ELECTRICAL CHARACTERISTICS ($T_{case} = 25^{\circ}C$ unless otherwise specified)

Parameter	Test conditions	Min.	Typ.	Max.	Unit
I_{CES}	Collector cutoff current ($V_{BE} = 0$) for 2N4895 and 2N4896 $V_{CE} = 120V$ $V_{CE} = 60V$ $V_{CE} = 60V$ for 2N4897 $V_{CE} = 150V$ $V_{CE} = 100V$ $V_{CE} = 100V$ $T_{case} = 150^{\circ}C$			1 1 100 1 1 100	mA μA μA mA μA μA
I_{EBO}	Emitter cutoff current ($I_C = 0$) $V_{EB} = 6V$			1	mA
$V_{CEO(sus)}$ *	Collector-emitter sustaining voltage ($I_B = 0$) $I_C = 50mA$ for 2N4895 and 2N4896 for 2N4897	60 80			V V
$V_{CE(sat)}$ *	Collector-emitter saturation voltage $I_C = 5A$ $I_B = 0.5A$			1	V
$V_{BE(sat)}$ *	Base-emitter saturation voltage $I_C = 5A$ $I_B = 0.5A$			1.6	V
h_{FE} *	DC current gain $I_C = 2A$ $V_{CE} = 2V$ for 2N4895 and 2N4897 for 2N4896 $I_C = 2A$ $V_{CE} = 2V$ $T_{case} = -55^{\circ}C$ for 2N4895 and 2N4897 for 2N4896	40 100	120 300		— — — —
f_T	Transition frequency $I_C = 0.5A$ $V_{CE} = 5V$ for 2N4895 and 2N4897 for 2N4896	50 80			MHz MHz
C_{CBO}	Collector-base capacitance $I_E = 0$ $V_{CB} = 10V$ $f = 1MHz$			80	pF
t_{on}	Turn-on time $I_C = 5A$ $V_{CC} = 20V$ $I_{B1} = 0.5A$			0.35	μs
t_s	Storage time $I_C = 5A$ $V_{CC} = 20V$			0.35	μs
t_f	Fall time $I_{B1} = -I_{B2} = 0.5A$			0.3	μs

* Pulsed: pulse duration = 300 μs , duty cycle = 1.5%

Safe operating areas

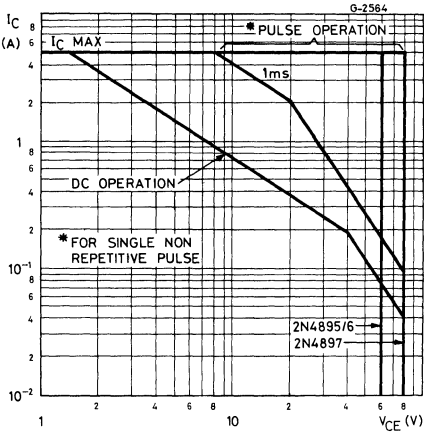

DC current gain

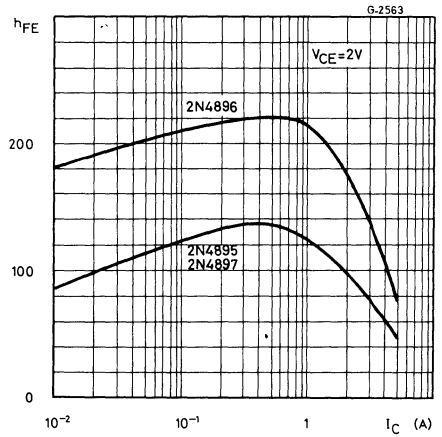

DC transconductance

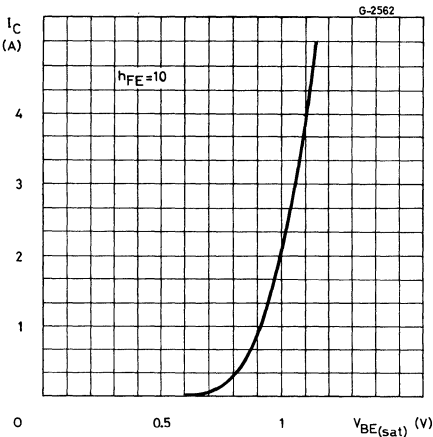

Collector-emitter saturation voltage

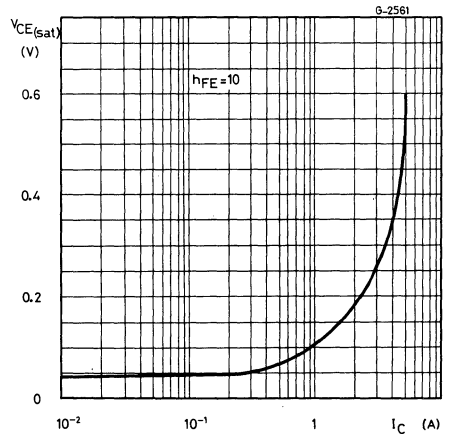

Transition frequency

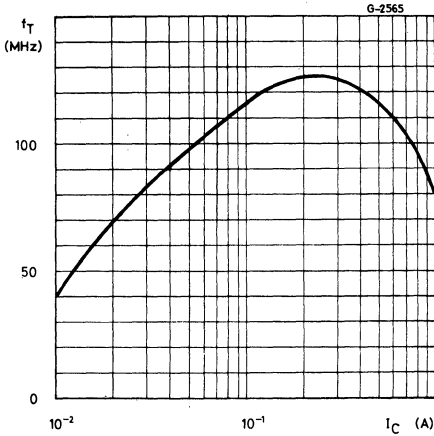

Collector-base capacitance

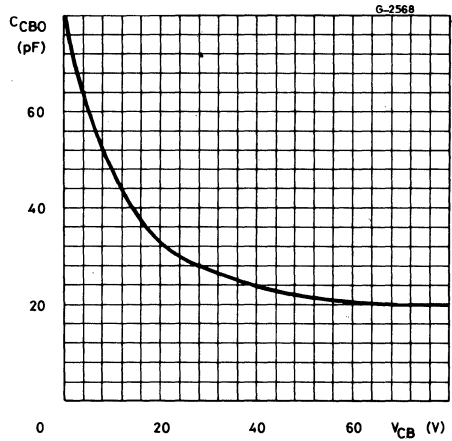

Saturated switching characteristics

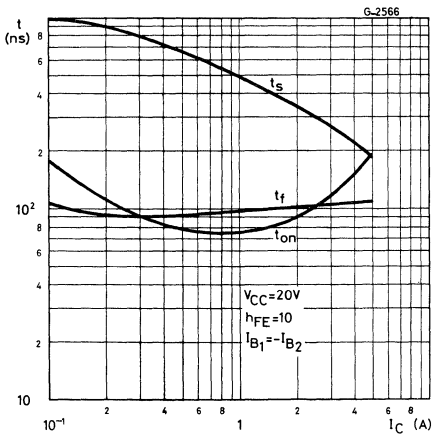

Power rating chart

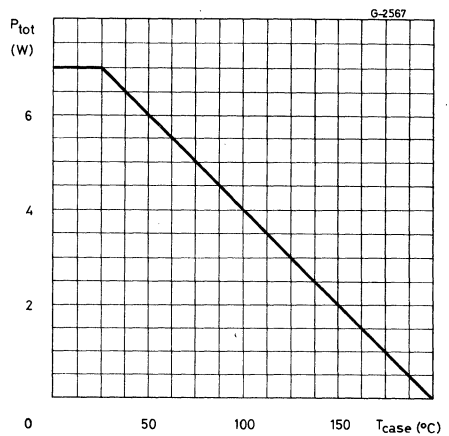



MULTIEPITAXIAL PLANAR NPN

HIGH CURRENT POWER SWITCH

The 2N 5038, 2N 5039 and 2N 6496 are silicon planar multiepitaxial NPN transistors in Jedec TO-3 metal case.

They are especially intended for high current and fast switching applications.

ABSOLUTE MAXIMUM RATINGS

		2N5038	2N5039	2N6496
V_{CBO}	Collector-base voltage ($I_E = 0$)	150V	120V	150V
V_{CEX}	Collector-emitter voltage ($V_{BE} = -1.5V, R_{BE} = 100\Omega$)	150V	120V	150V
V_{CER}	Collector-emitter voltage ($R_{BE} \leq 50\Omega$)	110V	95V	130V
V_{CEO}	Collector-emitter voltage ($I_B = 0$)	90V	75V	110V
V_{EBO}	Emitter-base voltage ($I_C = 0$)	7V	7V	7V
I_C	Collector current	20A	20A	15A
I_{CM}	Collector peak current	30A	30A	—
I_B	Base current		5A	
P_{tot}	Total power dissipation at $T_{case} \leq 25^\circ C$		140W	
T_{stg}	Storage temperature		-65 to 200 °C	
T_j	Junction temperature		200 °C	

INTERNAL SCHEMATIC DIAGRAM

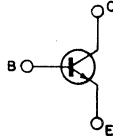

MECHANICAL DATA

Dimensions in mm

Collector connected to case

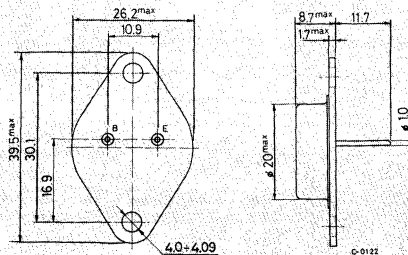

TO-3



THERMAL DATA

$R_{th\ j-case}$	Thermal resistance junction-case	max	1.25 °C/W
------------------	----------------------------------	-----	-----------

ELECTRICAL CHARACTERISTICS ($T_{case} = 25\text{ °C}$ unless otherwise specified)

Parameter	Test conditions	Min.	Typ.	Max.	Unit
I_{CEV} Collector cutoff current ($V_{BE} = -1.5\text{ V}$)	for 2N5038 $V_{CE} = 140\text{ V}$ $V_{CE} = 100\text{ V}$ $T_{case} = 150\text{ °C}$ for 2N5039 $V_{CE} = 110\text{ V}$ $V_{CE} = 85\text{ V}$ $T_{case} = 150\text{ °C}$ for 2N6496 $V_{CE} = 130\text{ V}$ $V_{CE} = 130\text{ V}$ $T_{case} = 150\text{ °C}$			50 10	mA mA
I_{CEO} Collector cutoff current ($I_B = 0$)	for 2N5038 $V_{CE} = 70\text{ V}$ for 2N5039 $V_{CE} = 55\text{ V}$			20 20	mA mA
I_{EBO} Emitter cutoff current ($I_C = 0$)	$V_{EB} = 7\text{ V}$ $V_{EB} = 5\text{ V}$ for 2N5038 for 2N5039			50 5 15	mA mA mA
$V_{CEX(sus)}$ * Collector-emitter sustaining voltage ($V_{BE} = -1.5\text{ V}$, $R_{BE} = 100\Omega$)	$I_C = 200\text{ mA}$ for 2N5038 for 2N5039 for 2N6496			150 120 150	V V V
$V_{CER(sus)}$ * Collector-emitter sustaining voltage ($R_{BE} = 50\Omega$)	$I_C = 200\text{ mA}$ for 2N5038 for 2N5039 for 2N6496			110 95 130	V V V
$V_{CEO(sus)}$ * Collector-emitter sustaining voltage ($I_B = 0$)	$I_C = 200\text{ mA}$ for 2N5038 for 2N5039 for 2N6496			90 75 110	V V V



2N5038
2N5039
2N6496

ELECTRICAL CHARACTERISTICS (continued)

Parameter	Test conditions	Min.	Typ.	Max.	Unit
$V_{CE(sat)}$ * Collector-emitter saturation voltage	for 2N5038				
	$I_C = 12\text{ A}$ $I_B = 1.2\text{ A}$			1	V
	$I_C = 20\text{ A}$ $I_B = 5\text{ A}$			2.5	V
	for 2N5039				
	$I_C = 10\text{ A}$ $I_B = 1\text{ A}$			1	V
	$I_C = 20\text{ A}$ $I_B = 5\text{ A}$			2.5	V
	for 2N6496				
	$I_C = 8\text{ A}$ $I_B = 0.8\text{ A}$			1	V
$V_{BE(sat)}$ * Base-emitter saturation voltage	for 2N5038 and 2N5039				
	$I_C = 20\text{ A}$ $I_B = 5\text{ A}$			3.3	V
	for 2N6496				
	$I_C = 8\text{ A}$ $I_B = 0.8\text{ A}$			2	V
V_{BE} * Base-emitter voltage	for 2N5038				
	$I_C = 12\text{ A}$ $V_{CE} = 5\text{ V}$			1.8	V
	for 2N5039				
	$I_C = 10\text{ A}$ $V_{CE} = 5\text{ V}$			1.8	V
	for 2N6496				
	$I_C = 8\text{ A}$ $V_{CE} = 2\text{ V}$			1.6	V
h_{FE} * DC current gain	for 2N5038				
	$I_C = 2\text{ A}$ $V_{CE} = 5\text{ V}$	50		250	—
	$I_C = 12\text{ A}$ $V_{CE} = 5\text{ V}$	20		100	—
	for 2N5039				
	$I_C = 2\text{ A}$ $V_{CE} = 5\text{ V}$	30		250	—
	$I_C = 10\text{ A}$ $V_{CE} = 5\text{ V}$	20		100	—
	for 2N6496				
	$I_C = 8\text{ A}$ $V_{CE} = 2\text{ V}$	12		100	—
h_{ie} Small signal current gain	$I_C = 2\text{ A}$ $V_{CE} = 10\text{ V}$ $f = 5\text{ MHz}$			12	—
C_{CBO} Collector-base capacitance	$I_E = 0$ $V_{CB} = 10\text{ V}$ $f = 1\text{ MHz}$			300	pF
t_r Rise time	for 2N5038			0.5	μs
t_s Storage time	$I_C = 12\text{ A}$ $V_{CC} = 30\text{ V}$ $I_{B1} = -I_{B2} = 1.2\text{ A}$				
	for 2N5039				
	$I_C = 10\text{ A}$ $V_{CC} = 30\text{ V}$ $I_{B1} = -I_{B2} = 1\text{ A}$			1.5	μs
	for 2N6496				
t_f Fall time	$I_C = 8\text{ A}$ $V_{CC} = 30\text{ V}$ $I_{B1} = -I_{B2} = 0.8\text{ A}$			0.5	μs



2N5038
2N5039
2N6496

ELECTRICAL CHARACTERISTICS (continued)

Parameter	Test conditions	Min. Typ. Max.	Unit
$I_{S/b}^{**}$	Second breakdown collector current $V_{CE} = 28\text{ V}$ $V_{CE} = 45\text{ V}$	5 0.9	A A
$E_{S/b}$	Second breakdown energy $V_{BE} = -4\text{ V}$ $R_{BE} = 20\ \Omega$ $L = 180\ \mu\text{H}$ for 2N5038 for 2N5039 for 2N6496	13 13 5.7	mJ mJ mJ

* Pulsed: pulse duration = 300 μs , duty cycle = 1.5%

** Pulsed: 1 s non repetitive pulse

Safe operating areas
(for **2N5038** and **2N5039**)

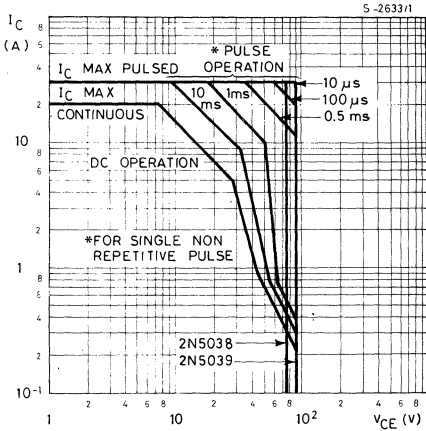

Safe operating areas
(for **2N6496**)

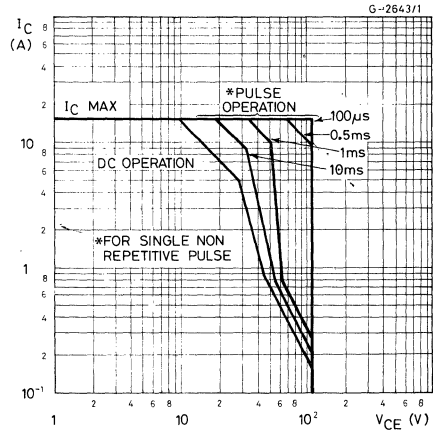

DC current gain

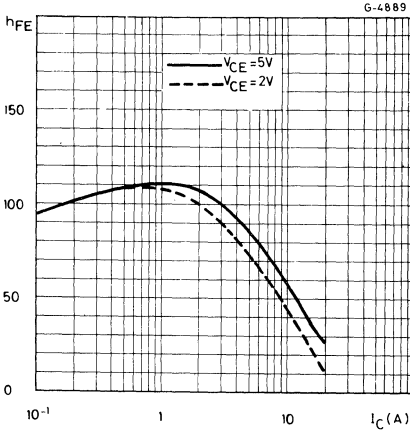

Collector-emitter saturation voltage

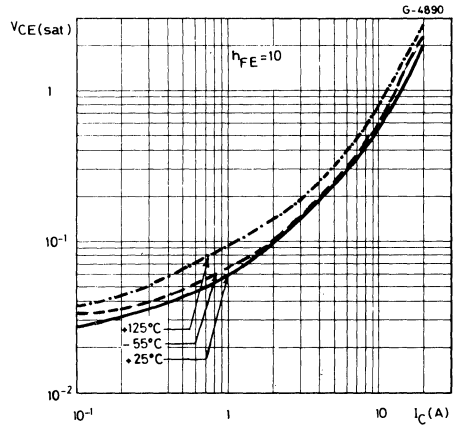

Collector-emitter saturation voltage

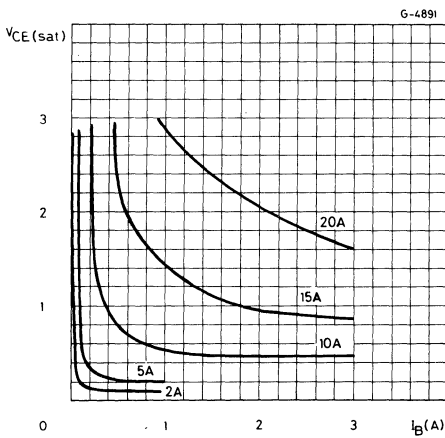

Base-emitter saturation voltage

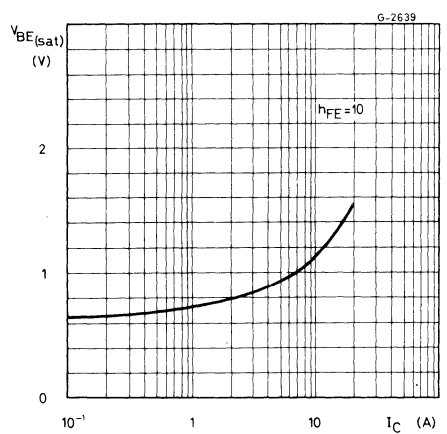



2N5038
2N5039
2N6496

$V_{BE(on)}$ vs. collector current

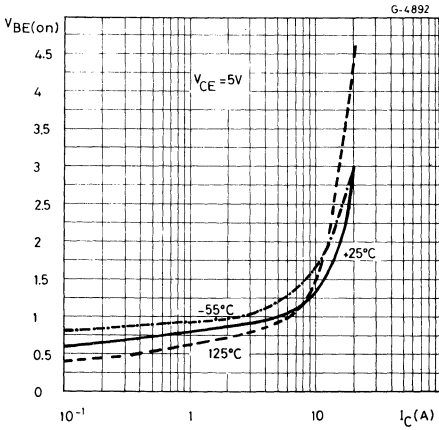

Saturated switching characteristics

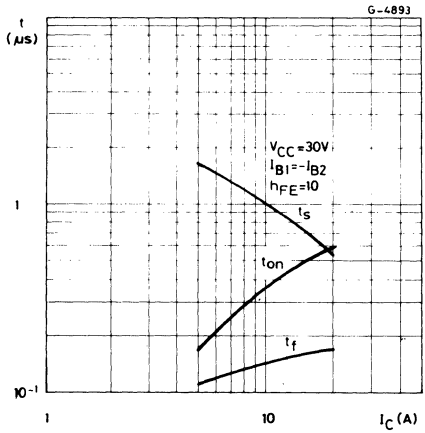

Collector-base capacitance

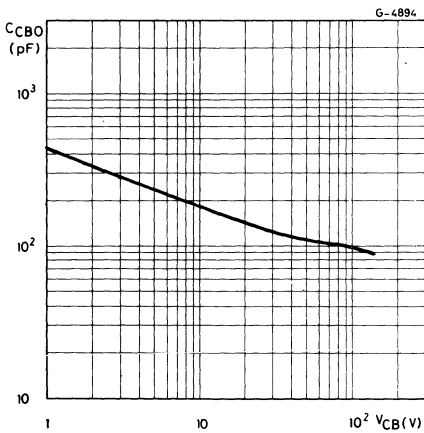

Transition frequency

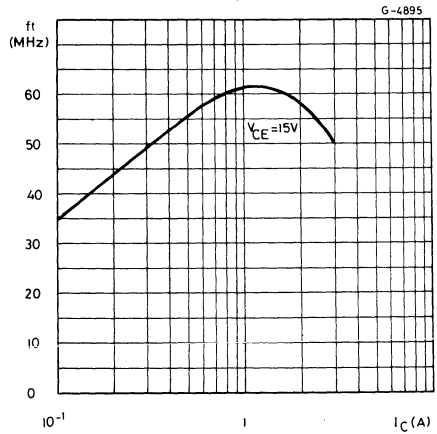



EPITAXIAL PLANAR PNP

HIGH SPEED MEDIUM VOLTAGE SWITCHES

The 2N5151 and 2N5153 are silicon epitaxial planar PNP transistors in Jedec TO-39 metal case intended for use in switching applications. The complementary NPN types are the 2N5152 and 2N5154 respectively.

ABSOLUTE MAXIMUM RATINGS

		2N5151	2N5153
V_{CBO}	Collector-base voltage ($I_E = 0$)		-100V
V_{CEO}	Collector-emitter voltage ($I_B = 0$)		-80V
V_{EBO}	Emitter-base voltage ($I_C = 0$)		-5.5V
I_C	Collector current		-5A
I_{CM}	Collector peak current		-10A
I_B	Base current		-2.5A
P_{tot}	Total power dissipation at	$T_{case} \leq 50^\circ C$	10W
		$T_{case} \leq 100^\circ C$	6.7W
		$T_{amb} \leq 25^\circ C$	1W
T_{stg}	Storage temperature		-65 to 200°C
T_j	Junction temperature		200°C

INTERNAL SCHEMATIC DIAGRAM

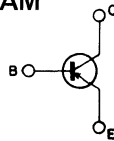

MECHANICAL DATA

Dimensions in mm

Collector connected to case

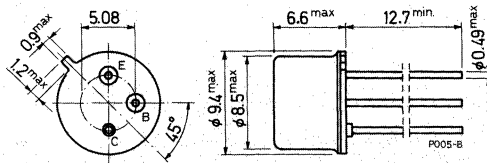

TO-39



2N5151
2N5153

THERMAL DATA

$R_{th\ j-case}$	Thermal resistance junction-case	max	15	°C/W
$R_{th\ j-amb}$	Thermal resistance junction-ambient	max	175	°C/W

ELECTRICAL CHARACTERISTICS ($T_{case} = 25^{\circ}C$ unless otherwise specified)

Parameter	Test conditions	Min.	Typ.	Max.	Unit
I_{CES}	Collector cutoff current ($V_{BE} = 0$)	$V_{CE} = -60V$ $V_{CE} = -100V$		-1 -1	μA mA
I_{CEV}	Collector cutoff current ($V_{BE} = 2V$)	$V_{CE} = -60V$ $T_{case} = 150^{\circ}C$		-500	μA
I_{CEO}	Collector cutoff current ($I_B = 0$)	$V_{CE} = -40V$		-50	μA
I_{EBO}	Emitter cutoff current ($I_C = 0$)	$V_{EB} = -4V$ $V_{EB} = -5.5V$		-1 -1	μA mA
$V_{CEO(sus)}$ *	Collector-emitter sustaining voltage ($I_B = 0$)	$I_C = -100mA$		-80	V
$V_{CE(sat)}$ *	Collector-emitter saturation voltage	$I_C = -2.5A$ $I_B = -250mA$ $I_C = -5A$ $I_B = -500mA$		-0.75 -1.5	V V
$V_{BE(sat)}$ *	Base-emitter saturation voltage	$I_C = -2.5A$ $I_B = -250mA$ $I_C = -5A$ $I_B = -500mA$		-1.45 -2.2	V V
V_{BE} *	Base-emitter voltage	$I_C = -2.5A$ $V_{CE} = -5V$		-1.45	V
h_{FE} *	DC current gain	for 2N5151 $I_C = -50mA$ $V_{CE} = -5V$ $I_C = -2.5A$ $V_{CE} = -5V$ $I_C = -5A$ $V_{CE} = -5V$ $T_{case} = -55^{\circ}C$ $I_C = -2.5A$ $V_{CE} = -5V$ for 2N5153 $I_C = -50mA$ $V_{CE} = -5V$ $I_C = -2.5A$ $V_{CE} = -5V$ $I_C = -5A$ $V_{CE} = -5V$ $T_{case} = -55^{\circ}C$ $I_C = -2.5A$ $V_{CE} = -5V$		20 30 20 15 50 70 40 35	— — — — — 200 — —

ELECTRICAL CHARACTERISTICS (continued)

Parameter		Test conditions		Min. Typ. Max.	Unit
C_{CBO}	Collector-base capacitance	$I_E = 0$ $f = 1\text{MHz}$	$V_{CB} = -10\text{V}$	250	pF
h_{fe}	Small signal current gain	$I_C = -0.1\text{A}$ $f = 1\text{KHz}$ for 2N5151 for 2N5153	$V_{CE} = -5\text{V}$	20	—
			$V_{CE} = -5\text{V}$	50	—
t_{on}	Turn on time	$I_C = -5\text{A}$ $V_{CC} = 30\text{V}$	$I_{B1} = -0.5\text{A}$	0.5	μs
			$I_{B1} = -I_{B2} = 0.5\text{A}$	1.3	μs
t_{off}	Turn off time	$I_C = -5\text{A}$ $V_{CC} = 30\text{V}$	$I_{B1} = -I_{B2} = 0.5\text{A}$	1.3	μs

* Pulsed: pulse duration = $300\mu\text{s}$, duty cycle $\leq 2\%$.



2N5152
2N5154

EPITAXIAL PLANAR NPN

HIGH SPEED MEDIUM VOLTAGE SWITCHES

The 2N5152 and 2N5154 are silicon epitaxial planar NPN transistors in Jedec TO-39 metal case intended for use in switching applications. The complementary PNP types are the 2N5151 and 2N5153 respectively.

ABSOLUTE MAXIMUM RATINGS

		2N5152	2N5154
V_{CB0}	Collector-base voltage ($I_E = 0$)		100V
V_{CE0}	Collector-emitter voltage ($I_B = 0$)		80V
V_{EB0}	Emitter-base voltage ($I_C = 0$)		6V
I_C	Collector current		2A
I_{CM}	Collector peak current		10A
I_B	Base current		1A
P_{tot}	Total power dissipation at $T_{case} \leq 50^\circ C$		10W
	$T_{case} \leq 100^\circ C$		6.7W
	$T_{amb} \leq 25^\circ C$		1W
T_{stg}	Storage temperature		-65 to 200°C
T_j	Junction temperature		200°C

INTERNAL SCHEMATIC DIAGRAM

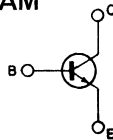

MECHANICAL DATA

Dimensions in mm

Collector connected to case

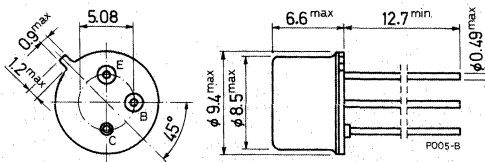

TO-39

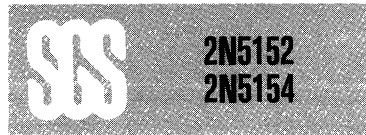

THERMAL DATA

$R_{th\ j-case}$	Thermal resistance junction-case	max	15	°C/W
$R_{th\ j-amb}$	Thermal resistance junction-ambient	max	175	°C/W

ELECTRICAL CHARACTERISTICS ($T_{case} = 25^{\circ}C$ unless otherwise specified)

Parameter	Test conditions	Min.	Typ.	Max.	Unit
I_{CES}	Collector cutoff current ($V_{BE} = 0$)	$V_{CE} = 60V$ $V_{CE} = 100V$		1 1	μA mA
I_{CEV}	Collector cutoff current ($V_{BE} = -2V$)	$V_{CE} = 60V$ $T_{case} = 150^{\circ}C$		500	μA
I_{CEO}	Collector cutoff current ($I_B = 0$)	$V_{CE} = 40V$		50	μA
I_{EBO}	Emitter cutoff current ($I_C = 0$)	$V_{EB} = 5V$ $V_{EB} = 6V$		1 1	μA mA
$V_{CEO(sus)}$ *	Collector-emitter sustaining voltage ($I_B = 0$)	$I_C = 100mA$		80	V
$V_{CE(sat)}$ *	Collector-emitter saturation voltage	$I_C = 2.5A$ $I_B = 250mA$ $I_C = 5A$ $I_B = 500mA$		0.75 1.5	V V
$V_{BE(sat)}$ *	Base-emitter saturation voltage	$I_C = 2.5A$ $I_B = 250mA$ $I_C = 5A$ $I_B = 500mA$		1.45 2.2	V V
V_{BE} *	Base-emitter voltage	$I_C = 2.5A$ $V_{CE} = 5V$		1.45	V
h_{FE} *	DC current gain	for 2N5152 $I_C = 50mA$ $V_{CE} = 5V$ $I_C = 2.5A$ $V_{CE} = 5V$ $I_C = 5A$ $V_{CE} = 5V$ $T_{case} = -55^{\circ}C$ $I_C = 2.5A$ $V_{CE} = 5V$ for 2N5154 $I_C = 50mA$ $V_{CE} = 5V$ $I_C = 2.5A$ $V_{CE} = 5V$ $I_C = 5A$ $V_{CE} = 5V$ $T_{case} = -55^{\circ}C$ $I_C = 2.5A$ $V_{CE} = 5V$		20 30 20 15 50 70 40 35	— — — — — 200 — — —



2N5152
2N5154

ELECTRICAL CHARACTERISTICS (continued)

Parameter		Test conditions		Min. Typ. Max.	Unit
C_{CBO}	Collector-base capacitance	$I_E = 0$ $f = 1\text{MHz}$	$V_{CB} = 10\text{V}$	250	μF
h_{fe}	Small signal current gain	$I_C = 0.1\text{A}$ $f = 1\text{KHz}$ for 2N5152 for 2N5154 $I_C = 0.5\text{A}$ $f = 20\text{MHz}$ for 2N5152 for 2N5154	$V_{CE} = 5\text{V}$	20	—
			$V_{CE} = 5\text{V}$	50	—
t_{on}	Turn on time	$I_C = 5\text{A}$ $V_{CC} = 30\text{V}$	$I_{B1} = 0.5\text{A}$	0.5	μs
t_{off}	Turn off time	$I_C = 5\text{A}$ $V_{CC} = 30\text{V}$	$I_{B1} = -I_{B2} = 0.5\text{A}$	1.3	μs

* Pulsed: pulse duration = $300\mu\text{s}$, duty cycle $\leq 2\%$.

EPITAXIAL-BASE NPN



MEDIUM POWER LINEAR AND SWITCHING APPLICATIONS

The 2N 5190, 2N 5191, 2N 5192 are silicon epitaxial-base NPN power transistors in Jedec TO-126 plastic package, intended for use in medium power linear and switching applications.

The complementary PNP types are the 2N 5193, 2N 5194 and 2N 5195 respectively.

ABSOLUTE MAXIMUM RATINGS

		2N5190	2N5191	2N5192
V_{CBO}	Collector-base voltage ($I_E = 0$)	40V	60V	80V
V_{CEO}	Collector-emitter voltage ($I_B = 0$)	40V	60V	80V
V_{EBO}	Emitter-base voltage ($I_C = 0$)		5V	
I_C	Collector current		4A	
I_{CM}	Collector peak current ($t \leq 10$ ms)		7A	
I_B	Base current		1A	
P_{tot}	Total power dissipation at $T_{case} \leq 25^\circ C$		40W	
T_{stg}	Storage temperature		-65 to $150^\circ C$	
T_j	Junction temperature		$150^\circ C$	

INTERNAL SCHEMATIC DIAGRAM

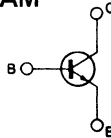

MECHANICAL DATA

Dimensions in mm

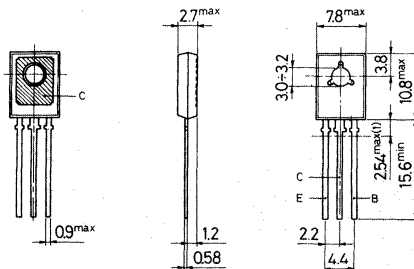

(1) Within this region the cross-section of the leads is uncontrolled

PG32

TO-126 (SOT-32)



2N5190
2N5191
2N5192

THERMAL DATA

$R_{th\ j-case}$	Thermal resistance junction-case	max	3.12	°C/W
$R_{th\ j-amb}$	Thermal resistance junction-ambient	max	100	°C/W

ELECTRICAL CHARACTERISTICS ($T_{case} = 25^{\circ}C$ unless otherwise specified)

Parameter	Test conditions	Min.	Typ.	Max.	Unit
I_{CBO}	Collector cutoff current ($I_E = 0$)	for 2N5190 for 2N5191 for 2N5192	$V_{CB} = 40V$ $V_{CB} = 60V$ $V_{CB} = 80V$	100 100 100	μA μA μA
I_{CEX}	Collector cutoff current ($V_{EB} = 1.5V$)	for 2N5190 for 2N5191 for 2N5192 $T_{case} = 125^{\circ}C$ for 2N5190 for 2N5191 for 2N5192	$V_{CE} = 40V$ $V_{CE} = 60V$ $V_{CE} = 80V$ $V_{CE} = 40V$ $V_{CE} = 60V$ $V_{CE} = 80V$	100 100 100 2 2 2	μA μA μA mA mA mA
I_{CEO}	Collector cutoff current ($I_B = 0$)	for 2N5190 for 2N5191 for 2N5192	$V_{CE} = 40V$ $V_{CE} = 60V$ $V_{CE} = 80V$	1 1 1	mA mA mA
I_{EBO}	Emitter cutoff current ($I_C = 0$)	$V_{EB} = 5V$		1	mA
$V_{CEO(sus)}^*$	Collector-emitter sustaining voltage ($I_B = 0$)	$I_C = 100mA$	for 2N5190 for 2N5191 for 2N5192	40 60 80	V V V
$V_{CE(sat)}^*$	Collector-emitter saturation voltage	$I_C = 1.5A$ $I_C = 4A$	$I_B = 0.15A$ $I_B = 1A$	0.6 1.4	V V
V_{BE}^*	Base-emitter voltage	$I_C = 1.5A$	$V_{CE} = 2V$	1.2	V
h_{FE}^*	DC current gain	$I_C = 1.5A$ $I_C = 4A$	$V_{CE} = 2V$ for 2N5190 for 2N5191 for 2N5192 $V_{CE} = 2V$ for 2N5190 for 2N5191 for 2N5192	25 100 25 100 20 80 10 10 7	— — — — — — — — —
f_T	Transition frequency	$I_C = 1A$	$V_{CE} = 10V$	2	MHz

* Pulsed: pulse duration = 300 μs , duty cycle = 1.5%

Safe operating areas

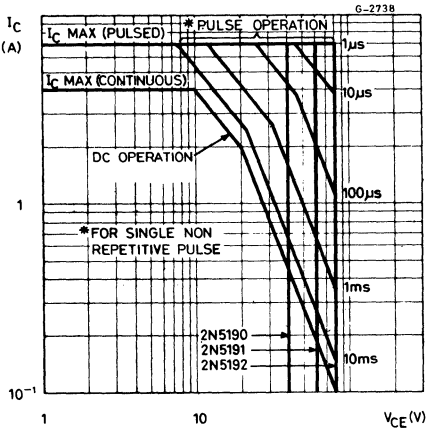

DC current gain

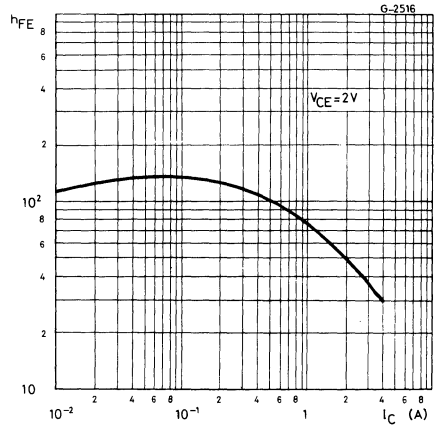

Collector-emitter saturation voltage

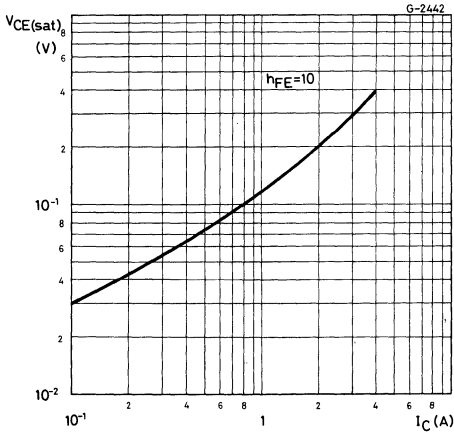

Base-emitter saturation voltage

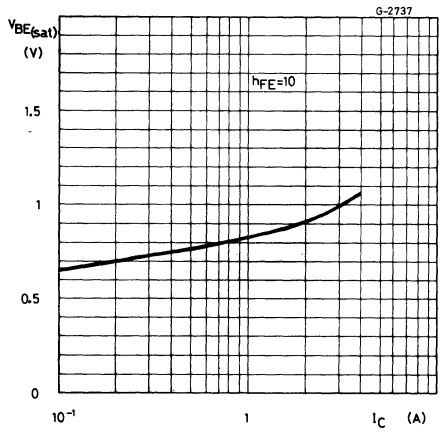

Transition frequency

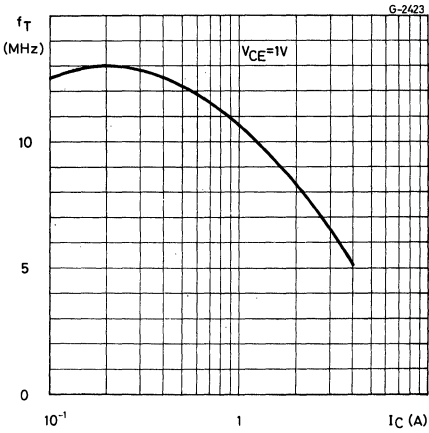

Collector-base capacitance

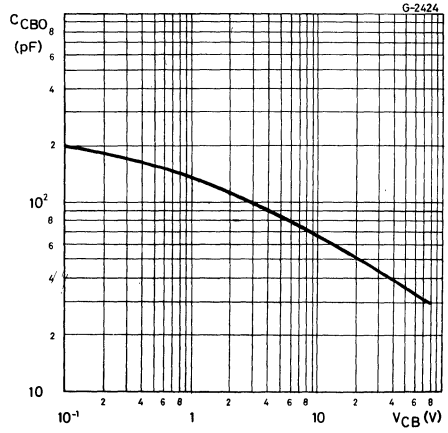

Saturated switching characteristics

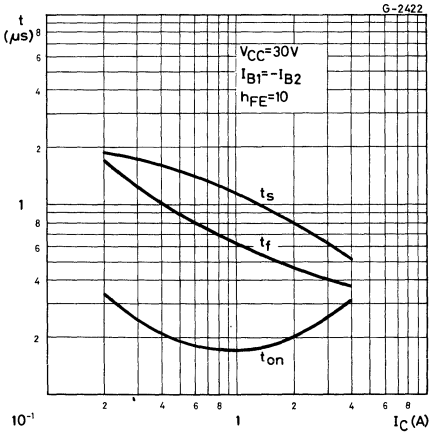

Power rating chart

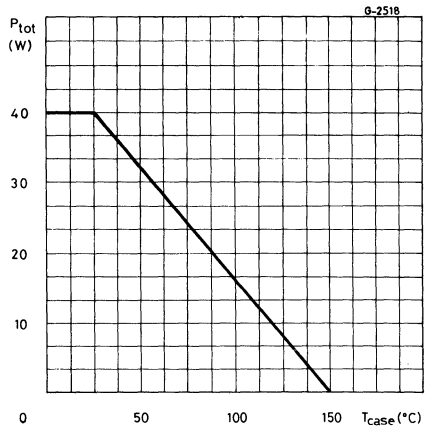



EPITAXIAL-BASE PNP

MEDIUM POWER LINEAR AND SWITCHING APPLICATIONS

The 2N 5193, 2N 5194, 2N 5195 are silicon epitaxial-base PNP power transistors in Jedec TO-126 plastic package, intended for use in medium power linear and switching applications.

The complementary NPN types are the 2N 5190, 2N 5191, 2N 5192 respectively.

ABSOLUTE MAXIMUM RATINGS

		2N5193	2N5194	2N5195
V_{CBO}	Collector-base voltage ($I_E = 0$)	-40V	-60V	-80V
V_{CEO}	Collector-emitter voltage ($I_B = 0$)	-40V	-60V	-80V
V_{EBO}	Emitter-base voltage ($I_C = 0$)		-5V	
I_C	Collector current		-4A	
I_{CM}	Collector peak current ($t \leq 10$ ms)		-7A	
I_B	Base current		-1A	
P_{tot}	Total power dissipation at $T_{case} \leq 25^\circ C$		40W	
T_{stg}	Storage temperature		-65 to 150°C	
T_j	Junction temperature		150°C	

INTERNAL SCHEMATIC DIAGRAM

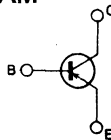

MECHANICAL DATA

Dimensions in mm

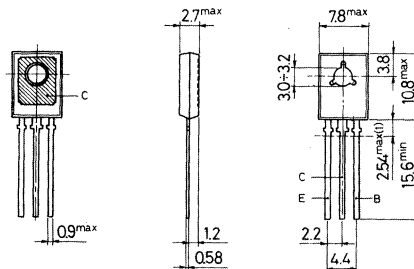

(1) Within this region the cross-section of the leads is uncontrolled

P032

TO-126 (SOT-32)

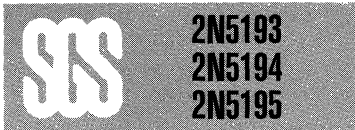

THERMAL DATA

$R_{th\ j-case}$	Thermal resistance junction-case	max	3.12	°C/W
$R_{th\ j-amb}$	Thermal resistance junction-ambient	max	100	°C/W

ELECTRICAL CHARACTERISTICS ($T_{case} = 25^{\circ}C$ unless otherwise specified)

Parameter	Test conditions	Min.	Typ.	Max.	Unit	
I_{CBO} Collector cutoff current ($I_E = 0$)	for 2N5193	$V_{CB} = -40V$		-100	μA	
	for 2N5194	$V_{CB} = -60V$		-100	μA	
	for 2N5195	$V_{CB} = -80V$		-100	μA	
I_{CEX} Collector cutoff current ($V_{EB} = 1.5$)	for 2N5193	$V_{CE} = -40V$		-100	μA	
	for 2N5194	$V_{CE} = -60V$		-100	μA	
	for 2N5195	$V_{CE} = -80V$		-100	μA	
	$T_{case} = 125^{\circ}C$					
	for 2N5193	$V_{CE} = -40V$		-2	mA	
for 2N5194	$V_{CE} = -60V$		-2	mA		
for 2N5195	$V_{CE} = -80V$		-2	mA		
I_{CEO} Collector cutoff current ($I_B = 0$)	for 2N5193	$V_{CE} = -40V$		-1	mA	
	for 2N5194	$V_{CE} = -60V$		-1	mA	
	for 2N5195	$V_{CE} = -80V$		-1	mA	
I_{EBO} Emitter cutoff current ($I_C = 0$)	$V_{EB} = -5V$			-1	mA	
$V_{CEO(sus)}^*$ Collector-emitter sustaining voltage ($I_B = 0$)	$I_C = -100mA$	for 2N5193	-40		V	
		for 2N5194	-60		V	
		for 2N5195	-80		V	
$V_{CE(sat)}^*$ Collector-emitter saturation voltage	$I_C = -1.5A$	$I_B = -0.15A$		-0.6	V	
	$I_C = -4A$	$I_B = -1A$		-1.2	V	
V_{BE}^* Base-emitter voltage	$I_C = -1.5A$	$V_{CE} = -2V$		-1.2	V	
h_{FE}^* DC current gain	$I_C = -1.5A$	$V_{CE} = -2V$	for 2N5193	25	100	—
			for 2N5194	25	100	—
			for 2N5195	20	80	—
	$I_C = -4A$	$V_{CE} = -2V$	for 2N5193	10		—
			for 2N5194	10		—
			for 2N5195	7		—
f_T Transition frequency	$I_C = -1A$	$V_{CE} = -10V$		2	MHz	

* Pulsed: pulse duration = 300 μs , duty cycle = 1.5%

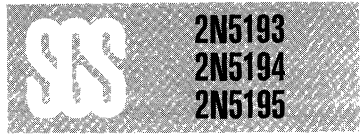

Safe operating areas

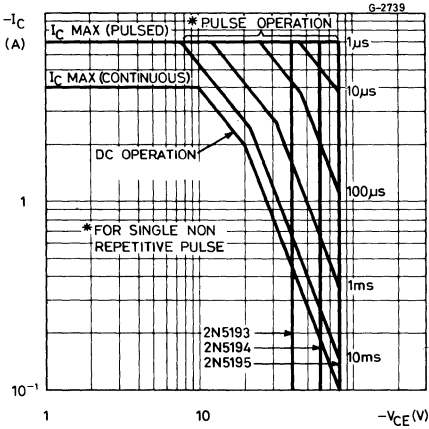

DC current gain

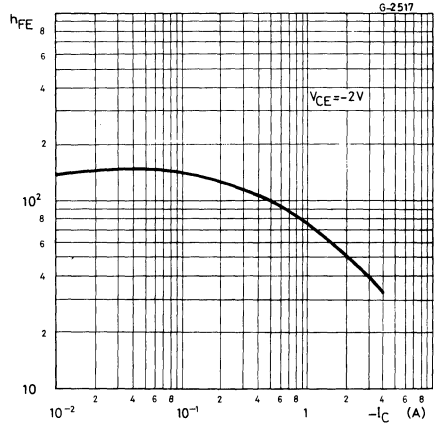

Collector-emitter saturation voltage

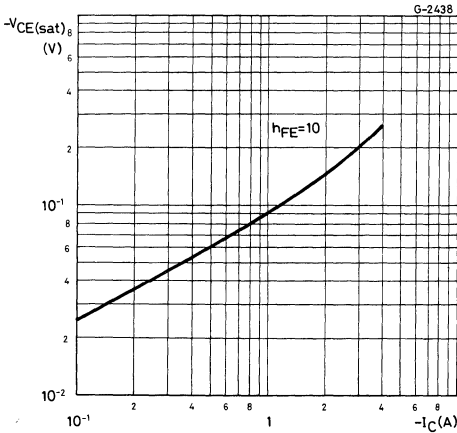

Base-emitter saturation voltage

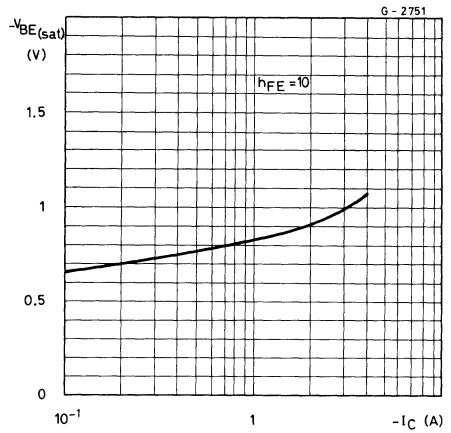

Transition frequency

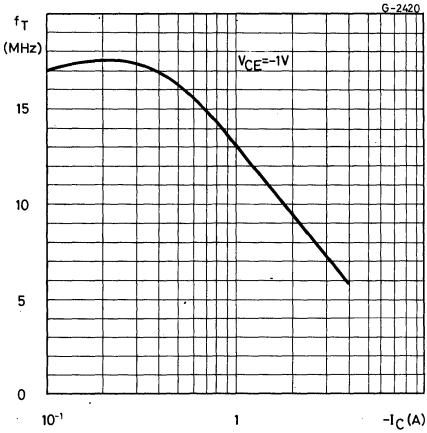

Collector-base capacitance

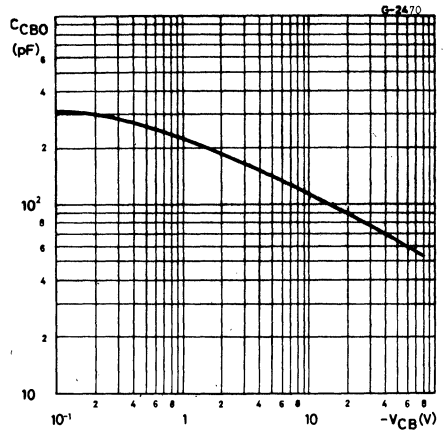

Saturated switching characteristics

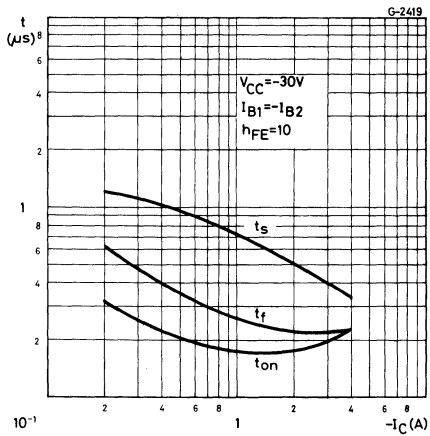

Power rating chart

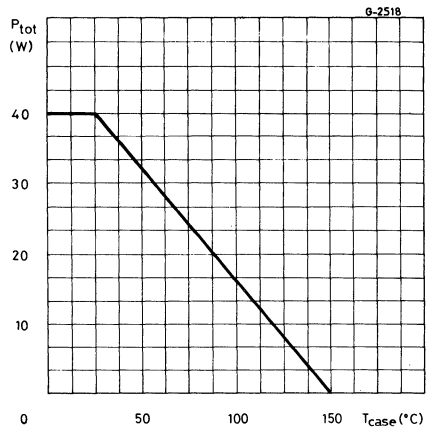

EPITAXIAL PLANAR NPN



HIGH CURRENT FAST SWITCHING APPLICATIONS

The 2N 5336, 2N 5337, 2N 5338 and 2N 5339 are silicon epitaxial planar NPN transistors in Jeduc TO-39 metal case. They are intended for high current switching applications up to 5A.

ABSOLUTE MAXIMUM RATINGS

		2N5336 2N5337	2N5338 2N5339
V_{CBO}	Collector-base voltage ($I_E = 0$)	80V	100V
V_{CEO}	Collector-emitter voltage ($I_B = 0$)	80V	100V
V_{EBO}	Emitter-base voltage ($I_C = 0$)		6V
I_C	Collector current		5A
I_{CM}	Collector peak current		7A
I_B	Base current		1A
P_{tot}	Total power dissipation at $T_{amb} \leq 25^\circ C$ $T_{case} \leq 25^\circ C$		1W 6W
T_{stg}	Storage temperature	-65 to 200 °C	
T_j	Junction temperature	200 °C	

INTERNAL SCHEMATIC DIAGRAM

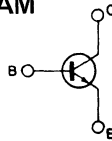

MECHANICAL DATA

Dimensions in mm

Collector connected to case

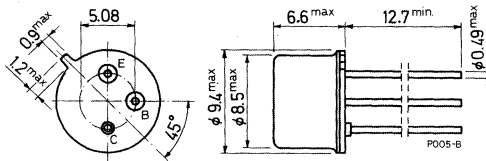

TO-39



THERMAL DATA

$R_{th\ j-case}$	Thermal resistance junction-case	max	29.2	°C/W
$R_{th\ j-amb}$	Thermal resistance junction-ambient	max	175	°C/W

ELECTRICAL CHARACTERISTICS ($T_{case} = 25^{\circ}C$ unless otherwise specified)

Parameter	Test conditions	Min.	Typ.	Max.	Unit
I_{CBO}	Collector cutoff current ($I_E = 0$) for 2N5336 and 2N5337 $V_{CB} = 80\ V$ for 2N5338 and 2N5339 $V_{CB} = 100\ V$			10	μA
I_{CEO}	Collector cutoff current ($I_B = 0$) for 2N5336 and 2N5337 $V_{CE} = 75\ V$ for 2N5338 and 2N5339 $V_{CE} = 90\ V$			100	μA
I_{CEX}	Collector cutoff current ($V_{BE} = -1.5\ V$) for 2N5336 and 2N5337 $V_{CE} = 75\ V$ $V_{CE} = 75\ V$ $T_{case} = 150^{\circ}C$ for 2N5338 and 2N5339 $V_{CE} = 90\ V$ $V_{CE} = 90\ V$ $T_{case} = 150^{\circ}C$			10 1	μA mA
$V_{CEO(sus)}^*$	Collector-emitter sustaining voltage ($I_B = 0$) $I_C = 50\ mA$ for 2N5336 and 2N5337 for 2N5338 and 2N5339	80		100	V
$V_{CE(sat)}^*$	Collector-emitter saturation voltage $I_C = 2\ A$ $I_B = 0.2\ A$ $I_C = 5\ A$ $I_B = 0.5\ A$			0.7 1.2	V
$V_{BE(sat)}^*$	Base-emitter saturation voltage $I_C = 2\ A$ $I_B = 0.2\ A$ $I_C = 5\ A$ $I_B = 0.5\ A$			1.2 1.8	V
h_{FE}^*	DC current gain $I_C = 0.5\ A$ $V_{CE} = 2\ V$ for 2N5336 and 2N5338 for 2N5337 and 2N5339 $I_C = 2\ A$ $V_{CE} = 2\ V$ for 2N5336 and 2N5338 for 2N5337 and 2N5339 $I_C = 5\ A$ $V_{CE} = 2\ V$ for 2N5336 and 2N5338 for 2N5337 and 2N5339	30 60		120 240	— —
		30 60			— —
		20 40			— —



ELECTRICAL CHARACTERISTICS (continued)

Parameter	Test conditions	Min. Typ. Max.	Unit
f_T	Transition frequency $I_C = 0.5A$ $V_{CE} = 10V$	30	MHz
C_{CBO}	Collector-base capacitance $V_{CB} = 10V$ $I_E = 0$ $f = 0.1\text{ MHz}$	250	pF
t_{on}	Turn-on time $I_C = 2A$ $V_{CC} = 40V$ $I_{B1} = 0.2A$	200	ns
t_s	Storage time $I_C = 2A$ $V_{CC} = 40V$	2	μs
t_f	Fall time $I_{B1} = -I_{B2} = 0.2A$	200	ns

* Pulsed: pulse duration = 300 μs , duty cycle = 1.5%

Safe operating areas

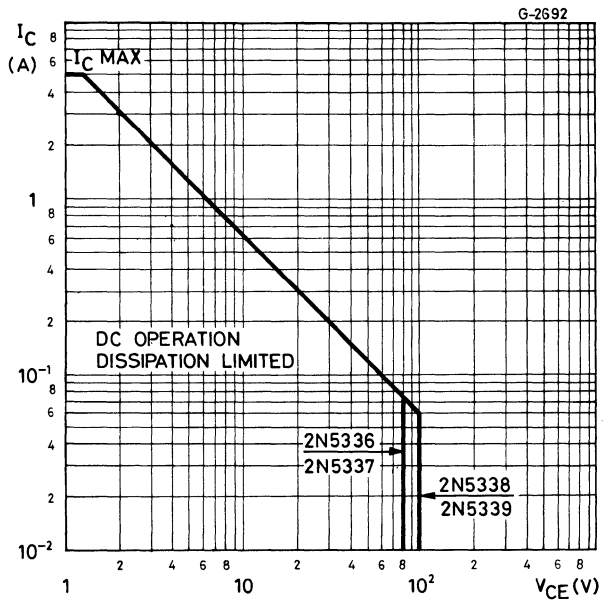



DC current gain

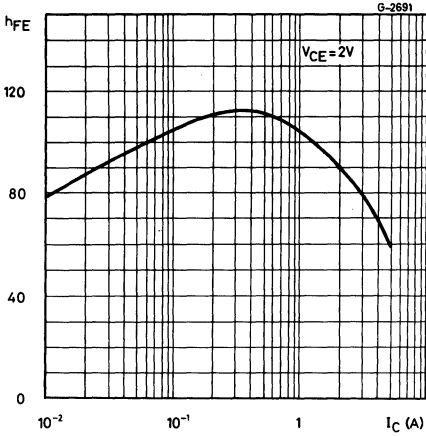

Collector-emitter saturation voltage

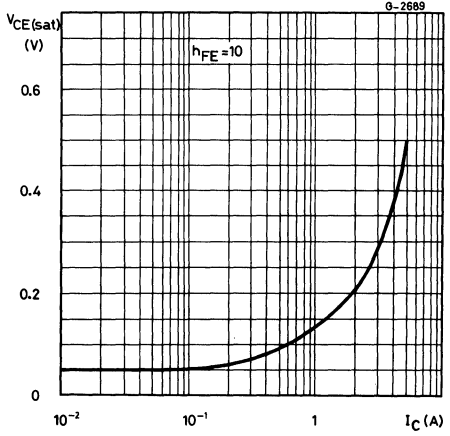

Base-emitter saturation voltage

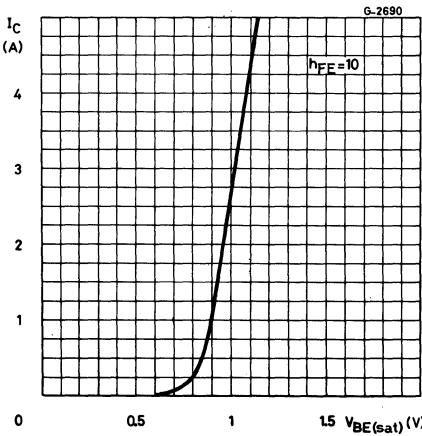

Collector-base capacitance

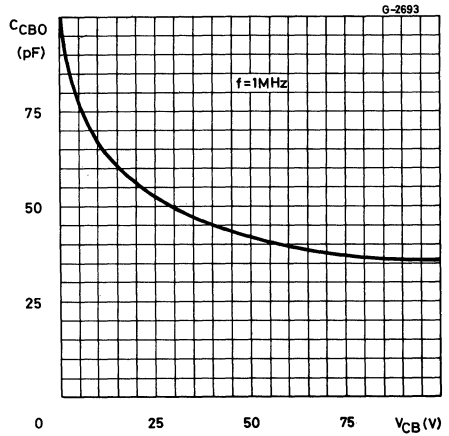



Saturated switching characteristics

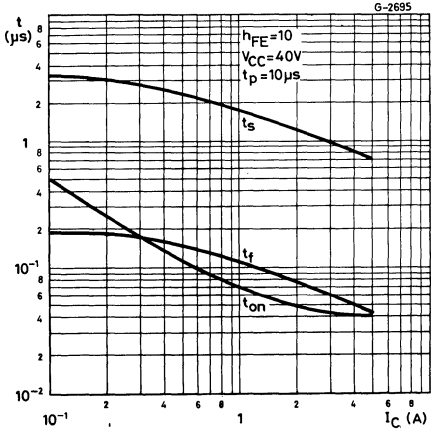

Power rating chart

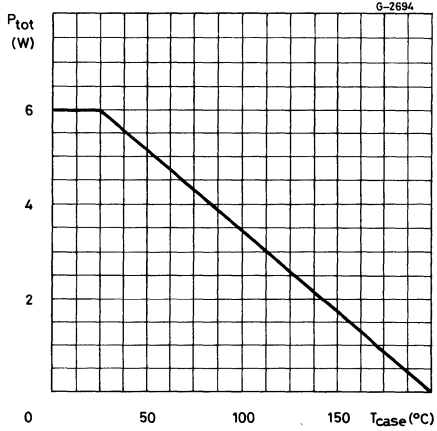

Switching time test circuit

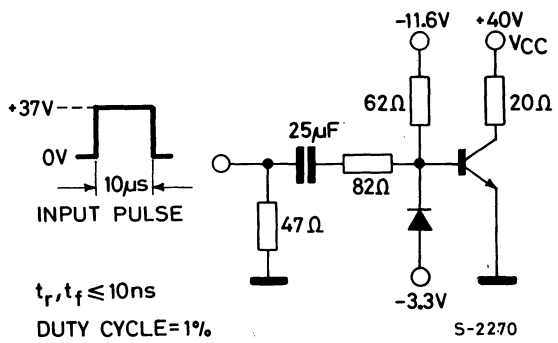



2N5415
2N5416

EPITAXIAL PLANAR PNP

HIGH VOLTAGE TRANSISTORS

The 2N5415, 2N5416 are high voltage silicon epitaxial planar transistors designed for use in consumer and industrial line-operated applications. These devices are particularly suited as drivers in high-voltage low current inverters, switching and series regulators.

ABSOLUTE MAXIMUM RATINGS

		2N5415	2N5416
V_{CBO}	Collector-base voltage ($I_E = 0$)	-200V	-350V
V_{CEO}	Collector-emitter voltage ($I_B = 0$)	-200V	-300V
V_{EBO}	Emitter-base voltage ($I_C = 0$)	-4V	-6V
I_C	Collector current		-1A
I_B	Base current		-0.5A
P_{tot}	Total power dissipation at $T_{case} \leq 25^\circ C$ $T_{amb} \leq 50^\circ C$		10W 1W
T_{stg}	Storage temperature		-65 to 200°C
T_j	Junction temperature		200°C

INTERNAL SCHEMATIC DIAGRAM

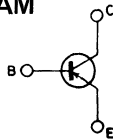

MECHANICAL DATA

Dimensions in mm

Collector connected to case

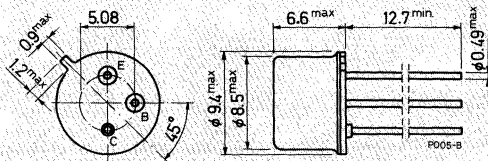

TO-39



THERMAL DATA

$R_{th\ j-case}$	Thermal resistance junction-case	max	17.5 °C/W
$R_{th\ j-amb}$	Thermal resistance junction-ambient	max	150 °C/W

ELECTRICAL CHARACTERISTICS ($T_{case} = 25^{\circ}C$ unless otherwise specified)

Parameter	Test conditions	Min. Typ. Max.	Unit
I_{CBO} Collector cutoff current ($I_E = 0$)	for 2N5415 $V_{CB} = -175V$ for 2N5416 $V_{CB} = -280V$	-50 -50	μA μA
I_{CEO} Collector cutoff current ($I_B = 0$)	$V_{CE} = -150V$	-50	μA
I_{EBO} Emitter cutoff current ($I_C = 0$)	for 2N5415 $V_{EB} = -4V$ for 2N5416 $V_{EB} = -6V$	-20 -20	μA μA
$V_{CEO(sus)}$ *Collector-emitter sustaining voltage ($I_B = 0$)	$I_C = -10mA$ for 2N5415 for 2N5416	-200 -300	V V
V_{CER} * Collector-emitter sustaining voltage ($R_{BE} = 50\Omega$)	$I_C = -50mA$ for 2N5416	-350	V
$V_{CE(sat)}$ * Collector-emitter saturation voltage	$I_C = -50mA$ $I_B = -5mA$	-2.5	V
V_{BE} * Base-emitter voltage	$I_C = -50mA$ $V_{CE} = -10V$	-1.5	V



2N5415
2N5416

ELECTRICAL CHARACTERISTICS (continued)

Parameter		Test conditions	Min. Typ. Max.		Unit
h_{FE}^*	DC current gain	$I_C = -50mA$ $V_{CE} = -10V$ for 2N5415 for 2N5416	30	150	—
h_{fe}	Small signal current gain	$I_C = -5mA$ $V_{CE} = -10V$ $f = 1KHz$	25		—
f_T	Transition frequency	$I_C = -10mA$ $V_{CE} = -10V$ $f = 5MHz$	15		MHz
C_{CBO}	Collector-base capacitance	$I_E = 0$ $V_{CB} = -10V$ $f = 1MHz$		25	pF

* Pulsed: pulse duration = 300 μs , duty cycle $\leq 2\%$

Safe operating areas

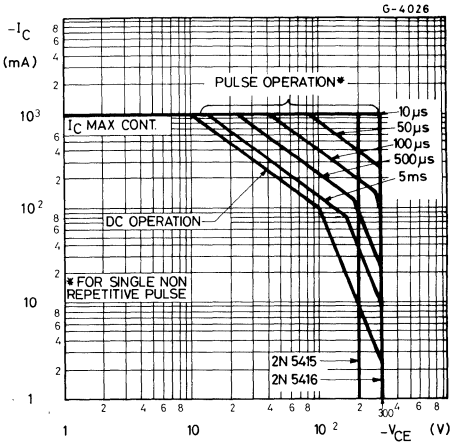

DC current gain

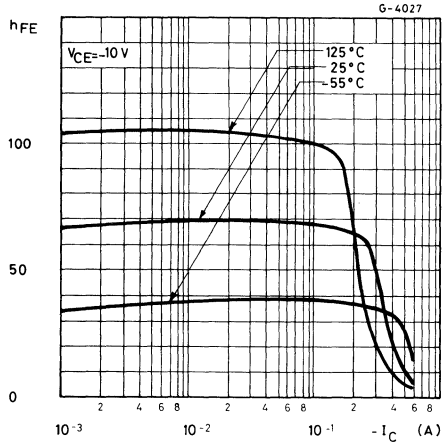

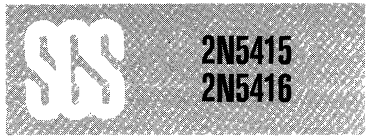

Collector-emitter saturation voltage

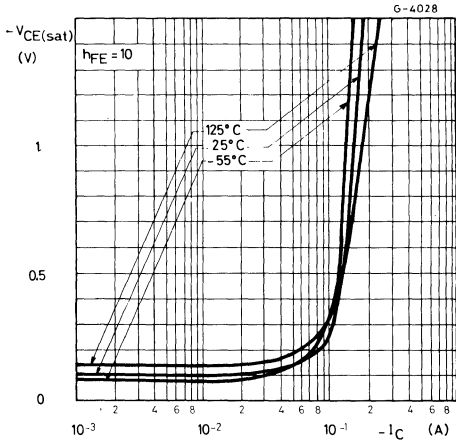

Base-emitter voltage

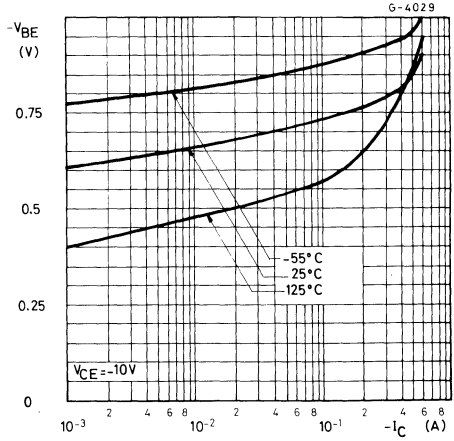

Transition frequency

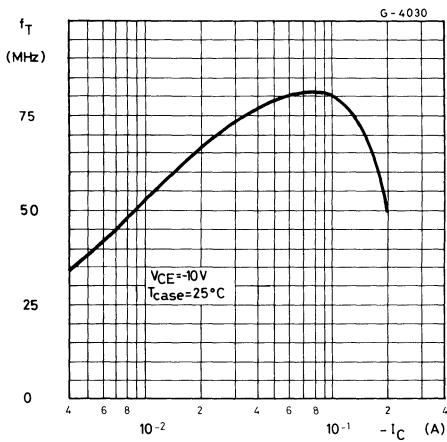

Switching times

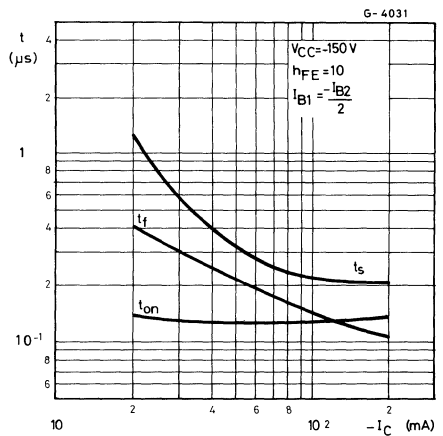



2N5671
2N5672

MULTIEPITAXIAL PLANAR NPN

HIGH CURRENT FAST SWITCHING APPLICATIONS

The 2N 5671 and 2N 5672 are silicon multiepitaxial planar NPN transistors in Jedec TO-3 metal case.

They are especially intended for high current, fast switching industrial applications.

ABSOLUTE MAXIMUM RATINGS

		2N5671	2N5672
V_{CBO}	Collector-base voltage ($I_E = 0$)	120V	150V
V_{CEX}	Collector-emitter voltage ($V_{BE} = -1.5$ V, $R_{BE} = 50 \Omega$)	120V	150V
V_{CER}	Collector-emitter voltage ($R_{BE} \leq 50 \Omega$)	110V	140V
V_{CEO}	Collector-emitter voltage ($I_B = 0$)	90V	120V
V_{EBO}	Emitter-base voltage ($I_C = 0$)	7V	
I_C	Collector current	30A	
I_B	Base current	10A	
P_{tot}	Total power dissipation at $T_{case} \leq 25^\circ C$	140W	
T_{stg}	Storage temperature	-65 to 200 °C	
T_j	Junction temperature	200 °C	

INTERNAL SCHEMATIC DIAGRAM

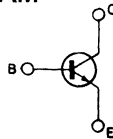

MECHANICAL DATA

Dimensions in mm

Collector connected to case

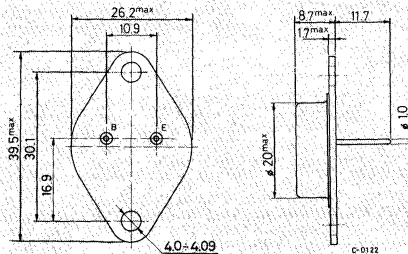

TO-3

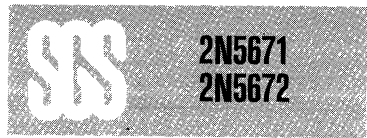

THERMAL DATA

$R_{th\ j-case}$	Thermal resistance junction-case	max 1.25 °C/W
------------------	----------------------------------	---------------

ELECTRICAL CHARACTERISTICS ($T_{case} = 25\text{ °C}$ unless otherwise specified)

Parameter	Test conditions	Min.	Typ.	Max.	Unit
I_{CEV}	Collector cutoff current ($V_{BE} = -1.5\text{ V}$)	for 2N5671 for 2N5672 $V_{CE} = 100\text{ V}$	$V_{CE} = 110\text{ V}$ $V_{CE} = 135\text{ V}$ $T_{case} = 150\text{ °C}$	12 10 15 10	mA mA mA mA
I_{CEO}	Collector cutoff current ($I_B = 0$)	$V_{CE} = 80\text{ V}$		10	mA
I_{EBO}	Emitter cutoff current ($I_C = 0$)	$V_{EB} = 7\text{ V}$		10	mA
$V_{CEX(sus)}$ *	Collector-emitter sustaining voltage ($V_{BE} = -1.5\text{ V}$, $R_{BE} = 50\Omega$)	$I_C = 200\text{ mA}$	for 2N5671 for 2N5672	120 150	V V
$V_{CER(sus)}$ *	Collector-emitter sustaining voltage ($R_{BE} = 50\Omega$)	$I_C = 200\text{ mA}$	for 2N5671 for 2N5672	110 140	V V
$V_{CEO(sus)}$ *	Collector-emitter sustaining voltage ($I_B = 0$)	$I_C = 200\text{ mA}$	for 2N5671 for 2N5672	90 120	V V
$V_{CE(sat)}$ *	Collector-emitter saturation voltage	$I_C = 15\text{ A}$	$I_B = 1.2\text{ A}$	0.75	V
$V_{BE(sat)}$ *	Base-emitter saturation voltage	$I_C = 15\text{ A}$	$I_B = 1.2\text{ A}$	1.5	V
V_{BE} *	Base-emitter voltage	$I_C = 15\text{ A}$	$V_{CE} = 5\text{ V}$	1.6	V
h_{FE} *	DC current gain	$I_C = 15\text{ A}$ $I_C = 20\text{ A}$	$V_{CE} = 2\text{ V}$ $V_{CE} = 5\text{ V}$	20 20	— —
f_T	Transition frequency	$I_C = 2\text{ A}$	$V_{CE} = 10\text{ V}$	50	MHz



2N5671
2N5672

ELECTRICAL CHARACTERISTICS (continued)

Parameter	Test conditions	Min.	Typ.	Max.	Unit
C_{CBO} Collector-base capacitance	$I_E = 0$ $V_{CB} = 10$ V $f = 1$ MHz		900		pF
t_{on} Turn-on time	$I_C = 15$ A $V_{CC} = 30$ V $I_{B1} = -I_{B2} = 1.2$ A		0.5		μ s
t_s Storage time			1.5		μ s
t_f Fall time			0.5		μ s
$I_{s/b}^{**}$ Second breakdown collector current	$V_{CE} = 24$ V $V_{CE} = 45$ V	5.8		0.9	A A
$E_{s/b}$ Second breakdown energy	$V_{BE} = -4$ V, $R_{BE} = 20$ Ω $L = 180$ μ H	20			mJ

* Pulsed: pulse duration = 300 μ s, duty cycle = 1.5%

** Pulsed: 1 s, non repetitive pulse

Safe operating areas

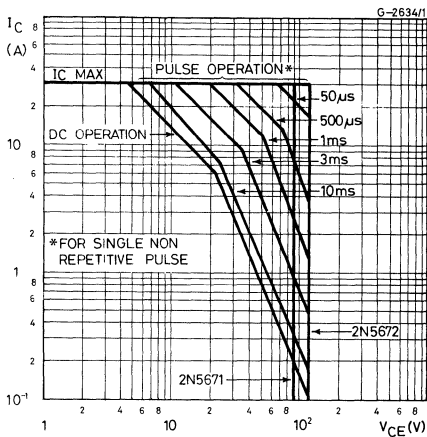

DC transconductance

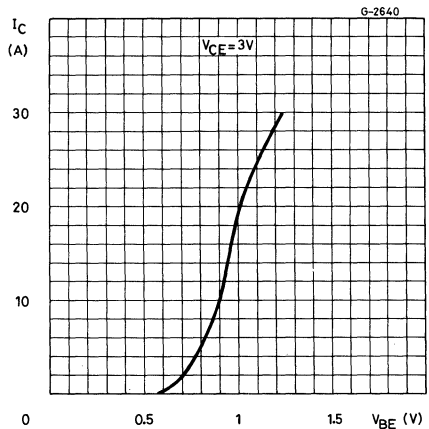

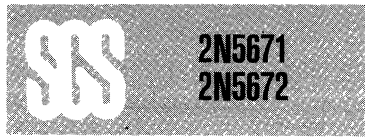

DC current gain

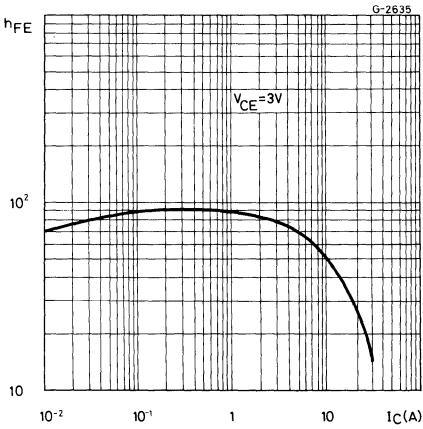

Collector-emitter saturation voltage

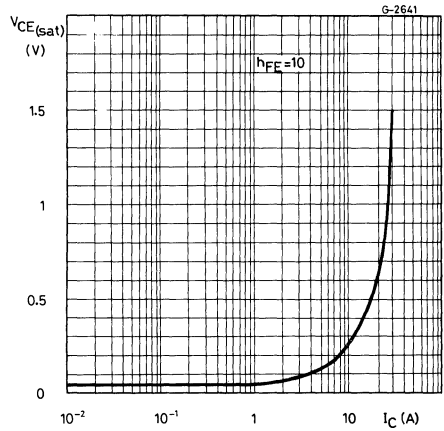

Base-emitter saturation voltage

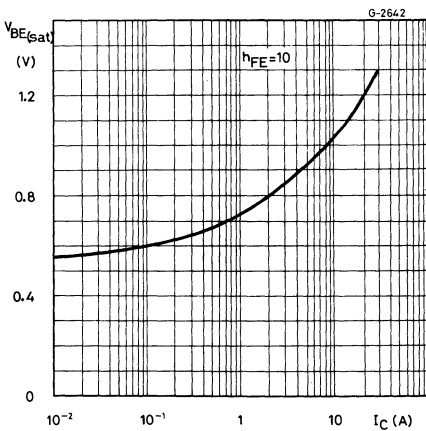

Saturated switching characteristics

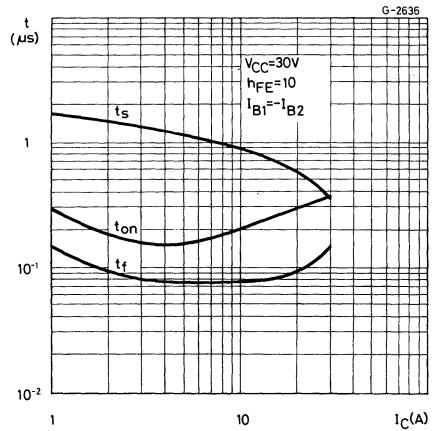



EPITAXIAL PLANAR PNP

PNP SILICON TRANSISTORS

The 2N5679 and 2N5680 are silicon epitaxial planar PNP transistors in Jedec TO-39 metal case intended for use as drivers for high power transistors in general purpose, amplifier and switching circuit.

The complementary NPN types are the 2N5681 and 2N5682 respectively.

ABSOLUTE MAXIMUM RATINGS

		2N5679	2N5680
V_{CBO}	Collector-base voltage ($I_E = 0$)	-100V	-120V
V_{CEO}	Collector-emitter voltage ($I_B = 0$)	-100V	-120V
V_{EBO}	Emitter-base voltage ($I_C = 0$)		-4V
I_C	Collector current		-1A
I_B	Base current		-0.5A
P_{tot}	Total power dissipation at $T_{case} \leq 25^\circ C$ $T_{amb} \leq 25^\circ C$		10W
T_{stg}	Storage temperature		1W
T_j	Junction temperature		-65 to 200°C
			200°C

INTERNAL SCHEMATIC DIAGRAM

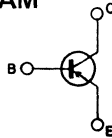

MECHANICAL DATA

Dimensions in mm

Collector connected to case

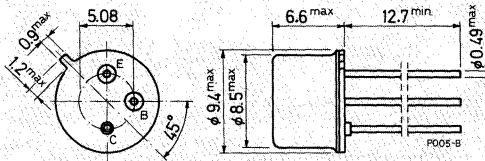

TO-39

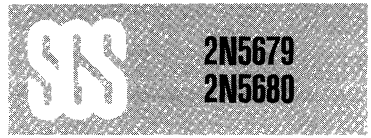

THERMAL DATA

$R_{th\ j-case}$	Thermal resistance junction-case	max	17.5	°C/W
$R_{th\ j-amb}$	Thermal resistance junction-ambient	max	175	°C/W

ELECTRICAL CHARACTERISTICS ($T_{case} = 25^{\circ}C$ unless otherwise specified)

Parameter	Test conditions	Min.	Typ.	Max.	Unit
I_{CBO}	Collector cutoff current ($I_E = 0$) for 2N5679 $V_{CB} = -100V$ for 2N5680 $V_{CB} = -120V$			-1 -1	μA μA
I_{CEV}	Collector cutoff current ($V_{BE} = 1.5$) for 2N5679 $V_{CE} = -100V$ for 2N5680 $V_{CE} = -120V$ $T_{case} = 150^{\circ}C$ for 2N5679 $V_{CE} = -100V$ for 2N5680 $V_{CE} = -120V$			-1 -1 -1 -1	μA μA mA mA
I_{CEO}	Collector cutoff current ($I_B = 0$) for 2N5679 $V_{CE} = -70V$ for 2N5680 $V_{CE} = -80V$			-10 -10	μA μA
I_{EBO}	Emitter cutoff current ($I_C = 0$) $V_{EB} = -4V$			-1	μA
$V_{CEO(sus)}$	*Collector-emitter sustaining voltage ($I_B = 0$) $I_C = -10mA$ for 2N5679 for 2N5680			-100 -120	V V
$V_{CE(sat)}$	*Collector-emitter saturation voltage $I_C = -250mA$ $I_B = -25mA$ $I_C = -500mA$ $I_B = -50mA$ $I_C = -1A$ $I_B = -200mA$			-0.6 -1 -2	V V V
V_{BE}	*Base-emitter voltage $I_C = -250mA$ $V_{CE} = -2V$			-1	V
h_{FE}	*DC current gain $I_C = -250mA$ $V_{CE} = -2V$ $I_C = -1A$ $V_{CE} = -2V$			40 5	150 —
f_T	Transition frequency $I_C = -100mA$ $V_{CE} = -10V$ $f = 10MHz$			30	MHz
C_{CBO}	Collector-base capacitance $I_E = 0$ $V_{CB} = -20V$ $f = 1MHz$			50	pF
h_{fe}	Small signal current gain $I_C = -0.2A$ $V_{CE} = -1.5V$ $f = 1KHz$			40	—

* Pulsed: pulse duration = 300 μs , duty cycle $\leq 2\%$.



EPITAXIAL PLANAR NPN

GENERAL PURPOSE TRANSISTORS

The 2N5681 and 2N5682 are silicon epitaxial planar NPN transistors in Jedec TO-39 metal case intended for use as drivers for high power transistors in general purpose amplifier and switching circuits. The complementary PNP types are the 2N5679 and 2N5680 respectively.

ABSOLUTE MAXIMUM RATINGS		2N5681	2N5682
V_{CBO}	Collector-base voltage ($I_E = 0$)	100V	120V
V_{CEO}	Collector-emitter voltage ($I_B = 0$)	100V	120V
V_{EBO}	Emitter-base voltage ($I_C = 0$)		4V
I_C	Collector current		1A
I_B	Base current		0.5A
P_{tot}	Total power dissipation at $T_{case} \leq 25^\circ C$ $T_{amb} \leq 25^\circ C$		10W 1W
T_{stg}	Storage temperature		-65 to 200°C
T_j	Junction temperature		200°C

INTERNAL SCHEMATIC DIAGRAM

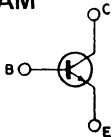

MECHANICAL DATA

Dimensions in mm

Collector connected to case

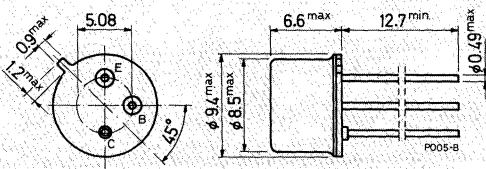

TO-39

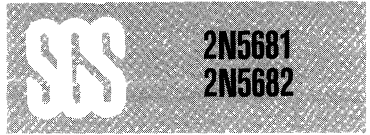

THERMAL DATA

$R_{th\ j-case}$	Thermal resistance junction-case	max	17.5	°C/W
$R_{th\ j-amb}$	Thermal resistance junction-ambient	max	175	°C/W

ELECTRICAL CHARACTERISTICS ($T_{case} = 25^{\circ}C$ unless otherwise specified)

Parameter	Test conditions	Min.	Typ.	Max.	Unit
I_{CBO}	Collector cutoff current ($I_E = 0$)	for 2N5681 for 2N5682	$V_{CB} = 100V$ $V_{CB} = 120V$	1 1	μA μA
I_{CEV}	Collector cutoff current ($V_{BE} = -1.5V$)	for 2N5681 for 2N5682 for 2N5681 for 2N5682	$V_{CE} = 100V$ $V_{CE} = 120V$ $T_{case} = 150^{\circ}C$ $V_{CE} = 100V$ $V_{CE} = 120V$	1 1 1 1	μA μA mA mA
I_{CEO}	Collector cutoff current ($I_B = 0$)	for 2N5681 for 2N5682	$V_{CE} = 70V$ $V_{CE} = 80V$	10 10	μA μA
I_{EBO}	Emitter cutoff current ($I_C = 0$)	$V_{EB} = 4V$		1	μA
$V_{CEO(sus)}$	*Collector-emitter sustaining voltage ($I_B = 0$)	$I_C = 10mA$ for 2N5681 for 2N5682		100 120	V V
$V_{CE(sat)}$	*Collector-emitter saturation voltage	$I_C = 250mA$ $I_C = 500mA$ $I_C = 1A$	$I_B = 25mA$ $I_B = 50mA$ $I_B = 200mA$	0.6 1 2	V V V
V_{BE}	*Base-emitter voltage	$I_C = 250mA$	$V_{CE} = 2V$	1	V
h_{FE}	*DC current gain	$I_C = 250mA$ $I_C = 1A$	$V_{CE} = 2V$ $V_{CE} = 2V$	40 5	— —
f_T	*Transition frequency	$I_C = 100mA$ $f = 10MHz$	$V_{CE} = 10V$	30	MHz
C_{CBO}	*Collector-base capacitance	$I_E = 0$ $f = 1MHz$	$V_{CB} = 20V$	50	pF
h_{fe}	*Small signal current gain	$I_C = 0.2A$ $f = 1KHz$	$V_{CE} = 1.5V$	40	—

* Pulsed: pulse duration = 300 μs , duty cycle $\leq 2\%$.



2N5875
2N5876

EPITAXIAL-BASE PNP

SILICON HIGH POWER TRANSISTORS

The 2N 5875 and 2N 5876 are silicon epitaxial-base PNP power transistors in Jedec TO-3 metal case. They are intended for use in power linear and switching applications. The complementary NPN types are the 2N 5877 and 2N 5878 respectively.

ABSOLUTE MAXIMUM RATINGS

		2N5875	2N5876
V_{CBO}	Collector-base voltage ($I_E = 0$)	-60V	-80V
V_{CEO}	Collector-emitter voltage ($I_B = 0$)	-60V	-80V
V_{EBO}	Emitter-base voltage ($I_C = 0$)		-5V
I_C	Collector current		-10A
I_{CM}	Collector peak current		-20A
I_B	Base current		-4A
P_{tot}	Total power dissipation at $T_{case} \leq 25^\circ C$		150W
T_{stg}	Storage temperature		-65 to $200^\circ C$
T_j	Junction temperature		$200^\circ C$

INTERNAL SCHEMATIC DIAGRAM

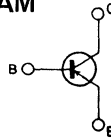

MECHANICAL DATA

Dimensions in mm

Collector connected to case

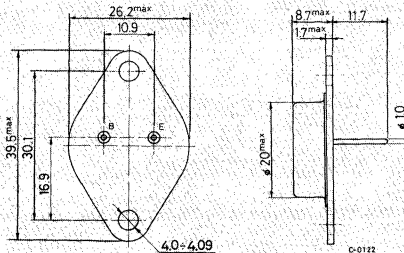

TO-3

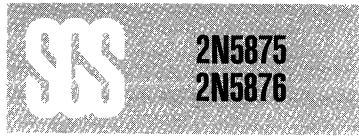

THERMAL DATA

$R_{th\ j-case}$	Thermal resistance junction-case	max	1.17 °C/W
------------------	----------------------------------	-----	-----------

ELECTRICAL CHARACTERISTICS ($T_{case} = 25^{\circ}C$ unless otherwise specified)

Parameter	Test conditions	Min.	Typ.	Max.	Unit
I_{CBO}	Collector cutoff current ($I_E = 0$)	for 2N5875 for 2N5876	$V_{CB} = -60V$ $V_{CB} = -80V$	-0.5 -0.5	mA mA
I_{CEO}	Collector cutoff current ($I_B = 0$)	for 2N5875 for 2N5876	$V_{CE} = -30V$ $V_{CE} = -40V$	-1 -1	mA mA
I_{CEX}	Collector cutoff current ($V_{BE} = 1.5 V$)	for 2N5875 for 2N5876 $T_{case} = 150^{\circ}C$ for 2N5875 for 2N5876	$V_{CE} = -60V$ $V_{CE} = -80V$ $V_{CE} = -60V$ $V_{CE} = -80V$	-0.5 -0.5 -5 -5	mA mA mA mA
I_{EBO}	Emitter cutoff current ($I_C = 0$)	$V_{EB} = -5 V$		-1	mA
$V_{CEO(sus)}^*$	Collector-emitter sustaining voltage ($I_B = 0$)	$I_C = -200 mA$ for 2N5875 for 2N5876		-60 -80	V V
$V_{CE(sat)}^*$	Collector-emitter saturation voltage	$I_C = -5 A$ $I_C = -10A$	$I_B = -0.5A$ $I_B = -2.5A$	-1 -3	V V
$V_{BE(sat)}^*$	Base-emitter saturation voltage	$I_C = -10A$	$I_C = -2.5A$	-2.5	V
V_{BE}^*	Base-emitter voltage	$I_C = -4A$	$V_{CE} = -4V$	-1.5	V



2N5875
2N5876

ELECTRICAL CHARACTERISTICS (continued)

Parameter	Test conditions	Min.	Typ.	Max.	Unit
h_{FE}^*	DC current gain	$I_C = -4A$ $I_C = -10A$	$V_{CE} = -4V$ $V_{CE} = -4V$	20 4	100 —
f_T	Transition frequency	$I_C = -0.5A$	$V_{CE} = -10V$	4	MHz
C_{CBO}	Collector-base capacitance	$V_{CB} = -10V$ $f = 1\text{ MHz}$	$I_E = 0$		500 pF
t_r	Rise time	$I_C = -4A$ $I_{B1} = -0.4A$	$V_{CC} = -30V$		0.7 μs
t_s	Storage time	$I_C = -4A$	$V_{CC} = -30V$		1 μs
t_f	Fall time	$I_{B1} = -I_{B2} = -0.4A$			0.8 μs

* Pulsed: pulse duration = 300 μs , duty cycle = 1.5%

Safe operating areas

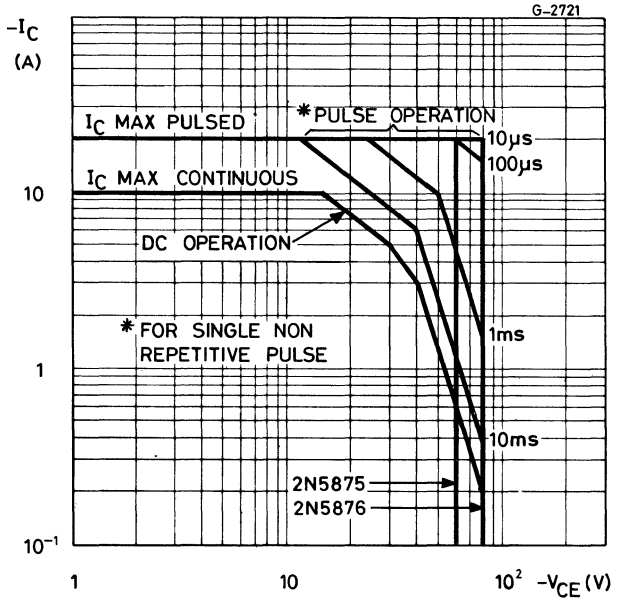



DC current gain

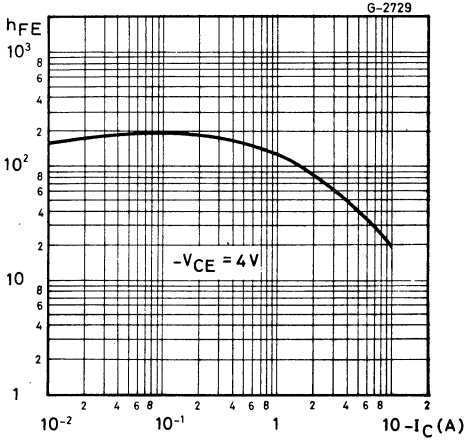

DC transconductance

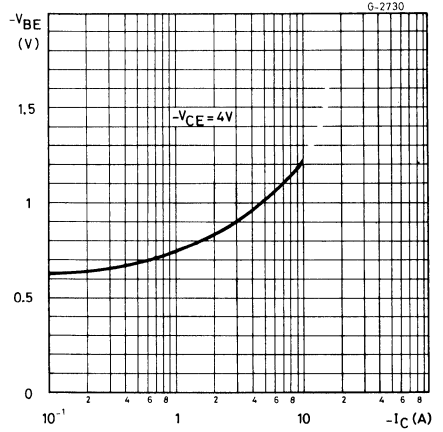

Collector-emitter saturation voltage

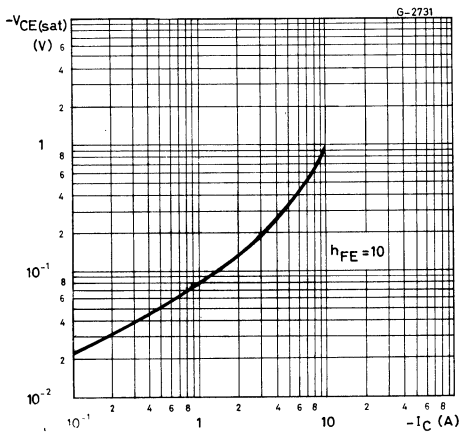

Base-emitter saturation voltage

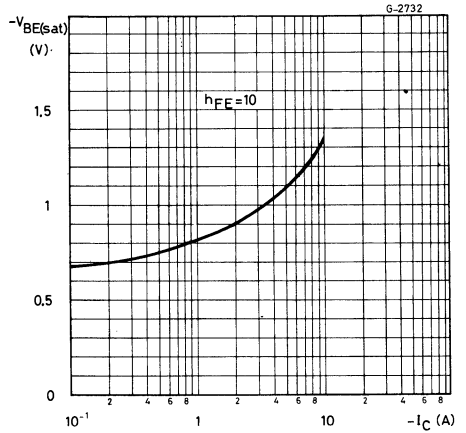

Collector-base capacitance

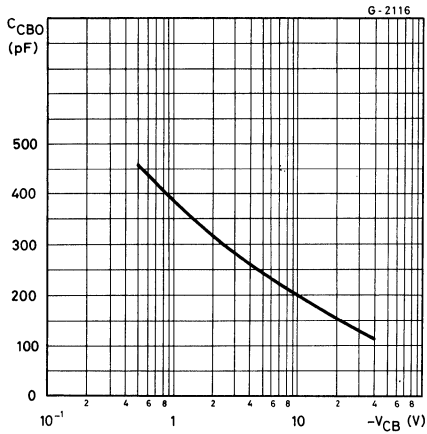

Saturated switching characteristics

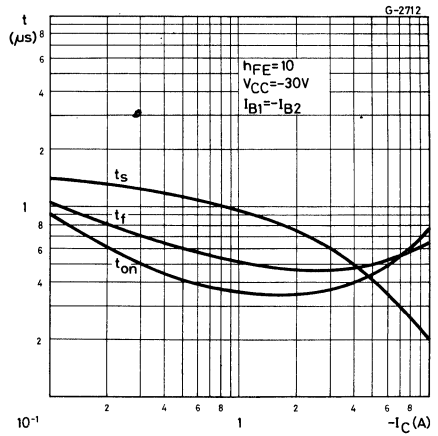

Power rating chart

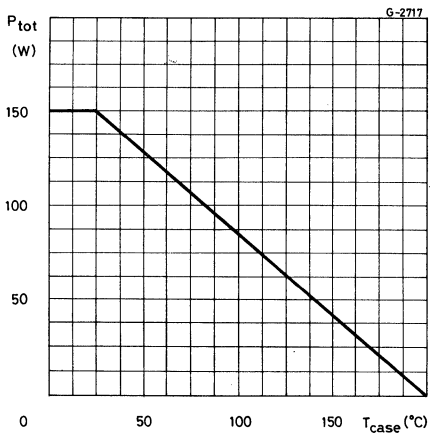



EPITAXIAL-BASE NPN

SILICON HIGH POWER TRANSISTORS

The 2N 5877 and 2N 5878 are silicon epitaxial-base NPN power transistors in Jedec TO-3 metal case. They are intended for use in power linear and switching applications. The complementary PNP types are the 2N 5875 and 2N 5876 respectively.

ABSOLUTE MAXIMUM RATINGS

		2N5877	2N5878
V_{CBO}	Collector-base voltage ($I_E = 0$)	60V	80V
V_{CEO}	Collector-emitter voltage ($I_B = 0$)	60V	80V
V_{EBO}	Emitter-base voltage ($I_C = 0$)		5V
I_C	Collector current		10A
I_{CM}	Collector peak current		20A
I_B	Base current		4A
P_{tot}	Total power dissipation at $T_{case} \leq 25^\circ C$		150W
T_{stg}	Storage temperature		-65 to 200°C
T_j	Junction temperature		200°C

INTERNAL SCHEMATIC DIAGRAM

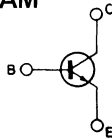

MECHANICAL DATA

Dimensions in mm

Collector connected to case

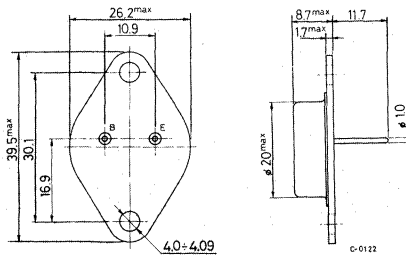

TO-3



2N5877
2N5878

THERMAL DATA

$R_{th\ j-case}$	Thermal resistance junction-case	max	1.17	°C/W
------------------	----------------------------------	-----	------	------

ELECTRICAL CHARACTERISTICS ($T_{case} = 25^{\circ}C$ unless otherwise specified)

Parameter	Test conditions	Min.	Typ.	Max.	Unit
I_{CB0}	Collector cutoff current ($I_E = 0$)	for 2N5877 for 2N5878	$V_{CB} = 60V$ $V_{CB} = 80V$	0.5 0.5	mA mA
I_{CEO}	Collector cutoff current ($I_B = 0$)	for 2N5877 for 2N5878	$V_{CE} = 30V$ $V_{CE} = 40V$	1 1	mA mA
I_{CEX}	Collector cutoff current ($V_{BE} = -1.5V$)	for 2N5877 for 2N5878 $T_{case} = 150^{\circ}C$ for 2N5877 for 2N5878	$V_{CE} = 60V$ $V_{CE} = 80V$ $V_{CE} = 60V$ $V_{CE} = 80V$	0.5 0.5 5 5	mA mA mA mA
I_{EBO}	Emitter cutoff current ($I_C = 0$)	$V_{EB} = 5V$		1	mA
$V_{CEO(sus)}$ *	Collector-emitter sustaining voltage ($I_B = 0$)	$I_C = 200mA$	for 2N5877 for 2N5878	60 80	V V
$V_{CE(sat)}$ *	Collector emitter saturation voltage	$I_C = 5A$ $I_C = 10A$	$I_B = 0.5A$ $I_B = 2.5A$	1 3	V V
$V_{BE(sat)}$ *	Base-emitter saturation voltage	$I_C = 10A$	$I_C = 2.5A$	2.5	V
V_{BE} *	Base-emitter voltage	$I_C = 4A$	$V_{CE} = 4V$	1.5	V



ELECTRICAL CHARACTERISTICS (continued)

Parameter	Test conditions	Min.	Typ.	Max.	Unit
h_{FE}^* DC current gain	$I_C = 4A$ $V_{CE} = 4V$	20		100	—
	$I_C = 10A$ $V_{CE} = 4V$	4			—
f_T Transition frequency	$I_C = 0.5A$ $V_{CE} = 10V$	4			MHz
C_{CBO} Collector-base capacitance	$V_{CB} = 10V$ $f = 1\text{ MHz}$ $I_E = 0$			300	pF
t_r Rise time	$I_C = 4A$ $V_{CC} = 30V$ $I_{B1} = 0.4A$			0.7	μs
t_s Storage time	$I_C = 4A$ $V_{CC} = 30V$ $I_{B1} = -I_{B2} = 0.4A$			1	μs
t_f Fall time				0.8	μs

* Pulsed: pulse duration = 300 μs , duty cycle = 1.5%

Safe operating areas

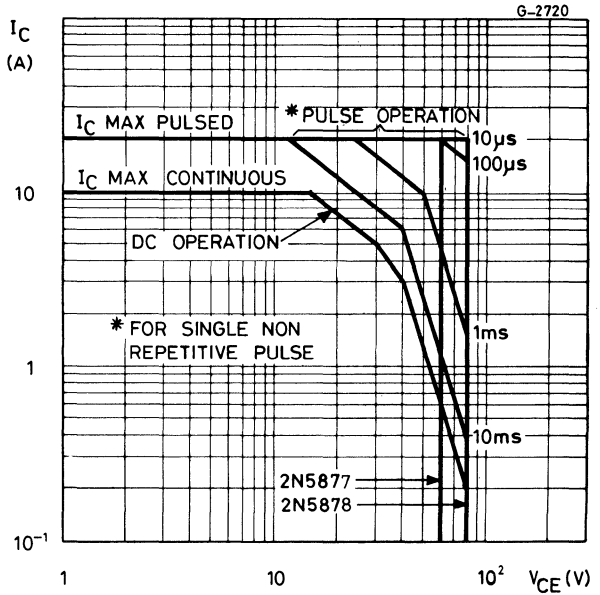



2N5877
2N5878

DC current gain

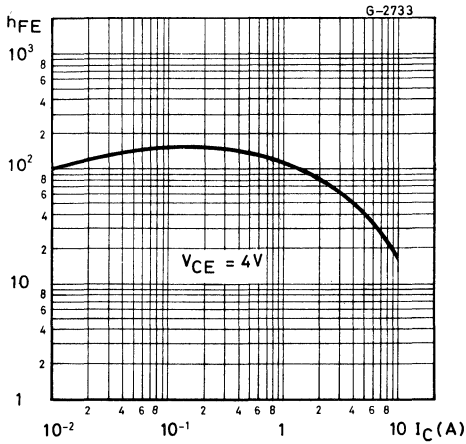

DC transconductance

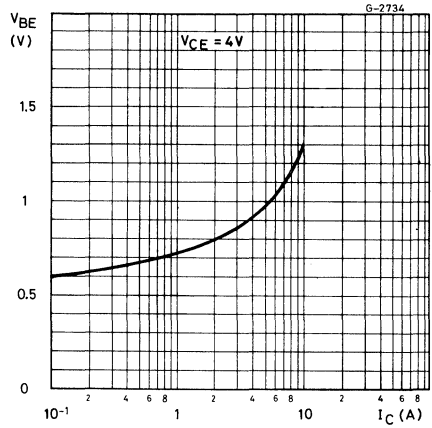

Collector-emitter saturation voltage

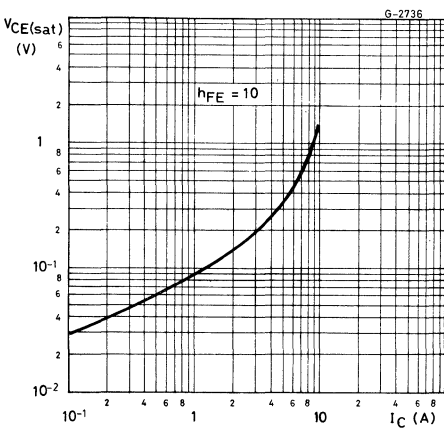

Base-emitter saturation voltage

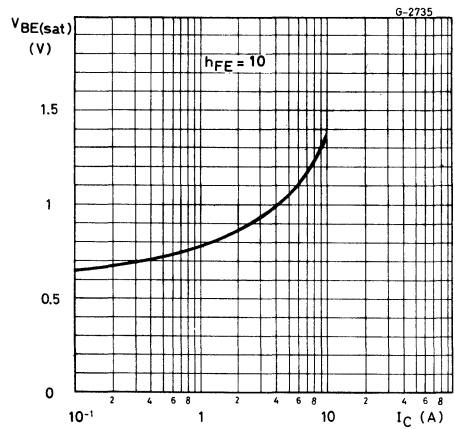



Collector-base capacitance

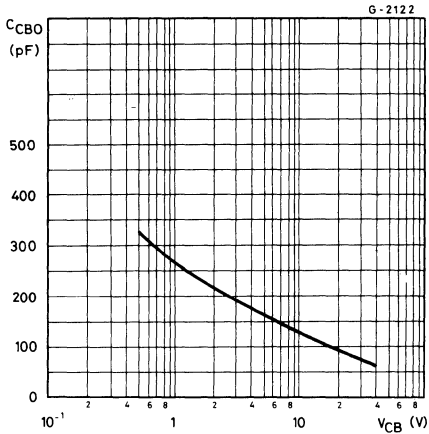

Saturated switching characteristics

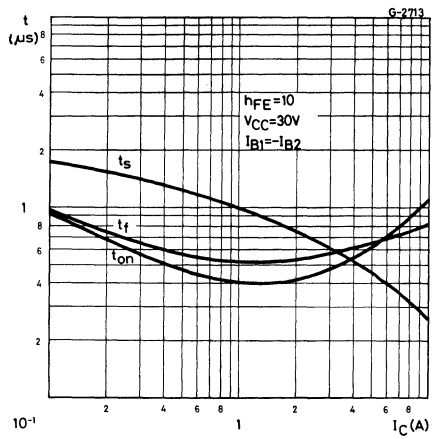

Power rating chart

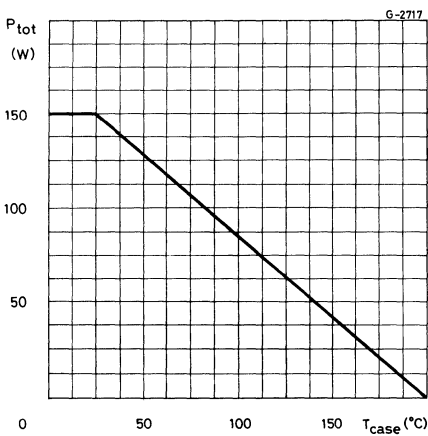



2N6032
2N6033

MULTIEPITAXIAL PLANAR NPN

HIGH CURRENT, HIGH SPEED, HIGH POWER TRANSISTORS

The 2N 6032 and 2N 6033 are silicon multiepitaxial planar NPN transistors in modified Jedec TO-3 metal case.

They have high current, high power handling capability, fast switching speed and are intended for use in switching and linear applications in military and industrial equipment.

ABSOLUTE MAXIMUM RATINGS

		2N6032	2N6033
V_{CBO}	Collector-base voltage ($I_E = 0$)	120V	150V
V_{CEX}	Collector-emitter voltage ($V_{BE} = -1.5 \text{ V}$, $R_{BE} = 50 \Omega$)	120V	150V
V_{CER}	Collector-emitter voltage ($R_{BE} = 50 \Omega$)	110V	140V
V_{CEO}	Collector-emitter voltage ($I_B = 0$)	90	120V
V_{EBO}	Emitter-base voltage ($I_C = 0$)	7V	7V
I_C	Collector current	50A	40A
I_B	Base current		10A
P_{tot}	Total power dissipation at $T_{case} \leq 25 \text{ }^\circ\text{C}$		140W
T_{stg}	Storage temperature	-65 to 200 $^\circ\text{C}$	
T_j	Junction temperature		200 $^\circ\text{C}$

INTERNAL SCHEMATIC DIAGRAM

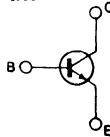

MECHANICAL DATA

Dimensions in mm

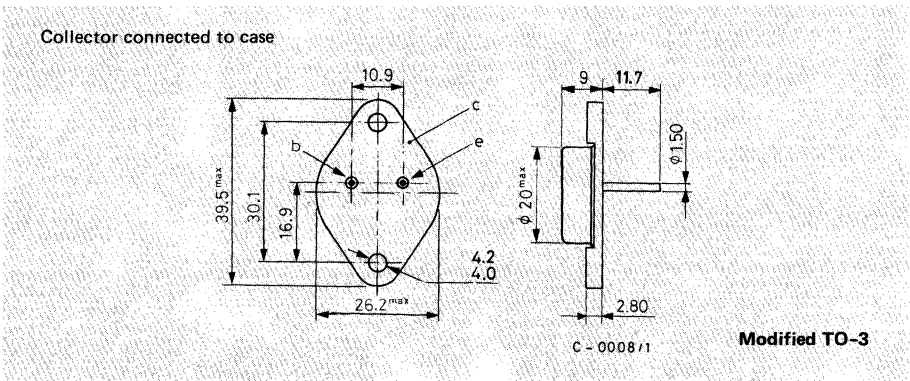



THERMAL DATA

$R_{th\ j-case}$	Thermal resistance junction-case	max	1.25	°C/W
------------------	----------------------------------	-----	------	------

ELECTRICAL CHARACTERISTICS ($T_{case} = 25\text{ °C}$ unless otherwise specified)

Parameter	Test conditions	Min.	Typ.	Max.	Unit	
I_{CEV}	Collector cutoff current ($V_{BE} = -1.5\text{ V}$)	for 2N6032 $V_{CE} = 110\text{ V}$ $V_{CE} = 100\text{ V}$ for 2N6033 $V_{CE} = 135\text{ V}$ $V_{CE} = 100\text{ V}$		$T_{case} = 150\text{ °C}$	12 15 10 10	mA mA mA mA
I_{CEO}	Collector cutoff current ($I_B = 0$)	$V_{CE} = 80\text{ V}$			10	mA
I_{EBO}	Emitter cutoff current ($I_C = 0$)	$V_{EB} = 7\text{ V}$			10	mA
$V_{CEX(sus)}$ *	Collector-emitter sustaining voltage ($V_{BE} = -1.5\text{ V}$, $R_{BE} = 50\Omega$, $L = 2\text{ mH}$)	$I_C = 200\text{ mA}$ for 2N6032 for 2N6033			120 150	V V
$V_{CER(sus)}$ *	Collector-emitter sustaining voltage ($R_{BE} = 50\Omega$, $L = 15\text{ mH}$)	$I_C = 200\text{ mA}$ for 2N6032 for 2N6033			110 140	V V
$V_{CEO(sus)}$ *	Collector-emitter sustaining voltage ($I_B = 0$)	$I_C = 200\text{ mA}$ for 2N6032 for 2N6033			90 120	V V
$V_{CE(sat)}$ *	Collector-emitter saturation voltage	for 2N6032 $I_C = 50\text{ A}$ for 2N6033 $I_C = 40\text{ A}$	$I_B = 5\text{ A}$ $I_B = 4\text{ A}$		1.3 1	V V
$V_{BE(sat)}$ *	Base-emitter saturation voltage	for 2N6032 $I_C = 50\text{ A}$ for 2N6033 $I_C = 40\text{ A}$	$I_B = 5\text{ A}$ $I_B = 4\text{ A}$		2 2	V V



2N6032
2N6033

ELECTRICAL CHARACTERISTICS (continued)

Parameter	Test conditions	Min.	Typ.	Max.	Unit
V_{BE}^* Base-emitter voltage	for 2N6032 $I_C = 50\text{ A}$ $V_{CE} = 2\text{ V}$			2	V
	for 2N6033 $I_C = 40\text{ A}$ $V_{CE} = 2\text{ V}$			2	V
h_{FE}^* DC current gain	for 2N6032 $I_C = 50\text{ A}$ $V_{CE} = 2.6\text{ V}$	10		50	—
	for 2N6033 $I_C = 40\text{ A}$ $V_{CE} = 2\text{ V}$	10		50	—
h_{fe} Small-signal current gain	$I_C = 2\text{ A}$ $V_{CE} = 10\text{ V}$ $f = 5\text{ MHz}$	10			—
C_{CBO} Collector-base capacitance	$I_E = 0$ $V_{CB} = 10\text{ V}$ $f = 1\text{ MHz}$			800	pF
t_r Rise time	for 2N6032 $I_C = 50\text{ A}$ $V_{CC} = 30\text{ V}$ $I_{B1} = -I_{B2} = 5\text{ A}$			1	μs
t_s Storage time	for 2N6033 $I_C = 40\text{ A}$ $V_{CC} = 30\text{ V}$ $I_{B1} = -I_{B2} = 4\text{ A}$			1.5	μs
t_f Fall time				0.5	μs
$I_{S/b}^{**}$ Second breakdown collector current	$V_{CE} = 24\text{ V}$	5.8			A
	$V_{CE} = 40\text{ V}$	0.9			A
$E_{S/b}$ Second breakdown energy	$V_{BE} = -4\text{ V}$, $R_{BE} = 5\ \Omega$ $L = 310\ \mu\text{H}$	62			mJ

* Pulsed: pulse duration = 300 μs , duty cycle = 1.5%

** Pulsed: 1 s non repetitive pulse

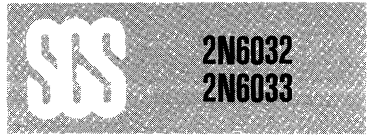

Safe operating areas

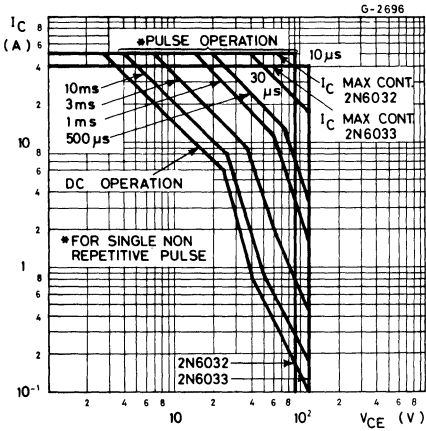

DC current gain

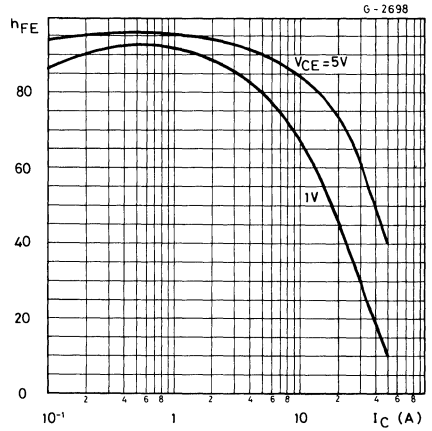

Collector-emitter saturation voltage

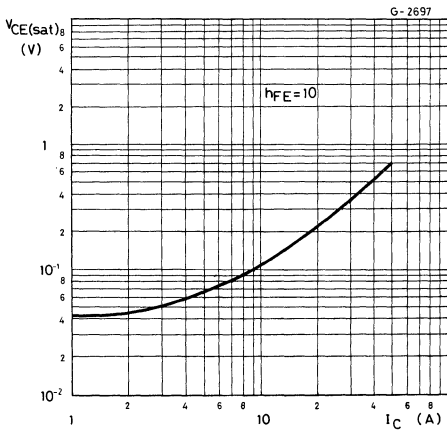

Collector-emitter saturation voltage

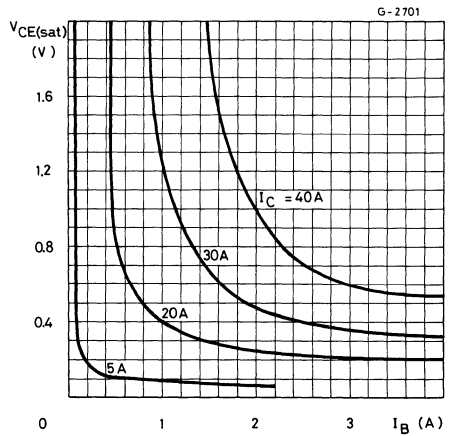



2N6032
2N6033

Base-emitter saturation voltage

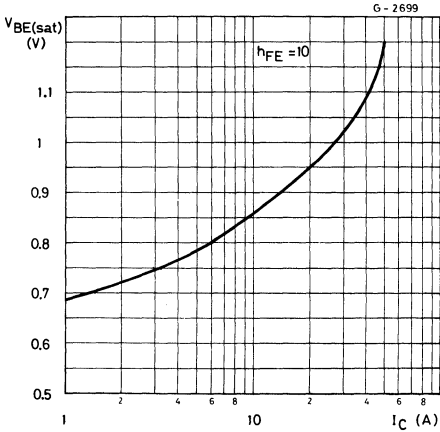

Collector-base capacitance

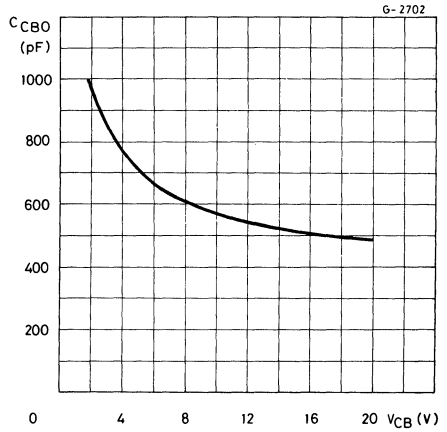

Saturated switching characteristics

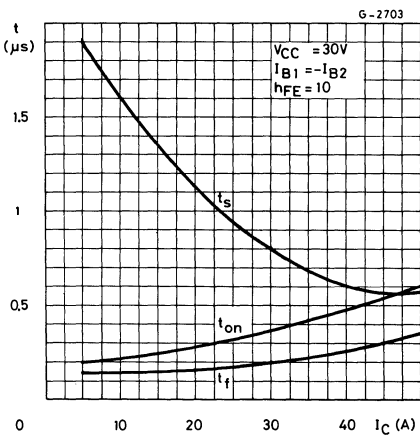

Power rating chart

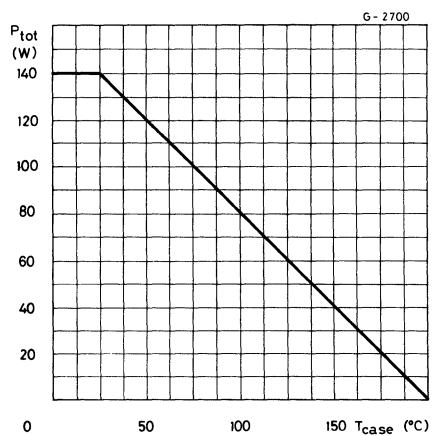

EPITAXIAL-BASE PNP

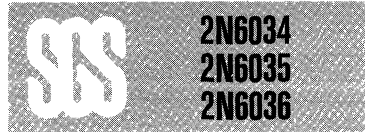

MEDIUM POWER DARLINGTONS

The 2N 6034, 2N 6035 and 2N 6036 are silicon epitaxial-base PNP power transistors in monolithic Darlington configuration and are mounted in Jedec TO-126 plastic package. They are intended for use in medium power linear and switching applications. The complementary NPN types are the 2N 6037, 2N 6038 and 2N 6039 respectively.

ABSOLUTE MAXIMUM RATINGS

		2N6034	2N6035	2N6036
V_{CBO}	Collector-base voltage ($I_E = 0$)	-40V	-60V	-80V
V_{CEO}	Collector-emitter voltage ($I_B = 0$)	-40V	-60V	-80V
V_{EBO}	Emitter-base voltage ($I_C = 0$)		-5V	
I_C	Collector current		-4A	
I_{CM}	Collector peak current		-8A	
I_B	Base current		-100mA	
P_{tot}	Total power dissipation at $T_{case} \leq 25^\circ C$		40W	
T_{stg}	Storage temperature		-65 to 150°C	
T_j	Junction temperature		150°C	

INTERNAL SCHEMATIC DIAGRAM

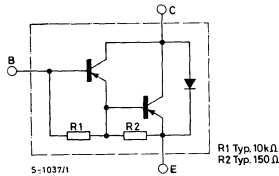

MECHANICAL DATA

Dimensions in mm

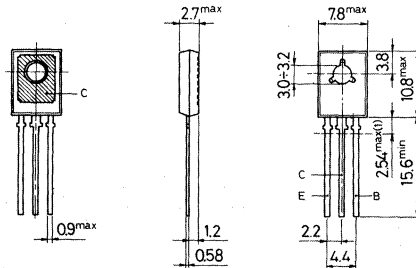

(1) Within this region the cross-section of the leads is uncontrolled

TO-126 (SOT-32)

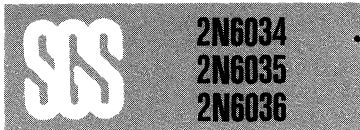

THERMAL DATA

$R_{th\ j-case}$	Thermal resistance junction-case	max	3.12	°C/W
$R_{th\ j-amb}$	Thermal resistance junction-ambient	max	83.3	°C/W

ELECTRICAL CHARACTERISTICS ($T_{case} = 25^{\circ}C$ unless otherwise specified)

Parameter	Test conditions	Min.	Typ.	Max.	Unit
I_{CBO}	Collector cutoff current ($I_E = 0$)	for 2N6034 for 2N6035 for 2N6036	$V_{CB} = -40V$ $V_{CB} = -60V$ $V_{CB} = -80V$	-500 -500 -500	μA μA μA
I_{CEO}	Collector cutoff current ($I_B = 0$)	for 2N6034 for 2N6035 for 2N6036	$V_{CE} = -20V$ $V_{CE} = -30V$ $V_{CE} = -40V$	-500 -500 -500	μA μA A
I_{CEX}	Collector cutoff current ($V_{EB} = -1.5V$)	for 2N6034 for 2N6035 for 2N6036 $T_{case} = 125^{\circ}C$ for 2N6034 for 2N6035 for 2N6036	$V_{CE} = -40V$ $V_{CE} = -60V$ $V_{CE} = -80V$ $V_{CE} = -40V$ $V_{CE} = -60V$ $V_{CE} = -80V$	-0.5 -0.5 -0.5 -2 2 -2	mA mA mA mA mA mA
I_{EBO}	Emitter cutoff current ($I_C = 0$)	$V_{EB} = -5V$		-2	mA
$V_{CEO(sus)}^*$	Collector-emitter sustaining voltage ($I_B = 0$)	$I_C = -100mA$	for 2N6034 for 2N6035 for 2N6036	-40 -60 -80	V V V
$V_{CE(sat)}^*$	Collector-emitter saturation voltage	$I_C = -2A$ $I_C = -4A$	$I_B = -8mA$ $I_B = -40mA$	-2 -3	V V
V_{BE}^*	Base-emitter voltage	$I_C = -2A$	$V_{CE} = -3V$	-2.8	V
h_{FE}^*	DC current gain	$I_C = -0.5A$ $I_C = -2A$ $I_C = -4A$	$V_{CE} = -3V$ $V_{CE} = -3V$ $V_{CE} = -3V$	500 750 100	15000 — —
h_{fe}	Small signal current gain	$I_C = -0.75$ $f = 1\ MHz$	$V_{CE} = -10V$	1	—
C_{CBO}	Collector-base capacitance	$V_{CB} = -10V$ $f = 1\ MHz$	$I_E = 0$	200	pF

* Pulsed: pulse duration = 300 μs , duty cycle = 1.5%

Safe operating areas

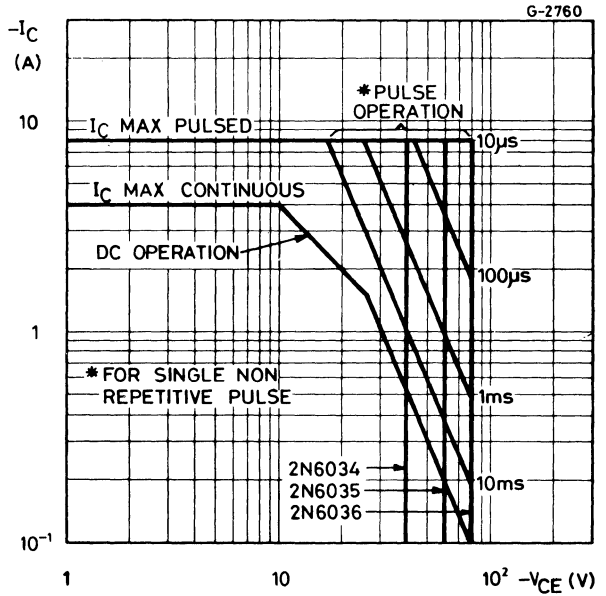

DC current gain

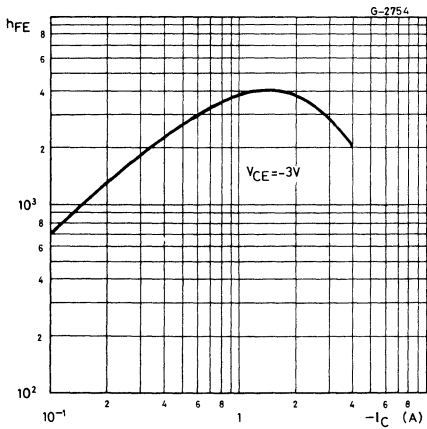

DC transconductance

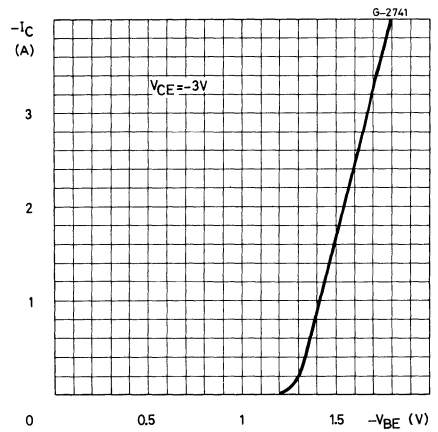



Collector-emitter saturation voltage

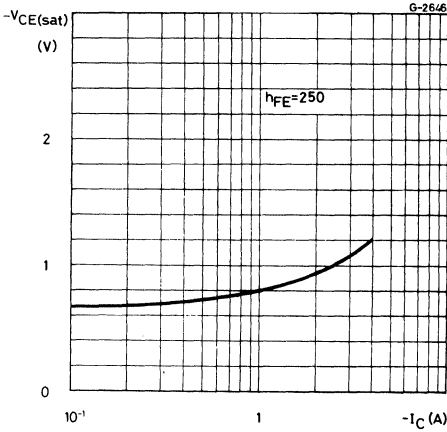

Collector-emitter saturation voltage

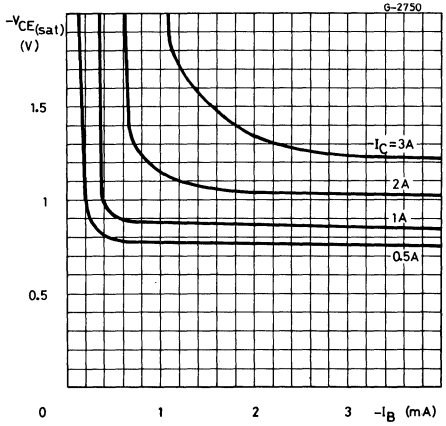

Small signal current gain

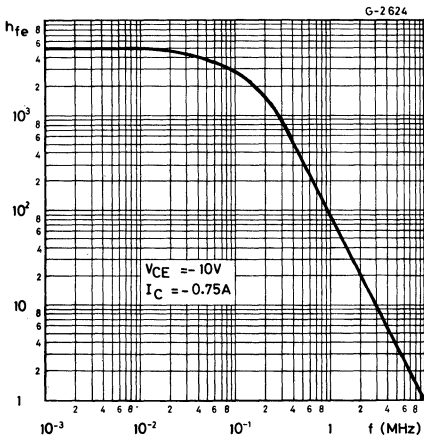

Saturated switching characteristics

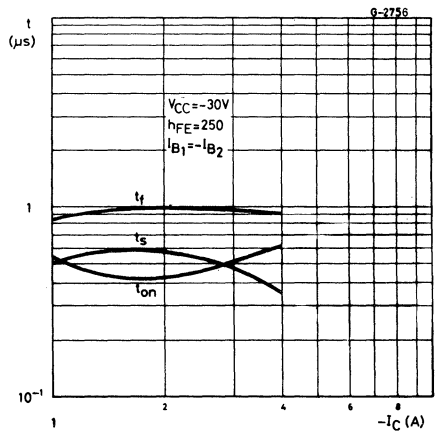



EPITAXIAL-BASE NPN

MEDIUM POWER DARLINGTONS

The 2N 6037, 2N 6038 and 2N 6039 are silicon epitaxial-base NPN power transistors in monolithic Darlington configuration and are mounted in Jedec TO-126 plastic package. They are intended for use in medium power linear and switching applications. The complementary PNP types are the 2N 6034, 2N 6035 and 2N 6036 respectively.

ABSOLUTE MAXIMUM RATINGS

		2N6037	2N6038	2N6039
V_{CBO}	Collector-base voltage ($I_E = 0$)	40V	60V	80V
V_{CEO}	Collector-emitter voltage ($I_B = 0$)	40V	60V	80V
V_{EBO}	Emitter-base voltage ($I_C = 0$)		5V	
I_C	Collector current		4A	
I_{CM}	Collector peak current		8A	
I_B	Base current		100mA	
P_{tot}	Total power dissipation at $T_{case} \leq 25^\circ C$		40W	
T_{stg}	Storage temperature		-65 to $150^\circ C$	
T_j	Junction temperature		150°C	

INTERNAL SCHEMATIC DIAGRAM

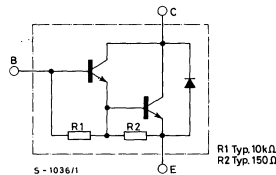

MECHANICAL DATA

Dimensions in mm

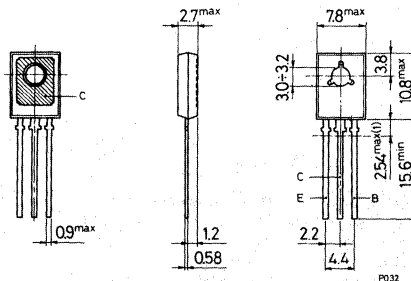

(1) Within this region the cross-section of the leads is uncontrolled

TO-126 (SOT-32)



2N6037
2N6038
2N6039

THERMAL DATA

$R_{th\ j-case}$	Thermal resistance junction-case	max	3.12	°C/W
$R_{th\ j-amb}$	Thermal resistance junction-ambient	max	83.3	°C/W

ELECTRICAL CHARACTERISTICS ($T_{case} = 25^{\circ}C$ unless otherwise specified)

Parameter	Test conditions	Min.	Typ.	Max.	Unit
I_{CBO}	Collector cutoff current ($I_E = 0$)	for 2N6037 for 2N6038 for 2N6039	$V_{CB} = 40V$ $V_{CB} = 60V$ $V_{CB} = 80V$	500 500 500	μA μA μA
I_{CEO}	Collector cutoff current ($I_B = 0$)	for 2N6037 for 2N6038 for 2N6039	$V_{CE} = 20V$ $V_{CE} = 30V$ $V_{CE} = 40V$	500 500 500	μA μA μA
I_{CEX}	Collector cutoff current ($V_{EB} = 1.5V$)	for 2N6037 for 2N6038 for 2N6039 $T_{case} = 125^{\circ}C$ for 2N6037 for 2N6038 for 2N6039	$V_{CE} = 40V$ $V_{CE} = 60V$ $V_{CE} = 80V$ $V_{CE} = 40V$ $V_{CE} = 60V$ $V_{CE} = 80V$	0.5 0.5 0.5 2 2 2	mA mA mA mA mA mA
I_{EBO}	Emitter cutoff current ($I_C = 0$)	$V_{EB} = 5V$		2	mA
$V_{CEO(sus)}^*$	Collector-emitter sustaining voltage ($I_B = 0$)	$I_C = 100mA$	for 2N6037 for 2N6038 for 2N6039	40 60 80	V V V
$V_{CE(sat)}^*$	Collector-emitter saturation voltage	$I_C = 2A$ $I_C = 4A$	$I_B = 8mA$ $I_B = 40mA$	2 3	V V
V_{BE}^*	Base-emitter voltage	$I_C = 2A$	$V_{CE} = 3V$	2.8	V
h_{FE}^*	DC current gain	$I_C = 0.5A$ $I_C = 2A$ $I_C = 4A$	$V_{CE} = 3V$ $V_{CE} = 3V$ $V_{CE} = 3V$	500 750 100	15000 — —
h_{fe}	Small signal current gain	$I_C = 0.75A$ $f = 1\ MHz$	$V_{CE} = 10V$	1	—
C_{CBO}	Collector-base capacitance	$V_{CB} = 10V$ $f = 1\ MHz$	$I_E = 0$	100	pF

* Pulsed: pulse duration = 300 μs , duty cycle = 1.5%

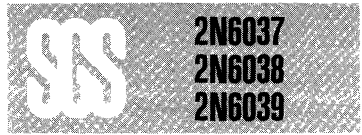

Safe operating areas

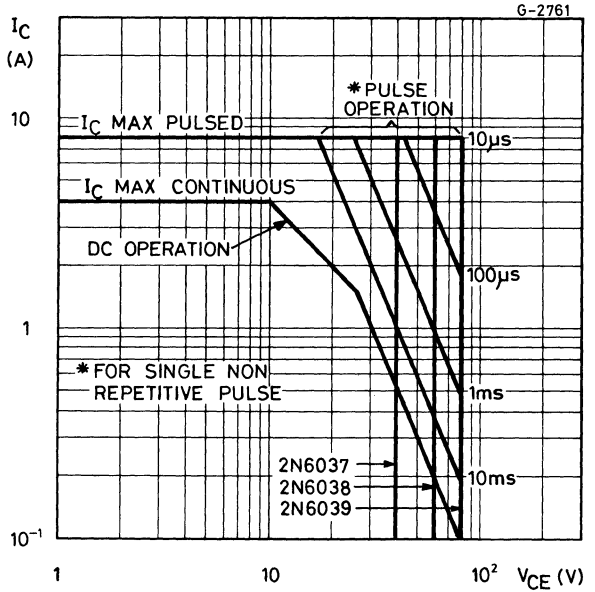

DC current gain

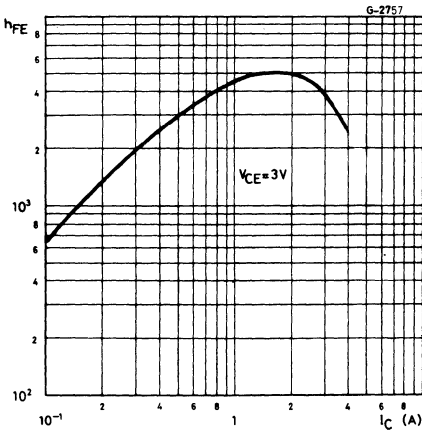

DC transconductance

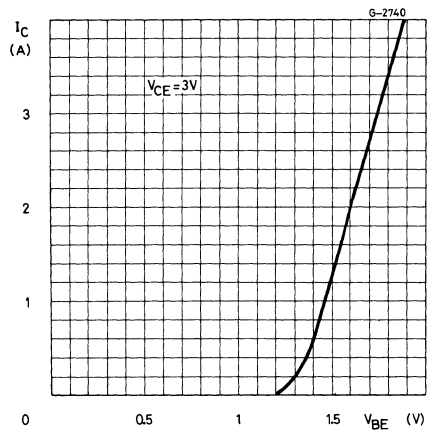

Collector-emitter saturation voltage

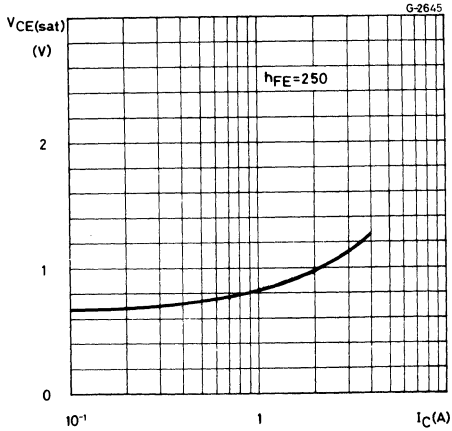

Collector-emitter saturation voltage

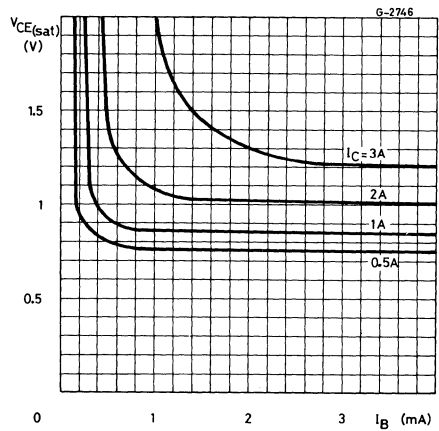

Small signal current gain

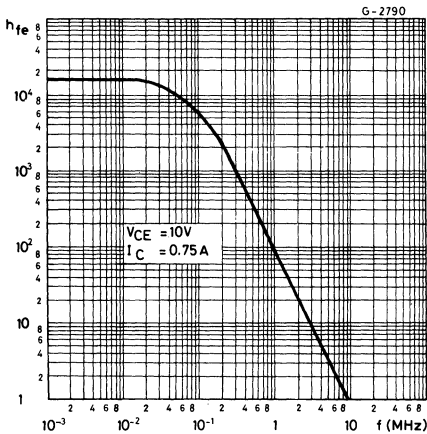

Saturated switching characteristics

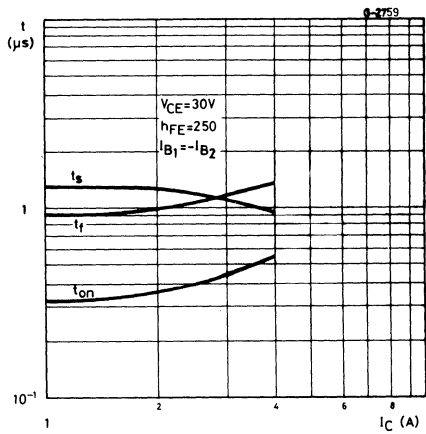



EPITAXIAL-BASE PNP

POWER DARLINGTONS

The 2N 6050, 2N 6051 and 2N 6052 are silicon epitaxial-base PNP transistors in monolithic Darlington configuration and are mounted in Jedec TO-3 metal case. They are intended for use in power linear and switching applications. The complementary NPN types are the 2N 6057, 2N 6058 and 2N 6059 respectively.

ABSOLUTE MAXIMUM RATINGS

		2N6050	2N6051	2N6052
V_{CBO}	Collector-base voltage ($I_E = 0$)	-60V	-80V	-100V
V_{CEO}	Collector-emitter voltage ($I_B = 0$)	-60V	-80V	-100V
V_{EBO}	Emitter-base voltage ($I_C = 0$)		-5V	
I_C	Collector current		-12A	
I_{CM}	Collector peak current		-20A	
I_B	Base current		-0.2A	
P_{tot}	Total power dissipation at $T_{case} \leq 25^\circ C$		150W	
T_{stg}	Storage temperature		-65 to 200°C	
T_j	Junction temperature		200°C	

INTERNAL SCHEMATIC DIAGRAM

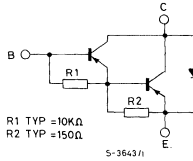

MECHANICAL DATA

Dimensions in mm

Collector connected to case

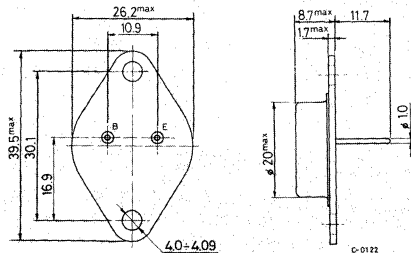

TO-3



2N6050
2N6051
2N6052

THERMAL DATA

$R_{th\ j-case}$	Thermal resistance junction-case	max	1.17	$^{\circ}C/W$
------------------	----------------------------------	-----	------	---------------

ELECTRICAL CHARACTERISTICS ($T_{case} = 25^{\circ}C$ unless otherwise specified)

Parameter	Test conditions	Min.	Typ.	Max.	Unit
I_{CEO} Collector cutoff current ($I_B = 0$)	for 2N6050 $V_{CE} = -30V$			-1	mA
	for 2N6051 $V_{CE} = -40V$			-1	mA
	for 2N6052 $V_{CE} = -50V$			-1	mA
I_{CEX} Collector cutoff current ($V_{EB} = -1.5V$)	for 2N6050 $V_{CE} = -60V$			-0.5	mA
	for 2N6051 $V_{CE} = -80V$			-0.5	mA
	for 2N6052 $V_{CE} = -100V$			-0.5	mA
	$T_{case} = 150^{\circ}C$				
	for 2N6050 $V_{CE} = -60V$			-5	mA
for 2N6051 $V_{CE} = -80V$			-5	mA	
for 2N6052 $V_{CE} = -100V$			-5	mA	
I_{EBO} Emitter cutoff current ($I_C = 0$)	$V_{EB} = -5V$			-2	mA
$V_{CEO(sus)}^*$ Collector-emitter sustaining voltage ($I_B = 0$)	$I_C = -100mA$				
	for 2N6050	-60			V
	for 2N6051	-80			V
	for 2N6052	-100			V
$V_{CE(sat)}^*$ Collector-emitter saturation voltage	$I_C = -6A$ $I_B = -24mA$			-2	V
	$I_C = -12A$ $I_B = -120mA$			-3	V
$V_{BE(sat)}^*$ Base-emitter saturation voltage	$I_C = -12A$ $I_B = -120mA$			-4	V
V_{BE}^* Base-emitter voltage	$I_C = -6A$ $V_{CE} = -3V$			-2.8	V
h_{FE}^* DC current gain	$I_C = -6A$ $V_{CE} = -3V$	750	18000		—
	$I_C = -12A$ $V_{CE} = -3V$	100			—
h_{fe} Small signal current gain	$I_C = -5A$ $V_{CE} = -3V$ $f = 1\ MHz$	4			—
C_{CBO} Collector-base capacitance	$V_{CB} = -10V$ $f = 1\ MHz$ $I_E = 0$			500	pF

* Pulsed: pulse duration = 300 μs , duty cycle = 1.5%

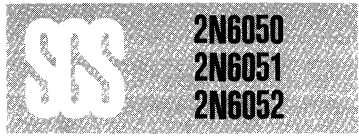

Safe operating areas for 2N6050

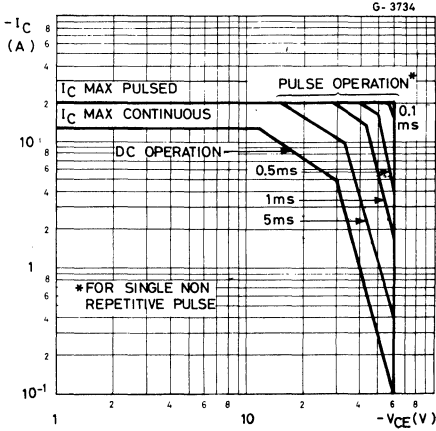

Safe operating areas for 2N6051

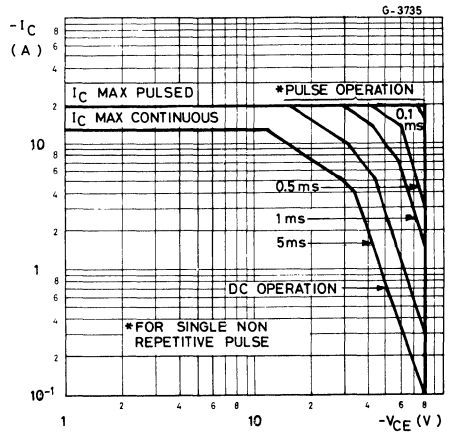

Safe operating areas for 2N6052

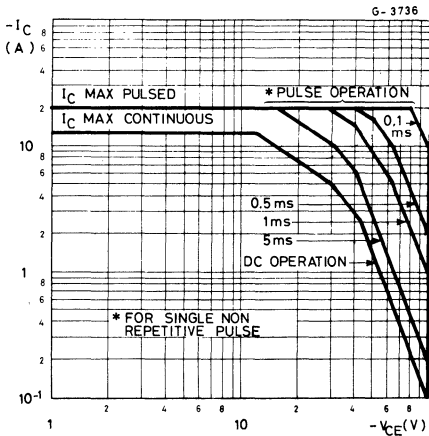

DC current gain

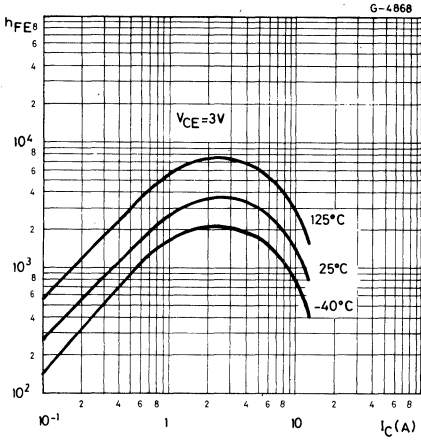

Collector-emitter saturation voltage

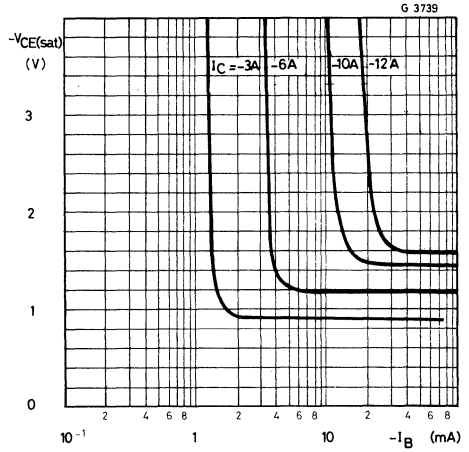

Collector-emitter saturation voltage

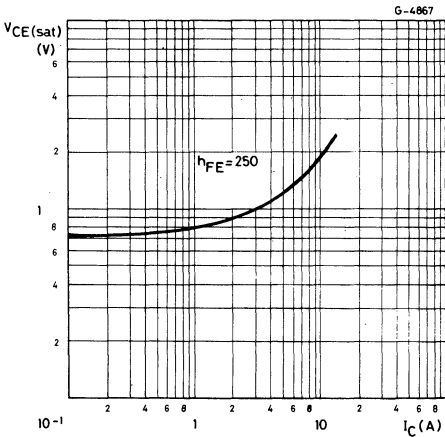

Base-emitter saturation voltage

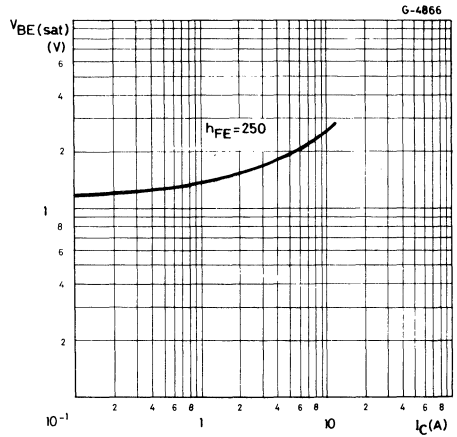



DC transconductance

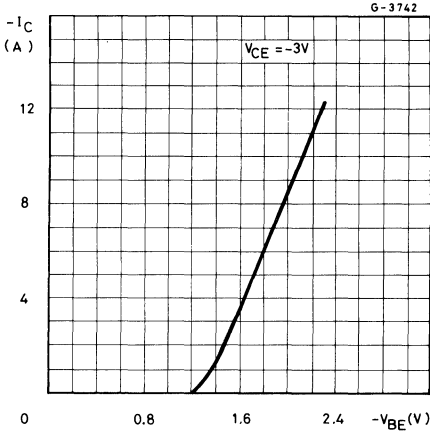

Collector-base capacitance

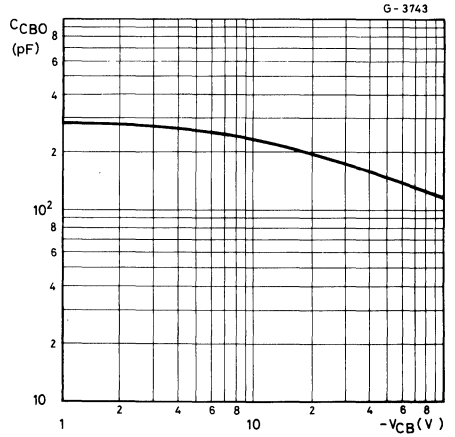

Small signal current gain

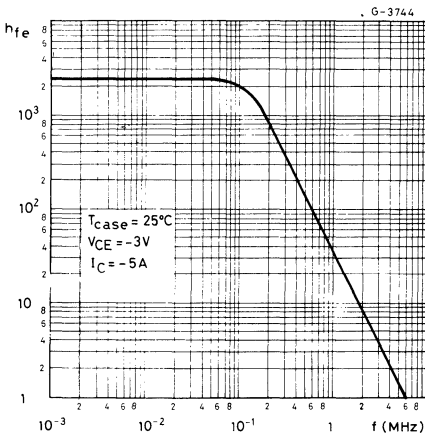

Saturated switching characteristics

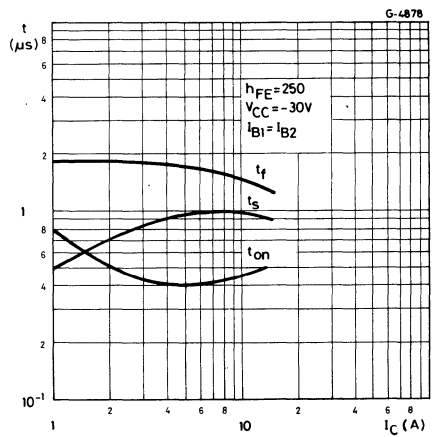



2N6053
2N6054

EPITAXIAL-BASE PNP

POWER DARLINGTONS

The 2N 6053 and 2N 6054 are silicon epitaxial-base PNP transistors in monolithic Darlington configuration and are mounted in Jedec TO-3 metal case. They are intended for use in power linear and switching applications.

The complementary NPN types are the 2N 6055 and 2N 6056 respectively.

ABSOLUTE MAXIMUM RATINGS

		2N6053	2N6054
V_{CB0}	Collector-base voltage ($I_E = 0$)	-60V	-80V
V_{CEO}	Collector-emitter voltage ($I_B = 0$)	-60V	-80V
V_{EBO}	Emitter-base voltage ($I_C = 0$)		-5V
I_C	Collector current		-8A
I_{CM}	Collector peak current		-16A
I_B	Base current		-120mA
P_{tot}	Total power dissipation at $T_{case} \leq 25^\circ C$		100W
T_{stg}	Storage temperature		-65 to 200°C
T_j	Junction temperature		200°C

INTERNAL SCHEMATIC DIAGRAM

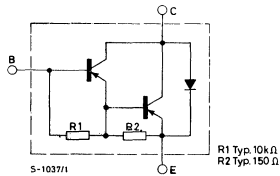

MECHANICAL DATA

Dimensions in mm

Collector connected to case

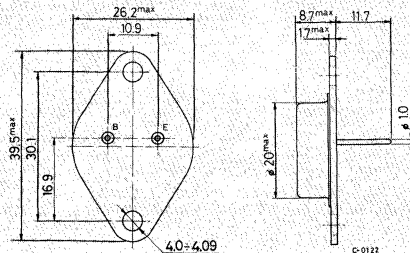

TO-3



THERMAL DATA

$R_{th\ j-case}$	Thermal resistance junction-case	max	1.75 °C/W
------------------	----------------------------------	-----	-----------

ELECTRICAL CHARACTERISTICS ($T_{case} = 25^{\circ}C$ unless otherwise specified)

Parameter	Test conditions	Min.	Typ.	Max.	Unit
I_{CEX}	Collector cutoff current ($V_{BE} = 1.5V$) for 2N6053 $V_{CE} = -60V$ for 2N6054 $V_{CE} = -80V$ $T_{case} = 150^{\circ}C$ for 2N6053 $V_{CE} = -60V$ for 2N6054 $V_{CE} = -80V$	-500		-500	μA μA mA mA
I_{CEO}	Collector cutoff current ($I_B = 0$) for 2N6053 $V_{CE} = -30V$ for 2N6054 $V_{CE} = -40V$	-0.5		-0.5	mA mA
I_{EBO}	Emitter cutoff current ($I_C = 0$) $V_{EB} = -5V$			-2	mA
$V_{CEO(sus)}^*$	Collector-emitter sustaining voltage ($I_B = 0$) $I_C = -100mA$ for 2N6053 for 2N6054	-60		-80	V V
$V_{CE(sat)}^*$	Collector-emitter saturation voltage $I_C = -4A$ $I_B = -16mA$ $I_C = -8A$ $I_B = -80mA$			-2 -3	V V
$V_{BE(sat)}^*$	Base-emitter saturation voltage $I_C = -8A$ $I_B = -80mA$			-4	V
V_{BE}^*	Base-emitter voltage $I_C = -4A$ $V_{CE} = -3V$			-2.8	V
h_{FE}^*	DC current gain $I_C = -4A$ $V_{CE} = -3V$ $I_C = -8A$ $V_{CE} = -3V$	750	18000		— —
h_{fe}	Small signal current gain $I_C = -3A$ $V_{CE} = -3V$ $f = 1\ MHz$	4			—
C_{CBO}	Collector-base capacitance $V_{CB} = -10V$ $f = 1\ MHz$ $I_E = 0$			300	pF

* Pulsed: pulse duration = 300 μs , duty cycle = 1.5%



2N6053
2N6054

Safe operating areas

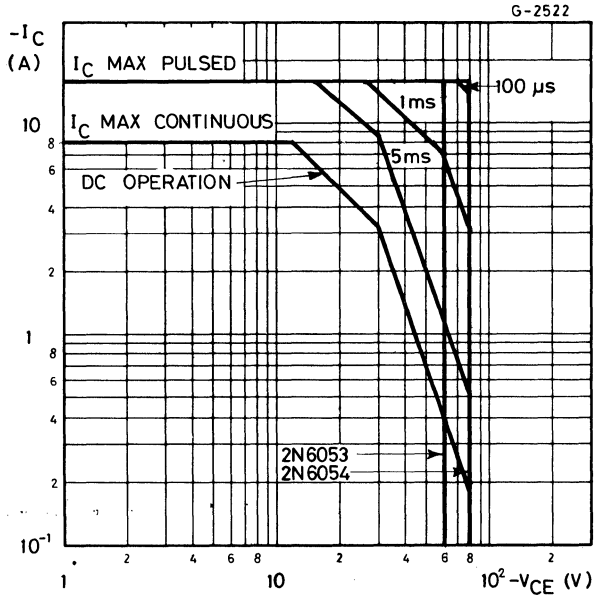

DC current gain

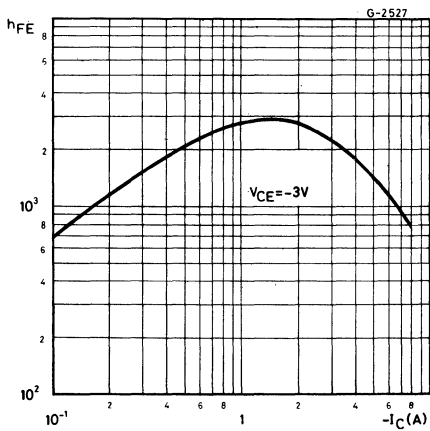

DC transconductance

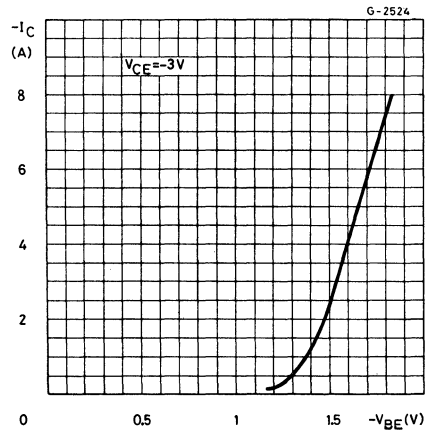



Collector-emitter saturation voltage

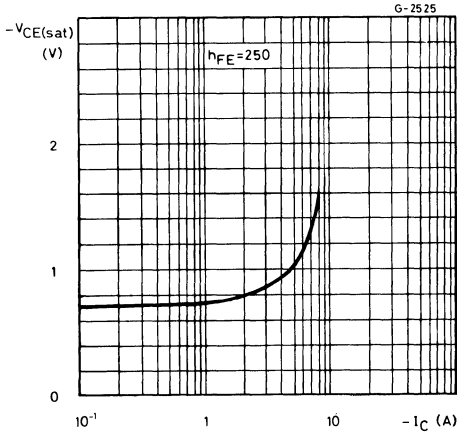

Collector-emitter saturation voltage

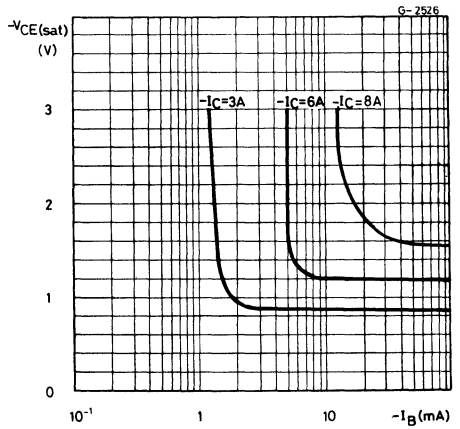

Collector-base capacitance

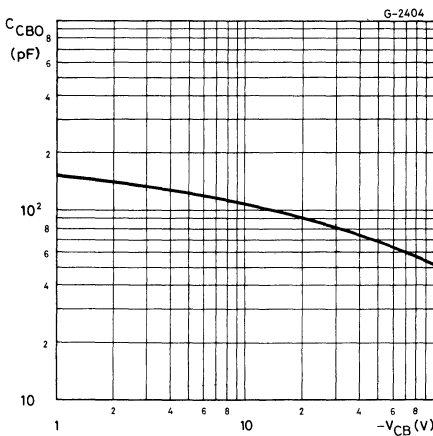

Small signal current gain

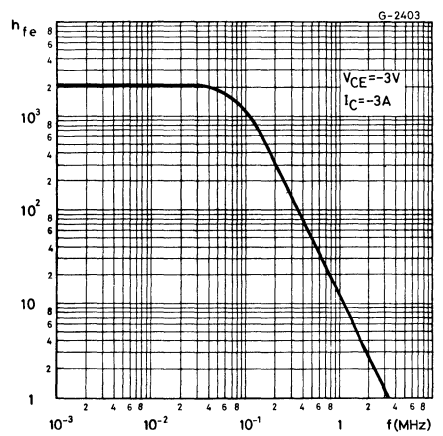



2N6055
2N6056

EPITAXIAL-BASE NPN

POWER DARLINGTONS

The 2N 6055 and 2N 6056 are silicon epitaxial-base NPN transistors in monolithic Darlington configuration and are mounted in Jedec TO-3 metal case intended for use in power linear and switching applications.

The complementary PNP types are the 2N 6053 and 2N 6054 respectively.

ABSOLUTE MAXIMUM RATINGS

		2N6055	2N6056
V_{CBO}	Collector-base voltage ($I_E = 0$)	60V	80V
V_{CEO}	Collector-emitter voltage ($I_B = 0$)	60V	80V
V_{EBO}	Emitter-base voltage ($I_C = 0$)		5V
I_C	Collector current		8A
I_{CM}	Collector peak current		16A
I_B	Base current		120mA
P_{tot}	Total power dissipation at $T_{case} \leq 25^\circ C$		100W
T_{stg}	Storage temperature		-65 to 200°C
T_j	Junction temperature		200°C

INTERNAL SCHEMATIC DIAGRAM

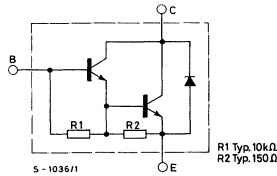

MECHANICAL DATA

Dimensions in mm

Collector connected to case

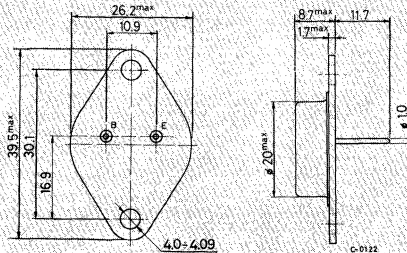

TO-3



THERMAL DATA

$R_{th\ j-case}$	Thermal resistance junction-case	max	1.75 °C/W
------------------	----------------------------------	-----	-----------

ELECTRICAL CHARACTERISTICS ($T_{case} = 25^{\circ}C$ unless otherwise specified)

Parameter	Test conditions	Min.	Typ.	Max.	Unit
I_{CEX}	Collector cutoff current ($V_{BE} = -1.5V$)	for 2N6055 for 2N6056 $T_{case} = 150^{\circ}C$ for 2N6055 for 2N6056	$V_{CE} = 60V$ $V_{CE} = 80V$ $V_{CE} = 60V$ $V_{CE} = 80V$	500 500 5 5	μA μA mA mA
I_{CEO}	Collector cutoff current ($I_B = 0$)	for 2N6055 for 2N6056	$V_{CE} = 30V$ $V_{CE} = 40V$	0.5 0.5	mA mA
I_{EBO}	Emitter cutoff current ($I_C = 0$)	$V_{EB} = 5V$		2	mA
$V_{CEO(sus)}^*$	Collector-emitter sustaining voltage ($I_B = 0$)	$I_C = 100mA$	for 2N6055 for 2N6056	60 80	V V
$V_{CE(sat)}^*$	Collector-emitter saturation voltage	$I_C = 4A$ $I_C = 8A$	$I_B = 16mA$ $I_B = 80mA$	2 3	V V
$V_{BE(sat)}^*$	Base-emitter saturation voltage	$I_C = 8A$	$I_B = 80mA$	4	V
V_{BE}^*	Base-emitter voltage	$I_C = 4A$	$V_{CE} = 3V$	2.8	V
h_{FE}^*	DC current gain	$I_C = 4A$ $I_C = 8A$	$V_{CE} = 3V$ $V_{CE} = 3V$	750 100	18000 —
h_{fe}	Small signal current gain	$I_C = 3A$ $f = 1\ MHz$	$V_{CE} = 3V$	4	—
C_{CBO}	Collector-base capacitance	$V_{CB} = 10V$ $f = 1\ MHz$	$I_E = 0$	200	pF

* Pulsed: pulse duration = 300 μs , duty cycle = 1.5%



Safe operating areas

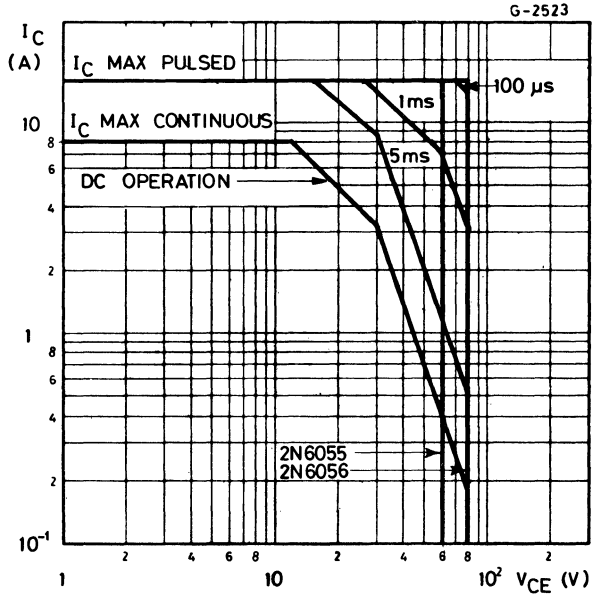

DC current gain

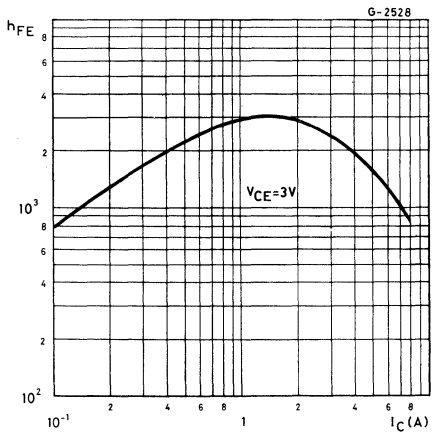

DC transconductance

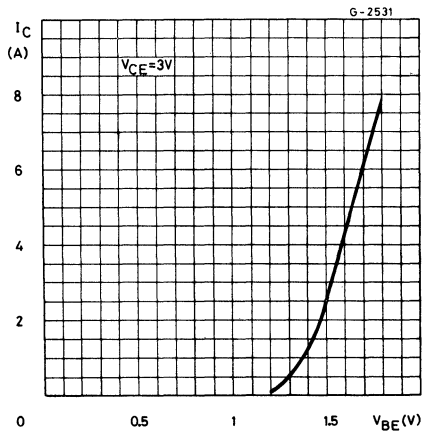



Collector-emitter saturation voltage

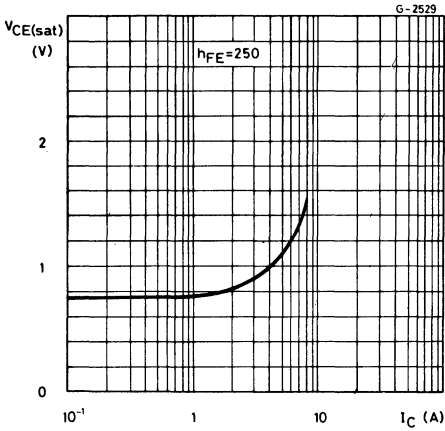

Collector-emitter saturation voltage

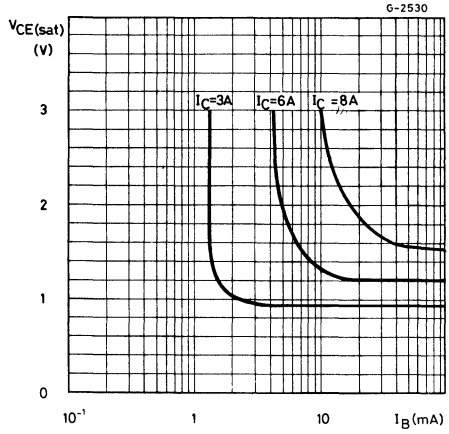

Small signal current gain

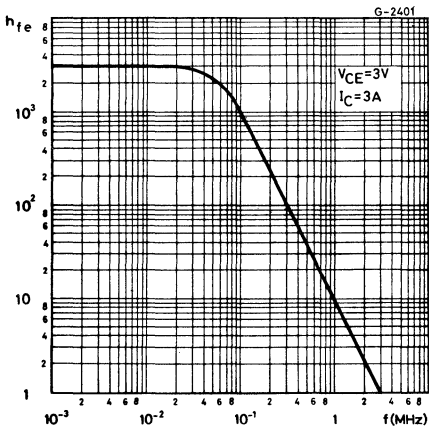

Collector-base capacitance

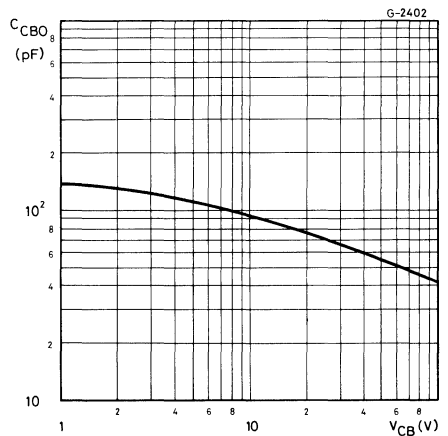

POWER DARLINGTONS

The 2N 6057, 2N 6058 and 2N 6059 are silicon epitaxial-base NPN transistor in monolithic Darlington configuration and are mounted in Jedec TO-3 metal case. They are intended for use in power linear and switching applications. The complementary PNP types are the 2N 6050, 2N 6051 and 2N 6052 respectively.

ABSOLUTE MAXIMUM RATINGS

		2N6057	2N6058	2N6059
V_{CBO}	Collector-base voltage ($I_E = 0$)	60V	80V	100V
V_{CEO}	Collector-emitter voltage ($I_B = 0$)	60V	80V	100V
V_{EBO}	Emitter-base voltage ($I_C = 0$)		5V	
I_C	Collector current		12A	
I_{CM}	Collector peak current		20A	
I_B	Base current		0.2A	
P_{tot}	Total power dissipation at $T_{case} \leq 25^\circ C$		150W	
T_{stg}	Storage temperature		-65 to 200°C	
T_j	Junction temperature		200°C	

INTERNAL SCHEMATIC DIAGRAM

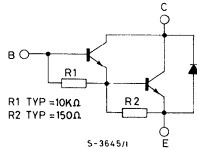

MECHANICAL DATA

Dimensions in mm

Collector connected to case

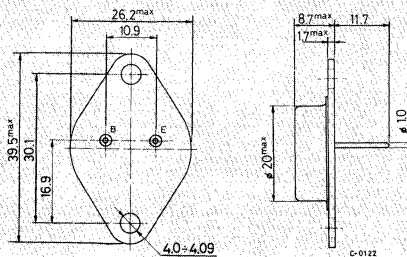

TO-3

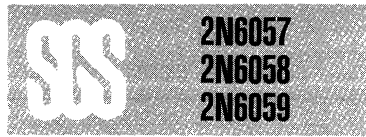

THERMAL DATA

$R_{th\ j-case}$	Thermal resistance junction-case	max 1.17 °C/W
------------------	----------------------------------	---------------

ELECTRICAL CHARACTERISTICS ($T_{case} = 25^{\circ}C$ unless otherwise specified)

Parameter	Test conditions	Min.	Typ.	Max.	Unit
I_{CEO}	Collector cutoff current ($I_B=0$)	for 2N6057 for 2N6058 for 2N6059	$V_{CE}=30V$ $V_{CE}=40V$ $V_{CE}=50V$	1 1 1	mA mA mA
I_{CEX}	Collector cutoff current ($V_{BE}=0$)	for 2N6057 for 2N6058 for 2N6059	$V_{CE}=60V$ $V_{CE}=80V$ $V_{CE}=100V$ $T_{case}=150^{\circ}C$	0.5 0.5 0.5	mA mA mA
I_{EBO}	Emitter cutoff current ($I_C=0$)	$V_{EB}=5V$		2	mA
$V_{CEO(sus)}$	*Collector-emitter sustaining voltage ($I_B = 0$)	$I_C = 100mA$ for 2N6057 for 2N6058 for 2N6059		60 80 100	V V V
$V_{CE(sat)}$	* Collector-emitter saturation voltage	$I_C = 6A$ $I_C = 12A$	$I_B = 24mA$ $I_B = 120mA$	2 3	V V
$V_{BE(sat)}$	* Base-emitter saturation voltage	$I_C = 12A$	$I_B = 120mA$	4	V
V_{BE}	* Base-emitter voltage	$I_C = 6A$	$V_{CE}=3V$	2.8	V
h_{FE}	* DC current gain	$I_C = 6A$ $I_C = 12A$	$V_{CE}=3V$ $V_{CE}=3V$	750 100	18000 —
h_{fe}	Small signal current gain	$I_C = 5A$ $f = 1MHz$	$V_{CE}=3V$	4	—
C_{CBO}	Collector-base capacitance	$V_{CB}=10V$ $f = 1MHz$	$I_E=0$	300	pF

* Pulsed: pulse duration = 300 μs , duty cycle $\leq 1.5\%$



Safe operating areas for 2N6057

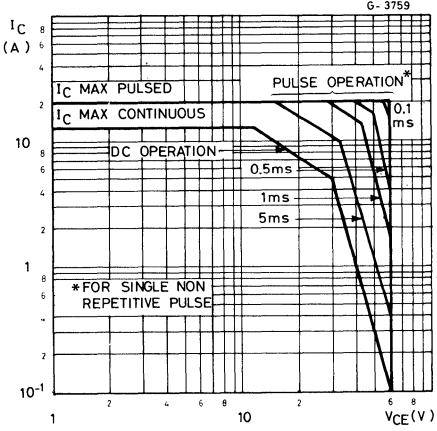

Safe operating areas for 2N6058

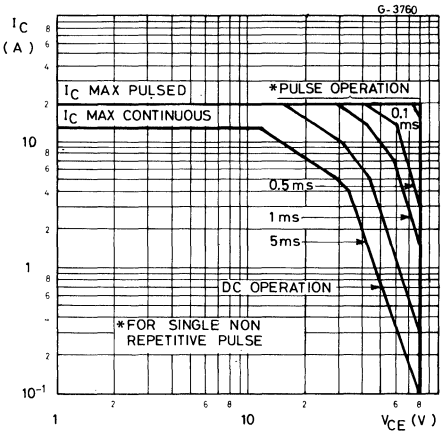

Safe operating areas for 2N6059

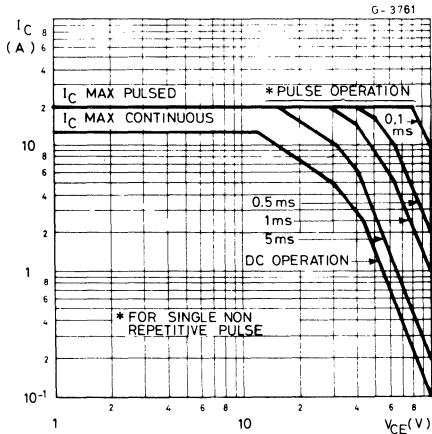

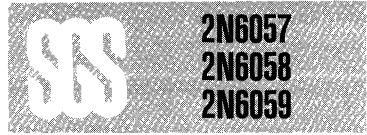

DC current gain

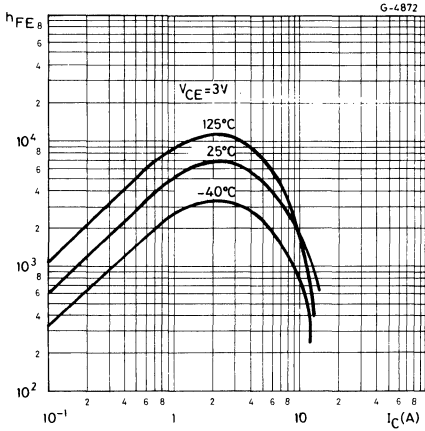

Collector-emitter saturation voltage

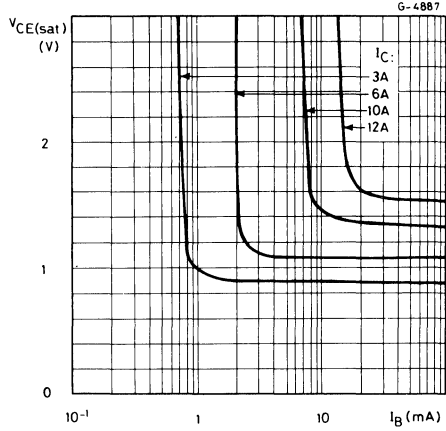

Collector-emitter saturation voltage

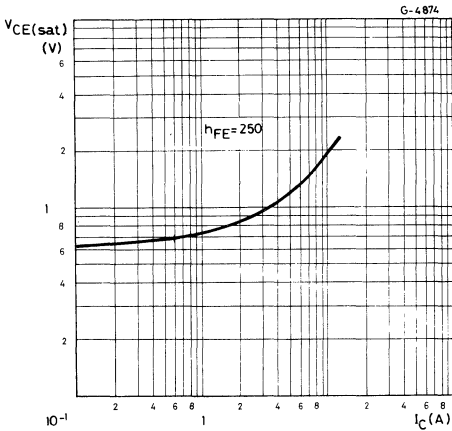

Base-emitter saturation voltage

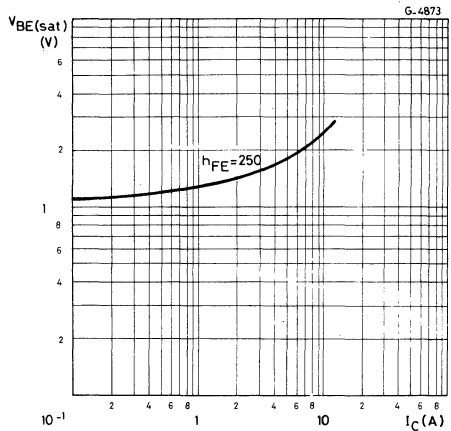



2N6057
2N6058
2N6059

DC transconductance

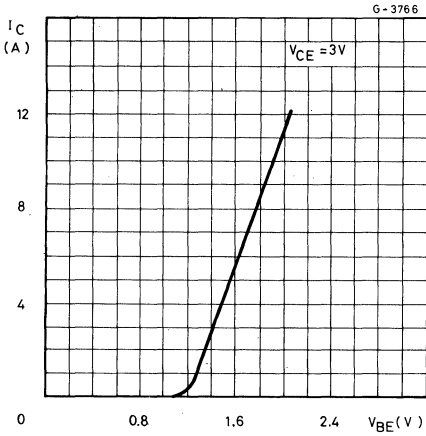

Collector-emitter saturation voltage

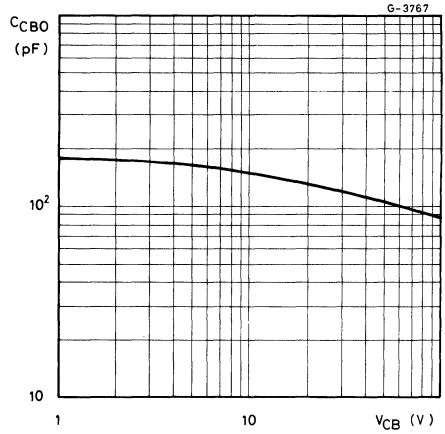

Small signal current gain

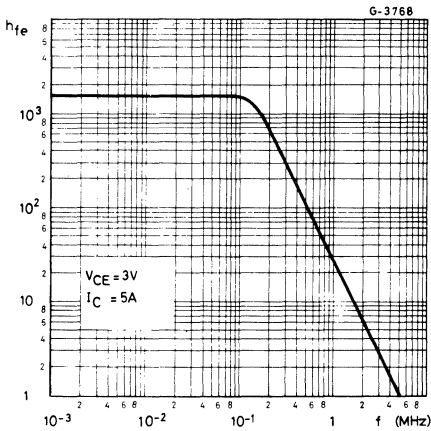

Saturated switching characteristics

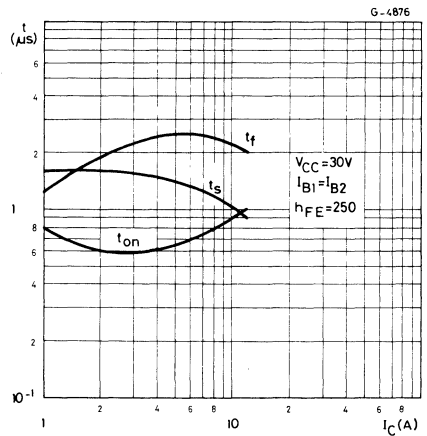

EPITAXIAL-BASE NPN/PNP



GENERAL PURPOSE COMPLEMENTARY PAIRS

The 2N 6107, 2N 6109, 2N 6111, 2N 6288, 2N 6290 and 2N 6292 are epitaxial-base silicon transistors in Jedec TO-220 plastic package. They are intended for a wide variety of medium power switching and linear applications.

The PNP types are the 2N 6107, 2N 6109, 2N 6111 and their complementary NPN types are the 2N 6292, 2N 6290 and 2N 6288 respectively.

ABSOLUTE MAXIMUM RATINGS		PNP °	2N6107	2N6109	2N6111
		NPN	2N6292	2N6290	2N6288
V_{CBO}	Collector-base voltage ($I_E = 0$)		80V	60V	40V
V_{CEX}	Collector-emitter voltage ($R_{BE} = 100\Omega$)		80V	60V	40V
V_{CEO}	Collector-emitter voltage ($I_B = 0$)		70V	50V	30V
V_{EBO}	Emitter-base voltage ($I_C = 0$)			5V	
I_C	Collector current			7A	
I_B	Base current			3A	
P_{tot}	Total power dissipation at $T_{case} \leq 25^\circ C$			40W	
T_{stg}	Storage temperature			-65 to 150 °C	
T_j	Junction temperature			150 °C	

° For PNP devices voltage and current values are negative

INTERNAL SCHEMATIC DIAGRAMS

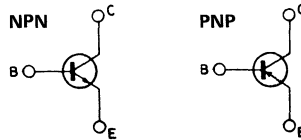

MECHANICAL DATA

Dimensions in mm

Collector connected to tab.

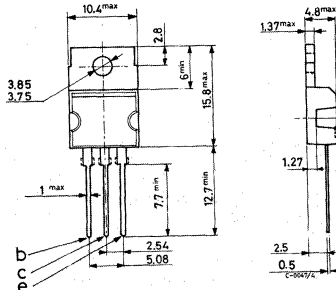

TO-220

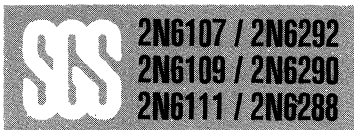

THERMAL DATA

$R_{th\ j-case}$	Thermal resistance junction-case	max 3.125 °C/W
$R_{th\ j-amb}$	Thermal resistance junction-ambient	max 70 °C/W

ELECTRICAL CHARACTERISTICS° ($T_{case} = 25\text{ °C}$ unless otherwise specified)

Parameter	Test conditions			2N6111	2N6109	2N6107	PNP
	$V_{CE}(V)$	$I_C(A)$	$I_B(A)$	2N6288	2N6290	2N6292	NPN
				Min. Max.	Min. Max.	Min. Max.	Unit
I_{CEX} ($V_{EB} = 1.5\text{ V}$)	80			0.1	0.1	0.1	mA
	60						
$T_{case} = 150\text{ °C}$	70			2	2	2	
	50						
	30						
I_{CEO} ($I_B = 0$)	60			1	1	1	mA
	40						
	20						
I_{EBO} ($V_{EB} = 5\text{ V}$)		0		1	1	1	mA
$V_{CER(sus)}^*(R_{BE} = 100\Omega)$		0.1		40	60	80	V
$V_{CEO(sus)}^*$		0.1	0	30	50	70	V
$V_{CE(sat)}^*$		2	0.2	1	1	1	V
		2.5	0.25				
		3	0.3				
		7	3				
V_{BE}^*	4	2		1.5	1.5	1.5	V
	4	2.5					
	4	3					
	4	7					
h_{FE}^*	4	2		30 150	30 150	30 150	—
	4	2.5					
	4	3					
	4	7					
h_{fe} ($f = 50\text{ kHz}$)	4	0.5		20	20	20	—
f_T	PNP types			10	10	10	MHz
	NPN types			4	4	4	
C_{CBO} ($f = 1\text{ MHz}, V_{CB} = 10\text{ V}$)				250	250	250	pF

* Pulsed: pulse duration = 300 μs , duty cycle = 1.5%

° For PNP devices voltage and current values are negative

For characteristic curves see the BD 533 (NPN) and BD 534 (PNP) series

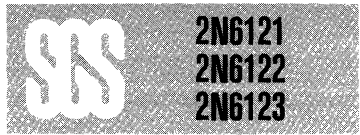

EPITAXIAL-BASE NPN

MEDIUM POWER LINEAR AND SWITCHING APPLICATIONS

The 2N 6121, 2N 6122 and 2N 6123 are silicon epitaxial-base NPN power transistors in Jedec TO-220 plastic package, intended for use in medium power linear and switching applications.

The complementary PNP types are the 2N 6124, 2N 6125 and 6126 respectively.

ABSOLUTE MAXIMUM RATINGS

		2N6121	2N6122	2N6123
V_{CBO}	Collector-base voltage ($I_E = 0$)	45V	60V	80V
V_{CES}	Collector-emitter voltage ($V_{BE} = 0$)	45V	60V	80V
V_{CEO}	Collector-emitter voltage ($I_B = 0$)	45V	60V	80V
V_{EBO}	Emitter-base voltage ($I_C = 0$)		5V	
I_C	Collector current		4A	
I_{CM}	Collector peak current		7A	
I_B	Base current		1A	
P_{tot}	Total power dissipation at $T_{case} \leq 25^\circ C$		40W	
T_{stg}	Storage temperature		-65 to 150°C	
T_j	Junction temperature		150 °C	

INTERNAL SCHEMATIC DIAGRAM

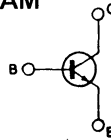

MECHANICAL DATA

Dimensions in mm

Collector connected to tab.

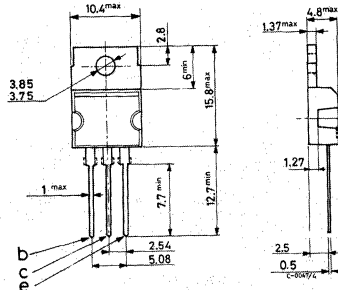

TO-220



2N6121
2N6122
2N6123

THERMAL DATA

$R_{th\ j-case}$	Thermal resistance junction-case	max	3.12	°C/W
$R_{th\ j-amb}$	Thermal resistance junction-ambient	max	70	°C/W

ELECTRICAL CHARACTERISTICS ($T_{case} = 25\ ^\circ\text{C}$ unless otherwise specified)

Parameter	Test conditions	Min.	Typ.	Max.	Unit
I_{CBO}	Collector cutoff current ($I_E = 0$)	for 2N6121 for 2N6122 for 2N6123	$V_{CB} = 45\ \text{V}$ $V_{CB} = 60\ \text{V}$ $V_{CB} = 80\ \text{V}$	100 100 100	μA μA μA
I_{CEX}	Collector cutoff current ($V_{BE} = -1.5\ \text{V}$)	for 2N6121 for 2N6122 for 2N6123	$V_{CE} = 45\ \text{V}$ $V_{CE} = 60\ \text{V}$ $V_{CE} = 80\ \text{V}$ $T_{case} = 125\ ^\circ\text{C}$	100 100 100	μA μA μA
I_{CEO}	Collector cutoff current ($I_B = 0$)	for 2N6121 for 2N6122 for 2N6123	$V_{CE} = 45\ \text{V}$ $V_{CE} = 60\ \text{V}$ $V_{CE} = 80\ \text{V}$	1 1 1	mA mA mA
I_{EBO}	Emitter cutoff current ($I_C = 0$)	$V_{EB} = 5\ \text{V}$		1	mA
$V_{CEO(sus)}$ *	Collector-emitter sustaining voltage ($I_B = 0$)	$I_C = 100\ \text{mA}$	for 2N6121 for 2N6122 for 2N6123	45 60 80	V V V
$V_{CE(sat)}$ *	Collector-emitter saturation voltage	$I_C = 1.5\ \text{A}$ $I_C = 4\ \text{A}$	$I_B = 0.15\ \text{A}$ $I_B = 1\ \text{A}$	0.6 1.4	V V
V_{BE} *	Base-emitter voltage	$I_C = 1.5\ \text{A}$	$V_{CE} = 2\ \text{V}$	1.2	V
h_{FE} *	DC current gain	$I_C = 1.5\ \text{A}$ $I_C = 4\ \text{A}$	$V_{CE} = 2\ \text{V}$ for 2N6121 for 2N6122 for 2N6123 $V_{CE} = 2\ \text{V}$ for 2N6121 for 2N6122 for 2N6123	25 25 20 10 10 7	100 100 80 — — —
h_{fe}	Small signal current gain	$I_C = 1\ \text{A}$ $f = 1\ \text{MHz}$	$V_{CE} = 4\ \text{V}$	2.5	—

* Pulsed: pulse duration = 300 μs , duty cycle = 1.5%



Safe operating areas

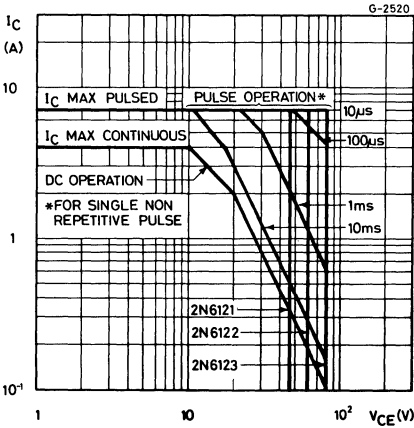

DC current gain

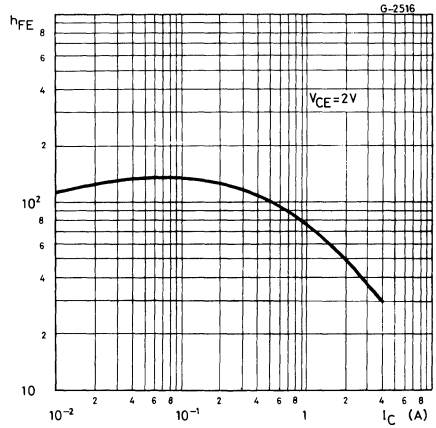

Collector-emitter saturation voltage

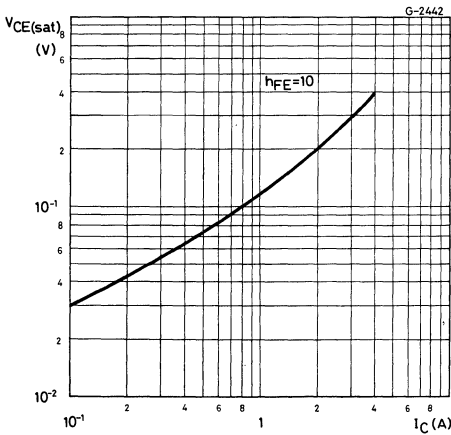

Base-emitter saturation voltage

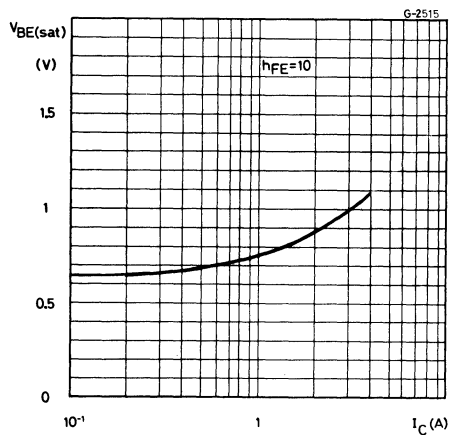

Transition frequency

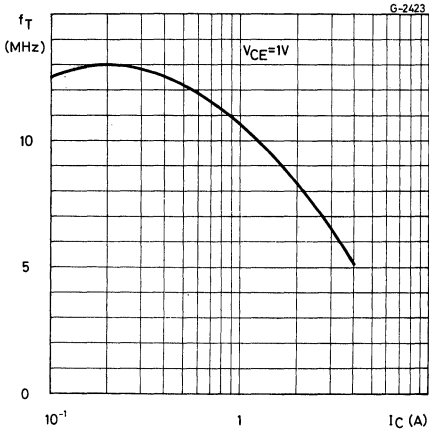

Collector-base capacitance

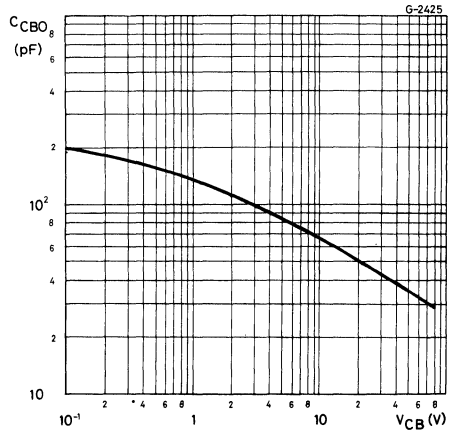

Saturated switching characteristics

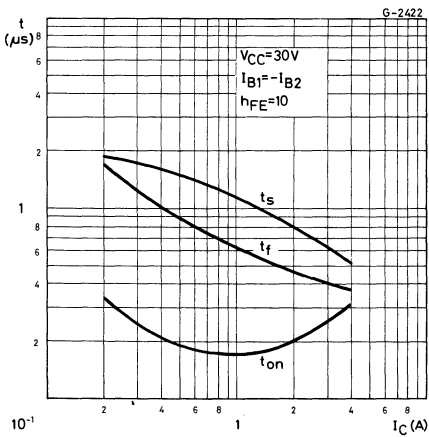

Power rating chart

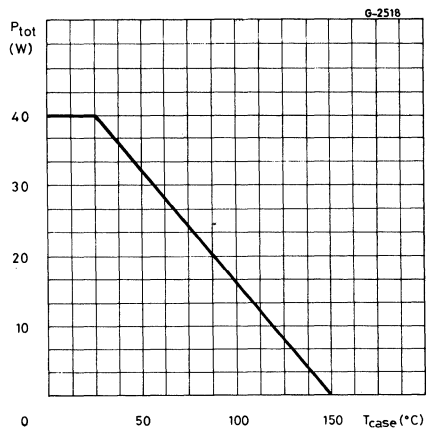

EPITAXIAL-BASE PNP



MEDIUM POWER LINEAR AND SWITCHING APPLICATIONS

The 2N 6124, 2N 6125 and 2N 6126 are silicon epitaxial-base PNP power transistors in Jedec TO-220 plastic package, intended for use in medium power linear and switching applications.

The complementary NPN types are the 2N 6121, 2N 6122 and 2N 6123 respectively.

ABSOLUTE MAXIMUM RATINGS

		2N6124	2N6125	2N6126
V_{CBO}	Collector-base voltage ($I_E = 0$)	-45V	-60V	-80V
V_{CES}	Collector-emitter voltage ($V_{BE} = 0$)	-45V	-60V	-80V
V_{CEO}	Collector-emitter voltage ($I_B = 0$)	-45V	-60V	-80V
V_{EBO}	Emitter-base voltage ($I_C = 0$)		-5V	
I_C	Collector current		-4A	
I_{CM}	Collector peak current		-7A	
I_B	Base current		-1A	
P_{tot}	Total power dissipation $T_{case} \leq 25^\circ C$		40W	
T_{stg}	Storage temperature		-65 to 150°C	
T_j	Junction temperature		150 °C	

INTERNAL SCHEMATIC DIAGRAM

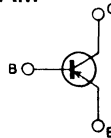

MECHANICAL DATA

Dimensions in mm

Collector connected to tab.

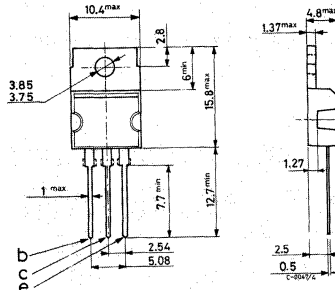

TO-220



2N6124
2N6125
2N6126

THERMAL DATA

$R_{th\ j-case}$	Thermal resistance junction-case	max	3.12	°C/W
$R_{th\ j-amb}$	Thermal resistance junction-ambient	max	70	°C/W

ELECTRICAL CHARACTERISTICS ($T_{case} = 25\text{ °C}$ unless otherwise specified)

Parameter	Test conditions	Min.	Typ.	Max.	Unit
I_{CBO}	Collector cutoff current ($I_E = 0$) for 2N6124 $V_{CB} = -45\text{ V}$ for 2N6125 $V_{CB} = -60\text{ V}$ for 2N6126 $V_{CB} = -80\text{ V}$			-100 -100 -100	μA μA μA
I_{CEX}	Collector cutoff current ($V_{BE} = 1.5\text{ V}$) for 2N6124 $V_{CE} = -45\text{ V}$ for 2N6125 $V_{CE} = -60\text{ V}$ for 2N6126 $V_{CE} = -80\text{ V}$ $T_{case} = 125\text{ °C}$ for 2N6124 $V_{CE} = -45\text{ V}$ for 2N6125 $V_{CE} = -60\text{ V}$ for 2N6126 $V_{CE} = -80\text{ V}$			-100 -100 -100 -2 -2 -2	μA μA μA mA mA mA
I_{CEO}	Collector cutoff current ($I_B = 0$) for 2N6124 $V_{CE} = -45\text{ V}$ for 2N6125 $V_{CE} = -60\text{ V}$ for 2N6126 $V_{CE} = -80\text{ V}$			-1 -1 -1	mA mA mA
I_{EBO}	Emitter cutoff current ($I_C = 0$) $V_{EB} = -5\text{ V}$			-1	mA
$V_{CEO(sus)}^*$	Collector-emitter sustaining voltage ($I_B = 0$) $I_C = -100\text{ mA}$ for 2N6124 for 2N6125 for 2N6126			-45 -60 -80	V V V
$V_{CE(sat)}^*$	Collector-emitter saturation voltage $I_C = -1.5\text{ A}$ $I_B = -0.15\text{ A}$ $I_C = -4\text{ A}$ $I_B = -1\text{ A}$			-0.6 -1.4	V V
V_{BE}^*	Base-emitter voltage $I_C = -1.5\text{ A}$ $V_{CE} = -2\text{ V}$			-1.2	V
h_{FE}^*	DC current gain $I_C = -1.5\text{ A}$ $V_{CE} = -2\text{ V}$ for 2N6124 for 2N6125 for 2N6126 $I_C = -4\text{ A}$ $V_{CE} = -2\text{ V}$ for 2N6124 for 2N6125 for 2N6126	25 25 20 10 10 7	100 100 80		— — — — — —
h_{fe}	Small signal current gain $I_C = -1\text{ A}$ $V_{CE} = -4\text{ V}$ $f = 1\text{ MHz}$	2.5			—

* Pulsed: pulse duration = 300 μs , duty cycle = 1.5%

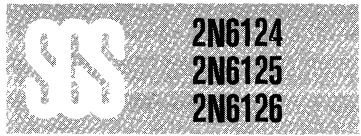

Safe operating areas

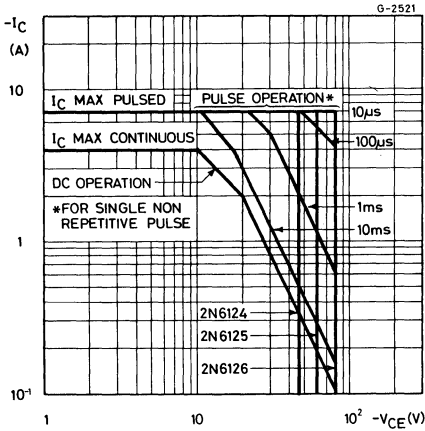

DC current gain

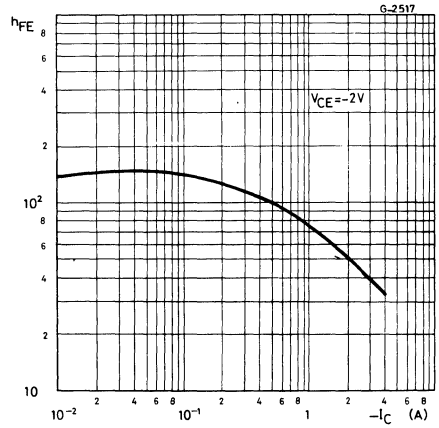

Collector-emitter saturation voltage

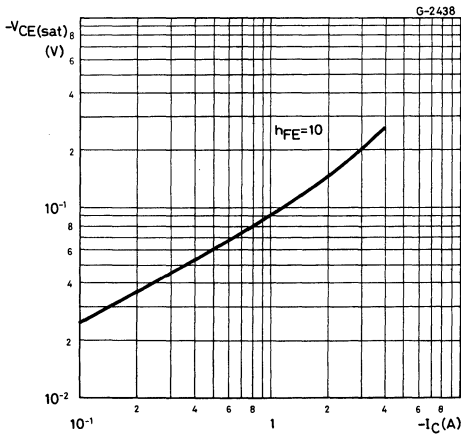

Base-emitter saturation voltage

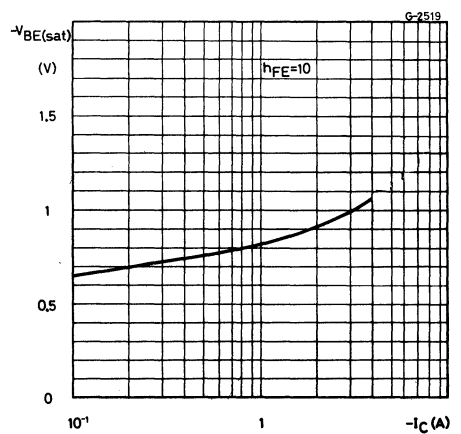

Transition frequency

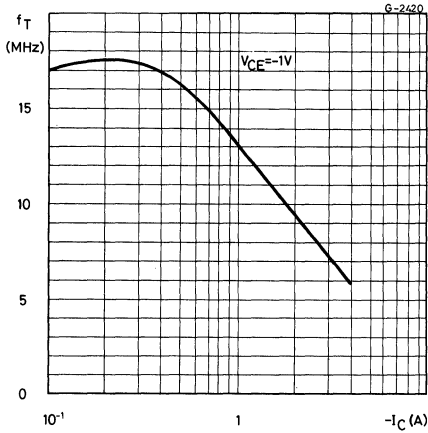

Collector-base capacitance

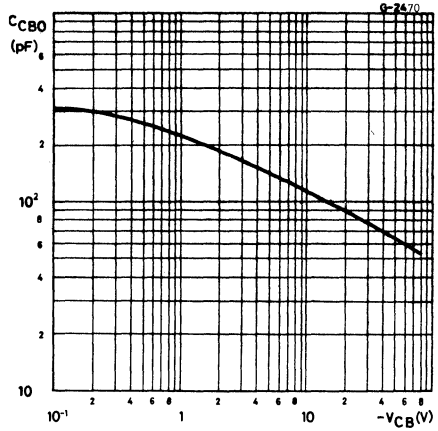

Saturated switching characteristics

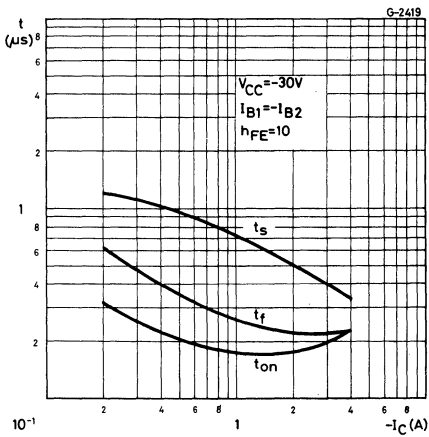

Power rating chart

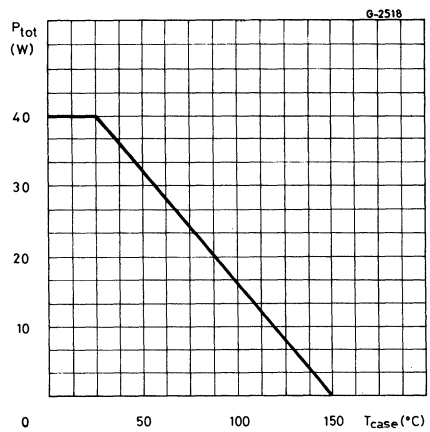



EPITAXIAL-BASE NPN/PNP

GENERAL PURPOSE AMPLIFIER AND SWITCHING APPLICATIONS

The 2N6282, 2N6283 and 2N6284 NPN types and the complementary types are mounted in jedec TO-3 metal case, intended for use in general-purpose amplifier and low-frequency switching applications. The complementary PNP types are 2N6285, 2N6286 and 2N6287.

ABSOLUTE MAXIMUM RATINGS

	NPN * PNP	2N6282 2N6285	2N6283 2N6286	2N6284 2N6287
V_{CB0}	Collector-base voltage ($I_E = 0$)	60V	80V	100V
V_{CEO}	Collector-emitter voltage ($I_B = 0$)	60V	80V	100V
V_{EBO}	Emitter-base voltage ($I_C = 0$)		5V	
I_C	Collector current		20A	
I_{CM}	Collector peak current ($t_p = 10ms$)		40A	
I_B	Base current		0.5A	
P_{tot}	Total power dissipation at $T_{case} \geq 25^\circ C$		160W	
T_{stg}	Storage temperature		-65 to 200°C	
T_j	Junction temperature		200°C	

* For PNP types voltage and current values are negative

INTERNAL SCHEMATIC DIAGRAMS

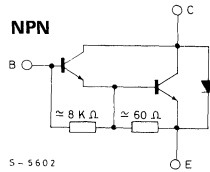
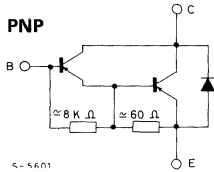

MECHANICAL DATA

Dimensions in mm

Collector connected to case

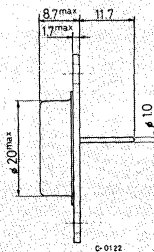
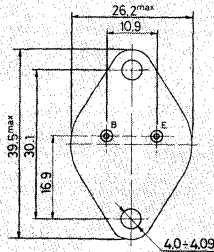

TO-3



THERMAL DATA

$R_{th\ j-case}$	Thermal resistance junction-case	max. 1.9 °C/W
------------------	----------------------------------	---------------

ELECTRICAL CHARACTERISTICS ($T_{case} = 25^{\circ}C$ unless otherwise specified)

Parameter	Test conditions	Min.	Typ.	Max.	Unit
I_{CEO}	Collector cutoff current ($I_B = 0$)	for 2N6282/85 for 2N6283/86 for 2N6284/87	$V_{CE} = 30V$ $V_{CE} = 40V$ $V_{CE} = 50V$	1 1 1	mA mA mA
I_{EBO}	Emitter cutoff current ($I_C = 0$)	$V_{BE} = 5V$		2	mA
I_{CEX}	Collector cutoff current ($V_{BE} = 1,5V$)	$V_{CE} = \text{Rated } V_{CBO}$ $V_{CE} = \text{Rated } V_{CBO}$ $T_{case} = 150^{\circ}C$		0.5 5	mA mA
$V_{CEO(sus)}^*$	Collector-emitter sustaining voltage	$I_C = 0.1A$ $I_B = 0$ for 2N6282/85 for 2N6283/86 for 2N6284/87		60 80 100	V V V
$V_{CE(sat)}^*$	Collector-emitter saturation voltage	$I_C = 10A$ $I_C = 20A$	$I_B = 40mA$ $I_B = 200mA$	2 3	V V
$V_{BE(sat)}^*$	Base-emitter saturation voltage	$I_C = 20A$	$I_B = 200mA$	4	V
$V_{BE(on)}^*$	Base-emitter voltage	$I_C = 10A$	$V_{CE} = 3V$	2.8	V
h_{FE}^*	DC current gain	$I_C = 10A$ $I_C = 20A$	$V_{CE} = 3V$ $V_{CE} = 3V$	750 100	18000 —
C_{CBO}	Collector-base capacitance	$V_{CB} = 10V$ $f = 0.1MHz$ for 2N6282/6283/6284 for 2N6285/6286/6287	$I_E = 0$		400 600 pF pF
h_{fe}	Small signal current gain	$I_C = 10A$ $f = 1KHz$	$V_{CE} = 3V$	300	—

* Pulsed: pulse duration = 300 μs , duty cycle = 2%.

For PNP types voltage and current values are negative



MULTIEPITAXIAL PLANAR NPN

HIGH SPEED SWITCHING APPLICATIONS

The 2N 6354 is a silicon planar multiepitaxial NPN transistor in Jedec TO-3 metal case. It is intended for use in high speed switching applications in military and industrial equipment.

ABSOLUTE MAXIMUM RATINGS

V_{CBO}	Collector-base voltage ($I_E = 0$)	150	V
V_{CEX}	Collector-emitter voltage ($R_{BE} = 500\Omega$)	130	V
V_{CEO}	Collector-emitter voltage ($I_B = 0$)	120	V
V_{EBO}	Emitter-base voltage ($I_C = 0$)	6.5	V
I_C	Collector current	10	A
I_{CM}	Collector peak current	12	A
I_B	Base current	5	A
P_{tot}	Total power dissipation at $T_{case} \leq 25^\circ C$	140	W
T_{stg}	Storage temperature	-65 to 200	$^\circ C$
T_j	Junction temperature	200	$^\circ C$

INTERNAL SCHEMATIC DIAGRAM

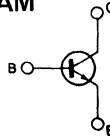

MECHANICAL DATA

Dimensions in mm

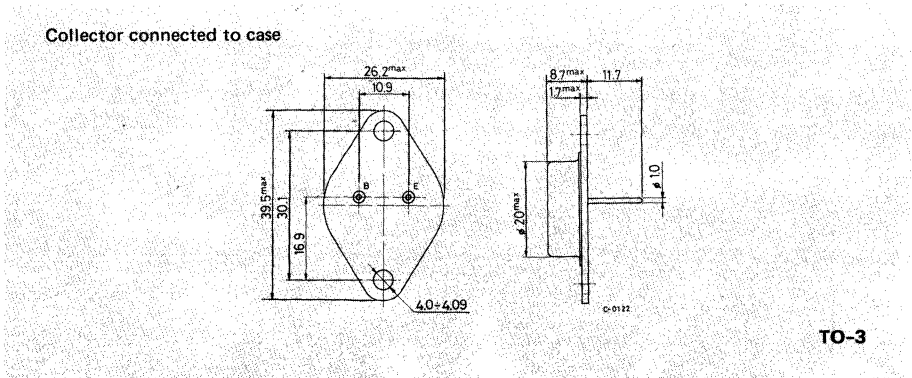



2N6354

THERMAL DATA

$R_{th\ j-case}$	Thermal resistance junction-case	max 1.25 °C/W
------------------	----------------------------------	---------------

ELECTRICAL CHARACTERISTICS ($T_{case} = 25\text{ °C}$ unless otherwise specified)

Parameter	Test conditions	Min.	Typ.	Max.	Unit	
I_{CBO}	Collector cutoff current ($I_E = 0$)	$V_{CB} = 150\text{ V}$		5	mA	
I_{CES}	Collector cutoff current ($V_{BE} = 0$)	$V_{CE} = 140\text{ V}$ $V_{CE} = 140\text{ V}$ $T_{case} = 150\text{ °C}$		10 20	mA mA	
I_{CEO}	Collector cutoff current ($I_B = 0$)	$V_{CE} = 100\text{ V}$		20	mA	
I_{EBO}	Emitter cutoff current ($I_C = 0$)	$V_{EB} = 6.5\text{ V}$		5	mA	
$V_{CEO(sus)}^*$	Collector-emitter sustaining voltage ($I_B = 0$)	$I_C = 200\text{ mA}$		120	V	
$V_{CER(sus)}^*$	Collector-emitter sustaining voltage ($R_{BE} = 100\Omega$)	$I_C = 200\text{ mA}$		130	V	
$V_{CE(sat)}^*$	Collector-emitter saturation voltage	$I_C = 10\text{ A}$ $I_C = 5\text{ A}$	$I_B = 1\text{ A}$ $I_B = 0.5\text{ A}$	1 0.5	V V	
$V_{BE(sat)}^*$	Base-emitter saturation voltage	$I_C = 10\text{ A}$ $I_C = 5\text{ A}$	$I_B = 1\text{ A}$ $I_B = 0.5\text{ A}$	2 1.3	V V	
h_{FE}^*	DC current gain	$I_C = 5\text{ A}$ $I_C = 10\text{ A}$	$V_{CE} = 2\text{ V}$ $V_{CE} = 2\text{ V}$	20 10	150 100	— —
h_{fe}	Small signal current gain	$I_C = 1\text{ A}$ $f = 10\text{ MHz}$	$V_{CE} = 10\text{ V}$	8	—	
C_{CBO}	Collector-base capacitance	$I_E = 0$ $f = 1\text{ MHz}$	$V_{CB} = 10\text{ V}$	300	pF	
t_r	Rise time	$I_C = 5\text{ A}$ $I_{B1} = -I_{B2} = 0.5\text{ A}$ $I_C = 10\text{ A}$ $I_{B1} = -I_{B2} = 1\text{ A}$	$V_{CC} = 30\text{ V}$ $V_{CC} = 30\text{ V}$	0.3 1	μs μs	

ELECTRICAL CHARACTERISTICS (continued)

Parameter	Test conditions	Min. Typ. Max.	Unit
t_s	Storage time $I_C = 5\text{ A}$ $V_{CC} = 30\text{ V}$ $I_{B1} = -I_{B2} = 0.5\text{ A}$		1 μs
t_f	Fall time $I_C = 5\text{ A}$ $V_{CC} = 30\text{ V}$ $I_{B1} = -I_{B2} = 0.5\text{ A}$	0.2	μs
$I_{s/b}^{**}$	Second breakdown collector current $V_{CE} = 25\text{ V}$	5.5	A
$E_{s/b}$	Second breakdown energy $I_C = 5\text{ A}$ $V_{EB} = 1\text{ V}$ $R_{BE} = 50\ \Omega$ $L = 25\ \mu\text{H}$	0.3	mJ

* Pulsed: pulse duration = 300 μs , duty cycle = 1.5%

** Pulsed: 1 s, non repetitive pulse

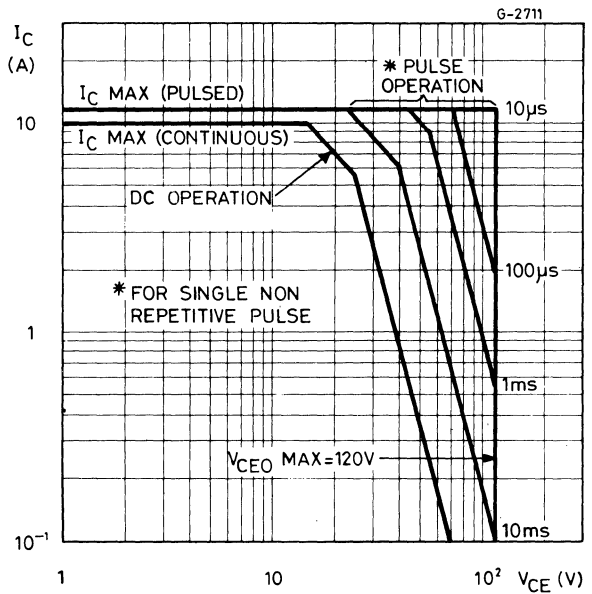
Safe operating areas



2N6354

DC current gain

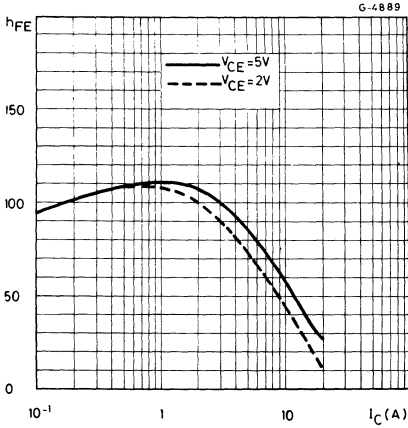

Collector-emitter saturation voltage

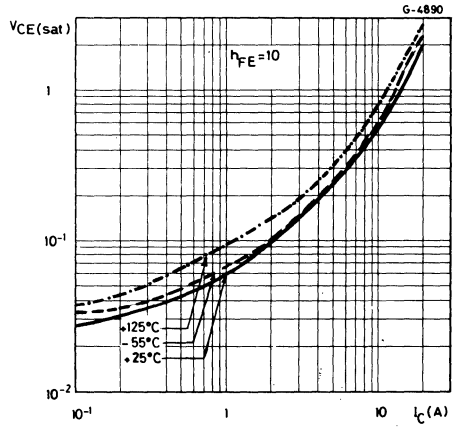

Collector-emitter saturation voltage

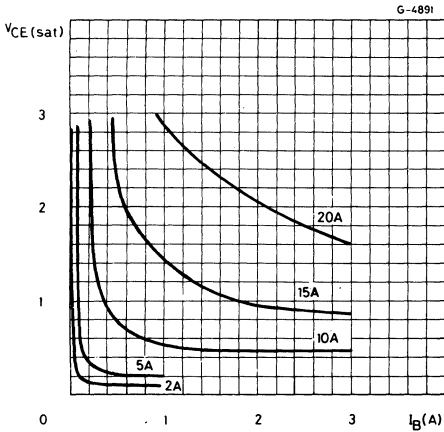

Base-emitter saturation voltage

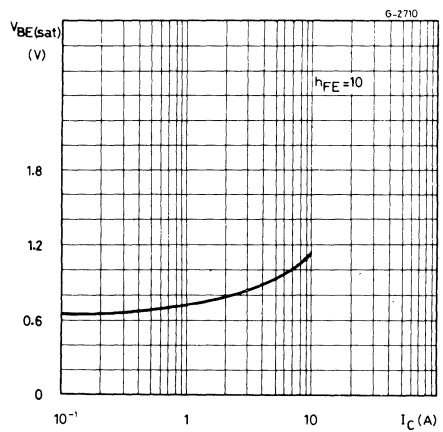

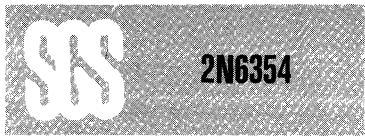

$V_{BE(on)}$ vs. collector current

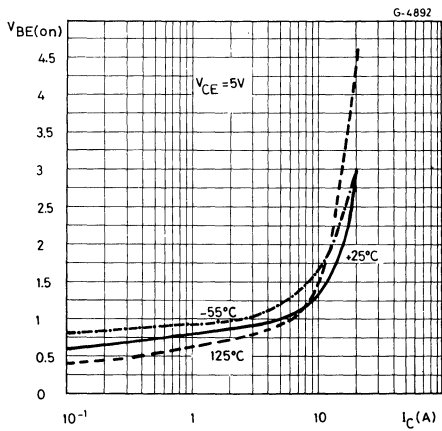

Saturated switching characteristics

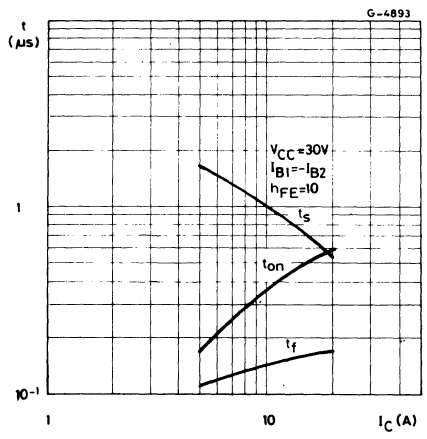

Collector-base capacitance

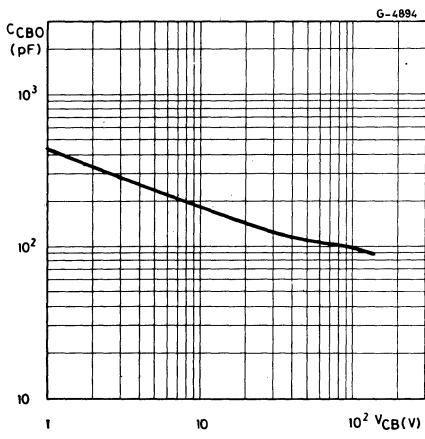

Transition frequency

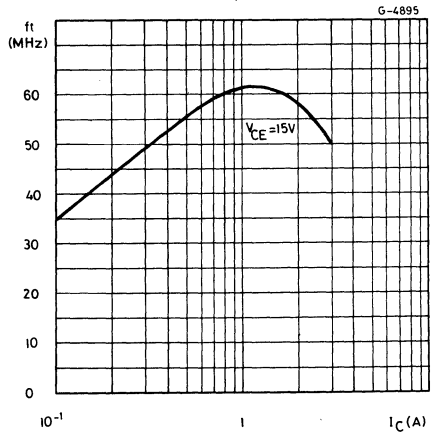



2N6386
2N6387
2N6388

EPITAXIAL-BASE NPN

POWER DARLINGTON TRANSISTORS

The 2N 6386, 2N 6387 and 2N 6388 are silicon epitaxial-base NPN transistors in monolithic Darlington configuration and are mounted in Jedec TO-220 plastic package. They are intended for use in low and medium frequency power applications.

ABSOLUTE MAXIMUM RATINGS

		2N6386	2N6387	2N6388
V_{CBO}	Collector-base voltage ($I_B = 0$)	40V	60V	80V
V_{CEV}	Collector-emitter voltage ($V_{BE} = -1.5$ V)	40V	60V	80V
V_{CER}	Collector-emitter voltage ($R_{BE} \leq 100\Omega$)	40V	60V	80V
V_{CEO}	Collector-emitter voltage ($I_B = 0$)	40V	60V	80V
V_{EBO}	Emitter-base voltage ($I_C = 0$)	5V	5V	5V
I_C	Collector current	8A	10A	10A
I_{CM}	Collector peak current		15A	
I_B	Base current		250mA	
P_{tot}	Total power dissipation at $T_{case} \leq 25^\circ C$		65W	
T_{stg}	Storage temperature		-65 to 150 °C	
T_j	Junction temperature		150 °C	

MECHANICAL DATA

Dimensions in mm

Collector connected to tab.

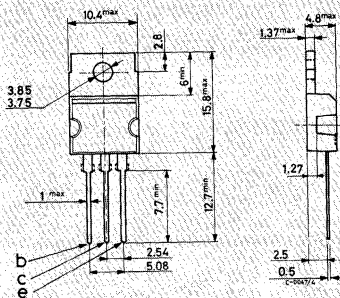

TO-220



THERMAL DATA

$R_{th\ j-case}$	Thermal resistance junction-case	max 1.92 °C/W
------------------	----------------------------------	---------------

ELECTRICAL CHARACTERISTICS ($T_{case} = 25\text{ °C}$ unless otherwise specified)

Parameter	Test conditions	Min.	Typ.	Max.	Unit	
I_{CEV} Collector cutoff current ($V_{BE} = -1.5\text{ V}$)	$V_{CE} = 40\text{ V}$ for 2N6386		0.3		mA	
	$V_{CE} = 60\text{ V}$ for 2N6387		0.3		mA	
	$V_{CE} = 80\text{ V}$ for 2N6388		0.3		mA	
	$T_{case} = 125\text{ °C}$					
	$V_{CE} = 40\text{ V}$ for 2N6386			3		mA
	$V_{CE} = 60\text{ V}$ for 2N6387			3	mA	
	$V_{CE} = 80\text{ V}$ for 2N6388			3	mA	
I_{CEO} Collector cutoff current ($I_B = 0$)	$V_{CE} = 40\text{ V}$ for 2N6386		1		mA	
	$V_{CE} = 60\text{ V}$ for 2N6387		1		mA	
	$V_{CE} = 80\text{ V}$ for 2N6388		1		mA	
I_{EBO} Emitter-base current ($I_C = 0$)	$V_{EB} = 5\text{ V}$		5		mA	
$V_{CEO(sus)}$ * Collector-emitter sustaining voltage ($I_B = 0$)	$I_C = 200\text{ mA}$	for 2N6386	40		V	
		for 2N6387	60		V	
		for 2N6388	80		V	
$V_{CER(sus)}$ * Collector-emitter sustaining voltage ($R_{BE} = 100\ \Omega$)	$I_C = 200\text{ mA}$	for 2N6386	40		V	
		for 2N6387	60		V	
		for 2N6388	80		V	
$V_{CEV(sus)}$ * Collector-emitter sustaining voltage ($V_{BE} = -1.5\text{ V}$)	$I_C = 200\text{ mA}$	for 2N6386	40		V	
		for 2N6387	60		V	
		for 2N6388	80		V	
$V_{CE(sat)}$ * Collector-emitter saturation voltage	for 2N6386		2		V	
	$I_C = 3\text{ A}$ $I_B = 6\text{ mA}$					
	for 2N6387 and 2N6388		2		V	
	$I_C = 5\text{ A}$ $I_B = 10\text{ mA}$					
	for 2N6386		3		V	
$I_C = 8\text{ A}$ $I_B = 80\text{ mA}$						
for 2N6387 and 2N6388		3		V		
$I_C = 10\text{ A}$ $I_B = 100\text{ mA}$						



2N6386
2N6387
2N6388

ELECTRICAL CHARACTERISTICS (continued)

Parameter	Test conditions	Min.	Typ.	Max.	Unit
V_{BE}^* Base-emitter voltage	for 2N6386 $I_C = 3\text{ A}$ $V_{CE} = 3\text{ V}$		2.8		V
	for 2N6387 and 2N6388 $I_C = 5\text{ A}$ $V_{CE} = 3\text{ V}$		2.8		V
	for 2N6386 $I_C = 8\text{ A}$ $V_{CE} = 3\text{ V}$		4.5		V
	for 2N6387 and 2N6388 $I_C = 10\text{ A}$ $V_{CE} = 3\text{ V}$		4.5		V
h_{FE}^* DC current gain	for 2N6386 $I_C = 3\text{ A}$ $V_{CE} = 3\text{ V}$	1000		20000	—
	for 2N6387 and 2N6388 $I_C = 5\text{ A}$ $V_{CE} = 3\text{ V}$	1000		20000	—
	for 2N6386 $I_C = 8\text{ A}$ $V_{CE} = 3\text{ V}$	100			—
	for 2N6387 and 2N6388 $I_C = 10\text{ A}$ $V_{CE} = 3\text{ V}$	100			—
h_{fe} Small signal current gain	$I_C = 1\text{ A}$ $V_{CE} = 10\text{ V}$ $f = 1\text{ MHz}$ $V_{CE} = 10\text{ V}$ $f = 1\text{ kHz}$	20		1000	— —
V_F^* Paralled-diode forward voltage	for 2N6386 $I_F = 8\text{ A}$		4		V
	for 2N6387 and 2N6388 $I_F = 10\text{ A}$		4		V
C_{CBO} Collector-base capacitance	$I_E = 0$ $V_{CB} = 10\text{ V}$ $f = 1\text{ MHz}$		200		pF
$I_{s/b}^{**}$ Second breakdown collector current	$V_{CE} = 25\text{ V}$	2.6			A
$E_{s/b}$ Second breakdown energy	$L = 12\text{ mH}$ $R_{BE} = 100\Omega$ $V_{BE} = -1.5\text{ V}$ $I_C = 4.5\text{ A}$	120			mJ

* Pulsed: pulse duration = 300 μs , duty cycle = 1.5%

** Pulsed: 1s non repetitive pulse

EPITAXIAL-BASE NPN



POWER LINEAR AND SWITCHING APPLICATIONS

The 2N6486, 2N6487 and 2N6488 are silicon epitaxial-base NPN transistors mounted in Jedec TO-220 plastic package. They are intended for use in power linear and switching applications. The complementary PNP types are the 2N6489, 2N6490 and 2N6491 respectively.

ABSOLUTE MAXIMUM RATINGS

		2N6486	2N6487	2N6488
V_{CBO}	Collector-base voltage ($I_E = 0$)	50V	70V	90V
V_{CEX}	Collector-base voltage ($V_{BE} = 1.5V$; $R_{BE} = 100\Omega$)	50V	70V	90V
V_{CEO}	Collector-base voltage ($I_B = 0$)	40V	60V	80V
V_{EBO}	Emitter-base voltage ($I_C = 0$)		5V	
I_C	Collector-current		15A	
I_B	Base-current		5A	
P_{tot}	Total power dissipation at $T_{case} \leq 25^\circ C$ $T_{amb} \leq 25^\circ C$		75W	
T_{stg}	Storage temperature		1.8W	
T_j	Junction temperature		-65 to 150°C	150°C

INTERNAL SCHEMATIC DIAGRAM

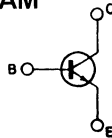

MECHANICAL DATA

Dimensions in mm

Collector connected to tab.

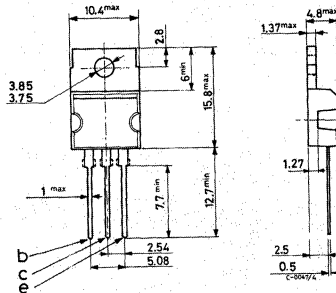

TO-220



2N6486
2N6487
2N6488

HERMAL DATA

$R_{th\ j-case}$	Thermal resistance junction-case	max	1.67	°C/W
$R_{th\ j-amb}$	Thermal resistance junction-ambient	max	70	°C/W

ELECTRICAL CHARACTERISTICS ($T_{case} = 25^{\circ}C$ unless otherwise specified)

Parameter	Test conditions	Min.	Typ.	Max.	Unit
I_{CEO}	Collector-cutoff current ($I_B = 0$)	for 2N6486 for 2N6487 for 2N6488	$V_{CE} = 20V$ $V_{CE} = 30V$ $V_{CE} = 40V$	1 1 1	mA mA mA
I_{CEX}	Collector-cutoff current ($V_{BE} = -1.5V$, $R_{BE} = 100\Omega$)	for 2N6486 for 2N6487 for 2N6488	$V_{CE} = 45V$ $V_{CE} = 65V$ $V_{CE} = 85V$ $T_{case} = 150^{\circ}C$	0.5 0.5 0.5	mA mA mA
I_{CER}	Collector-cutoff current ($R_{BE} = 100\Omega$)	for 2N6486 for 2N6487 for 2N6488	$V_{CE} = 40V$ $V_{CE} = 60V$ $V_{CE} = 80V$	5 5 5	mA mA mA
I_{CER}	Collector-cutoff current ($R_{BE} = 100\Omega$)	for 2N6486 for 2N6487 for 2N6488	$V_{CE} = 35V$ $V_{CE} = 55V$ $V_{CE} = 75V$	0.5 0.5 0.5	mA mA mA
I_{EBO}	Emitter-cutoff current ($I_C = 0$)	$V_{BE} = 5V$		1	mA
$V_{CEO(sus)}$	*Collector-emitter sustaining voltage ($I_B = 0$)	$I_C = 200mA$ for 2N6486 for 2N6487 for 2N6488		40 60 80	V V V
$V_{CER(sus)}$	*Collector-emitter sustaining voltage ($R_{BE} = 100\Omega$)	$I_C = 200mA$ for 2N6486 for 2N6487 for 2N6488		45 65 85	V V V

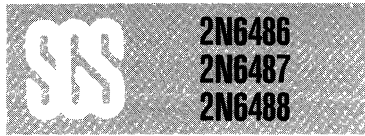

ELECTRICAL CHARACTERISTICS (continued)

Parameter	Test conditions	Min.	Typ.	Max.	Unit
$V_{CEX(sus)}$ * Collector-emitter sustaining voltage ($V_{BE} = -1.5V$; $R_{BE} = 100\Omega$)	$I_C = 200mA$ for 2N6486 for 2N6487 for 2N6488	50 70 90			V V V
$V_{CE(sat)}$ * Collector-emitter saturation voltage	$I_C = 5A$ $I_B = 0.5A$ $I_C = 15A$ $I_B = 5A$			1.3 3.5	V V
V_{BE} * Base-emitter voltage	$I_C = 5A$ $V_{CE} = 4V$ $I_C = 15A$ $V_{CE} = 4V$			1.3 3.5	V V
h_{FE} * DC current gain	$I_C = 5A$ $V_{CE} = 4V$ $I_C = 15A$ $V_{CE} = 4V$	20 5		150	— —
h_{fe} Small signal current gain	$I_C = 1A$ $V_{CE} = 4V$ $f = 1MHz$ $I_C = 1A$ $V_{CE} = 4V$ $f = 1KHz$	5 25			— —

* Pulsed: pulse duration = $300\mu s$, duty cycle $\leq 2\%$.

POWER LINEAR AND SWITCHING APPLICATIONS

The 2N6489, 2N6490 and 2N6491 are silicon epitaxial-base PNP transistors mounted in Jedec TO-220 plastic package.

They are intended for use in power linear and switching applications.

The complementary NPN types are the 2N6486, 2N6487 and 2N6488 respectively.

ABSOLUTE MAXIMUM RATINGS

		2N6489	2N6490	2N6491
V_{CBO}	Collector-base voltage ($I_E = 0$)	-50V	-70V	-90V
V_{CEX}	Collector-base voltage ($V_{BE} = 1.5V$; $R_{BE} = 100\Omega$)	-50V	-70V	-90V
V_{CEO}	Collector-base voltage ($I_B = 0$)	-40V	-60V	-80V
V_{EBO}	Emitter-base voltage ($I_C = 0$)		-5V	
I_C	Collector-current		-15A	
I_B	Base-current		-5A	
P_{tot}	Total power dissipation at $T_{case} \leq 25^\circ C$ $T_{amb} \leq 25^\circ C$		75W 1.8W	
T_{stg}	Storage temperature		-65 to 150°C	
T_j	Junction temperature		150°C	

INTERNAL SCHEMATIC DIAGRAM

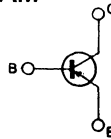

MECHANICAL DATA

Dimensions in mm

Collector connected to tab.

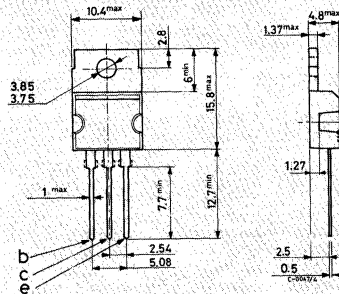

TO-220



THERMAL DATA

$R_{th\ j-case}$	Thermal resistance junction-case	max	1.67	°C/W
$R_{th\ j-amb}$	Thermal resistance junction-ambient	max	70	°C/W

ELECTRICAL CHARACTERISTICS ($T_{case} = 25^{\circ}C$ unless otherwise specified)

Parameter	Test conditions	Min.	Typ.	Max.	Unit
I_{CEO} Collector-cutoff current ($I_B = 0$)	for 2N6489 $V_{CE} = -20V$ for 2N6490 $V_{CE} = -30V$ for 2N6491 $V_{CE} = -40V$			-1	mA
I_{CEX} Collector-cutoff current ($V_{BE} = 1.5V$, $R_{BE} = 100\Omega$)	for 2N6489 $V_{CE} = -45V$			-0.5	mA
	for 2N6490 $V_{CE} = -65V$			-0.5	mA
	for 2N6491 $V_{CE} = -85V$			-0.5	mA
	for 2N6489 $V_{CE} = -40V$			-5	mA
	for 2N6490 $V_{CE} = -60V$			-5	mA
	for 2N6491 $V_{CE} = -80V$			-5	mA
I_{CER} Collector cutoff current ($R_{BE} = 100\Omega$)	for 2N6489 $V_{CE} = -35V$			-0.5	mA
	for 2N6490 $V_{CE} = -55V$			-0.5	mA
	for 2N6491 $V_{CE} = -75V$			-0.5	mA
I_{EBO} Emitter-cutoff current	$V_{BE} = -5V$			-1	mA
$V_{CEO(sus)}$ *Collector-emitter sustaining voltage ($I_B = 0$)	$I_C = -200mA$ for 2N6489 for 2N6490 for 2N6491			-40	V
				-60	V
				-80	V
$V_{CER(sus)}$ *Collector-emitter sustaining voltage ($R_{BE} = 100\Omega$)	$I_C = -200mA$ for 2N6489 for 2N6490 for 2N6491			-45	V
				-65	V
				-85	V



2N6489
2N6490
2N6491

ELECTRICAL CHARACTERISTICS (continued)

Parameter	Test conditions	Min.	Typ.	Max.	Unit
$V_{CEX(sus)}$ * Collector-emitter sustaining voltage ($V_{BE} = 1.5V$; $R_{BE} = 100\Omega$)	$I_C = -200mA$ for 2N6489 for 2N6490 for 2N6491	-50 -70 -90			V V V
$V_{CE(sat)}$ * Collector-emitter saturation voltage	$I_C = -5A$; $I_B = -0.5A$ $I_C = -15A$; $I_B = -5A$			-1.3 -3.5	V V
V_{BE} * Base-emitter voltage	$I_C = -5A$ $V_{CE} = -4V$ $I_C = -15A$ $V_{CE} = -4V$			-1.3 -3.5	V V
h_{FE} * DC current gain	$I_C = -5A$ $V_{CE} = -4V$ $I_C = -15A$ $V_{CE} = -4V$	20 5		150	— —
h_{fe} Small signal emitter gain	$I_C = -1A$ $V_{CE} = -4V$ $f = 1MHz$ $I_C = -1A$ $V_{CE} = -4V$ $f = 1KHz$			5 25	— —

* Pulsed: pulse duration = $300\mu s$, duty cycle $\leq 2\%$.

MULTIEPITAXIAL MESA NPN



HIGH VOLTAGE POWER SWITCH

The 2N6544 and 2N6545 are multi-epitaxial mesa NPN transistors in Jedec TO-3 metal case. They are intended for high voltage, fast switching applications.

ABSOLUTE MAXIMUM RATINGS

	2N6544	2N6545
V_{CES}	650V	850V
V_{CEX}	350V	450V
V_{CEO}	300V	400V
V_{EBO}		9V
I_C		8A
I_{CM}		16A
I_B		8A
P_{tot}		125W
T_{stg}		-65 to 200°C
T_j		200°C

INTERNAL SCHEMATIC DIAGRAM

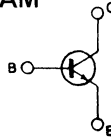

MECHANICAL DATA

Dimensions in mm

Collector connected to case

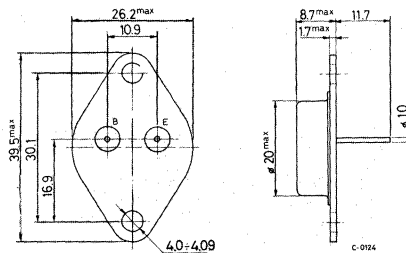

TO-3



2N6544
2N6545

THERMAL DATA

$R_{th\ j-case}$	Thermal resistance junction-case	max. 1.4 °C/W
------------------	----------------------------------	---------------

ELECTRICAL CHARACTERISTICS ($T_{case} = 25^{\circ}C$ unless otherwise specified)

Parameter	Test conditions	Min.	Typ.	Max.	Unit
I_{CES}	Collector cutoff current ($V_{BE} = 0$)	for 2N6544 $V_{CE} = 650V$ for 2N6545 $V_{CE} = 850V$ $T_{case} = 100^{\circ}C$		0.5 0.5	mA mA
I_{CER}	Collector cutoff current ($R_{BE} = 50\Omega$)	$T_{case} = 100^{\circ}C$ for 2N6544 $V_{CE} = 650V$ for 2N6545 $V_{CE} = 850V$		3 3	mA mA
I_{EBO}	Emitter cutoff current ($I_C = 0$)	$V_{EB} = 9V$		1	mA
$V_{CEO(sus)}$ *	Collector-emitter sustaining voltage ($I_B = 0$)	$I_C = 100mA$ for 2N6544 for 2N6545		300 400	V V
$V_{CEX(sus)}$	Collector-emitter sustaining voltage (clamped $E_{s/b}$)	$I_C/I_B = 5$ $L = 180\mu H$ $V_{BE} = -5V$ $T_{case} = 100^{\circ}C$ $V_{clamp} = \text{rated } V_{CEX(sus)}$ $I_C = 4.5A$ for 2N6544 for 2N6545		350 450	V V
		$V_{clamp} = \text{rated } V_{CEO(sus)} - 100V$ $I_C = 8A$ for 2N6544 for 2N6545		200 300	V V
$I_{s/b}$	Second breakdown collector current	$t = 1\text{ s (non repetitive)}$ $V_{CE} = 100V$		0.2	A
$E_{s/b}$	Second breakdown energy	$L = 40\mu H$ $V_{BE} = -4V$ $R_{BE} = 50\Omega$		500	μJ

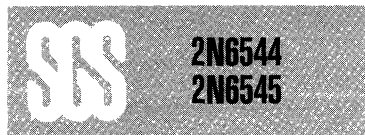

ELECTRICAL CHARACTERISTICS (continued)

Parameter		Test conditions		Min.	Typ.	Max.	Unit
h_{FE}^*	DC current gain	$I_C = 2.5A$ $I_C = 5A$	$V_{CE} = 3V$ $V_{CE} = 3V$	12 7		60 35	— —
$V_{CE(sat)}^*$	Collector-emitter saturation voltage	$I_C = 5A$ $I_C = 8A$ $T_{case} = 100^\circ C$ $I_C = 5A$	$I_B = 1A$ $I_B = 2A$ $I_B = 1A$			1.5 5 2.5	V V V
$V_{BE(sat)}^*$	Base-emitter saturation voltage	$I_C = 5A$ $T_{case} = 100^\circ C$ $I_C = 5A$	$I_B = 1A$ $I_B = 1A$			1.6 1.6	V V
f_T	Transition frequency	$I_C = 0.3A$ $f = 1MHz$	$V_{CE} = 10V$	6		24	MHz
C_{CBO}	Collector-base capacitance	$V_{CB} = 10V$ $f = 1MHz$	$I_E = 0$			200	pF
t_{on}	Turn-on time	RESISTIVE LOAD				1	μS
t_s	Storage time	$I_C = 5A$ $I_{B1} = -I_{B2} = 1A$	$V_C = 250V$			4	μS
t_f	Fall time					1	μS
t_s	Storage time	INDUCTIVE LOAD				4	μS
t_f	Fall time	$I_C = 5A$ (pk) $I_{B1} = 1A$ $L = 180\mu H$ $T_{case} = 100^\circ C$ for 2N6544 for 2N6545	$V_{BE} = -5V$ $V_{clamp} = 350V$ $V_{clamp} = 450V$			0.9	μS

* Pulsed: pulse duration = 300 μs , duty cycle = 1.5%.

For characteristic curves see the BUW 35 type.



2N6546
2N6547

MULTIEPITAXIAL MESA NPN

HIGH VOLTAGE, HIGH CURRENT POWER SWITCH

The 2N6546 and 2N6547 are multiepitaxial mesa NPN transistors in Jedec TO-3 metal case, intended in fast switching applications for high output power.

ABSOLUTE MAXIMUM RATINGS

	2N6546	2N6547
V_{CES}	650V	850V
V_{CEX}	350V	450V
V_{CEO}	300V	400V
V_{EBO}	9V	
I_C	15A	
I_{CM}	30A	
I_B	10A	
P_{tot}	175W	
T_{stg}	-65 to 200°C	
T_j	200°C	

INTERNAL SCHEMATIC DIAGRAM

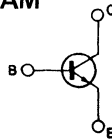

MECHANICAL DATA

Dimensions in mm

Collector connected to case

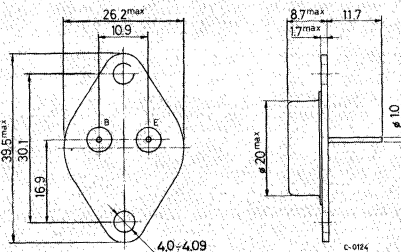

TO-3



THERMAL DATA

$R_{th\ j-case}$	Thermal resistance junction-case	max. 1 °C/W
------------------	----------------------------------	-------------

ELECTRICAL CHARACTERISTICS ($T_{case} = 25^{\circ}C$ unless otherwise specified)

Parameter	Test conditions	Min.	Typ.	Max.	Unit	
I_{CES} Collector cutoff current ($V_{BE} = 0$)	for 2N6546 $V_{CE} = 650V$			1	mA	
	for 2N6547 $V_{CE} = 850V$			1	mA	
	$T_{case} = 100^{\circ}C$					
	for 2N6546 $V_{CE} = 650V$			4	mA	
	for 2N6547 $V_{CE} = 850V$			4	mA	
I_{CER} Collector cutoff current ($R_{BE} = 50\Omega$)	$T_{case} = 100^{\circ}C$					
	for 2N6546 $V_{CE} = 650V$			5	mA	
	for 2N6547 $V_{CE} = 850V$			5	mA	
I_{EBO} Emitter cutoff current ($I_C = 0$)	$V_{EB} = 9V$			1	mA	
$V_{CEO(sus)}$ *Collector-emitter sustaining voltage ($I_B = 0$)	$I_C = 100mA$ for 2N6546 for 2N6547	300			V	
		400			V	
$V_{CEX(sus)}$ *Collector-emitter sustaining voltage (clamped $E_{S/B}$)	$I_C/I_B = 5$ $L = 180\mu H$ $V_{BE} = -5V$ $T_{case} = 100^{\circ}C$ $V_{clamp} = \text{rated } V_{CEX(sus)}$ $I_C = 8A$ for 2N6546 for 2N6547	350			V	
		450			V	
	$V_{clamp} = \text{rated } V_{CEO(sus)} - 100V$ $I_C = 15A$ for 2N6546 for 2N6547	200				V
		300				V
$I_{s/b}$ Second breakdown collector current	$t = 1\ s$ (non repetitive) $V_{CE} = 100V$	0.2			A	
$E_{s/b}$ Second breakdown energy	$L = 40\mu H$ $V_{BE} = -4V$ $R_{BE} = 50\Omega$	2			mJ	



2N6546
2N6547

ELECTRICAL CHARACTERISTICS (continued)

Parameter	Test conditions	Min.	Typ.	Max.	Unit
h_{FE}^* DC current gain	$I_C = 5A$ $V_{CE} = 2V$ $I_C = 10A$ $V_{CE} = 2V$	12 6	60 30	— —	
$V_{CE(sat)}^*$ Collector-emitter saturation voltage	$I_C = 10A$ $I_B = 2A$ $I_C = 15A$ $I_B = 3A$ $T_{case} = 100^\circ C$ $I_C = 10A$ $I_B = 2A$		1.5 5	V V	
$V_{BE(sat)}^*$ Base-emitter saturation voltage	$I_C = 10A$ $I_B = 2A$ $T_{case} = 100^\circ C$ $I_C = 10A$ $I_B = 2A$		1.6 1.6	V V	
f_T Transition frequency	$I_C = 0.5A$ $V_{CE} = 10V$ $f = 1MHz$	6	24		MHz
C_{CBO} Collector-base capacitance	$V_{CB} = 10V$ $I_E = 0$ $f = 1MHz$		360		pF
t_{on} Turn-on time	RESISTIVE LOAD $V_{CC} = 250V$ $I_C = 10A$ $I_{B1} = -I_{B2} = 2A$		1		μs
t_s Storage time			4		μs
t_f Fall time			0.7		μs
t_s Storage time	INDUCTIVE LOAD $I_C = 10A$ (pk) $I_{B1} = 2A$ $V_{BE} = -5V$ $L = 180\mu H$ $T_{case} = 100^\circ C$ for 2N6546 $V_{clamp} = 350V$ for 2N6547 $V_{clamp} = 450V$		5		μs
t_f Fall time			1.5		μs

* Pulsed: pulse duration = 300 μs , duty cycle = 1.5%.

For characteristic curves see the BUW 45 type.



MULTIEPITAXIAL PLANAR NPN

SWITCHING AND GENERAL PURPOSE

The 2N6702 is a silicon multiepitaxial planar NPN transistor and is mounted in Jedec TO-220 plastic package.

It is intended for various switching and general purpose applications.

ABSOLUTE MAXIMUM RATINGS

V_{CEV}	Collector-emitter voltage ($V_{BE} = -1.5\text{ V}$)	140	V
V_{CEO}	Collector-emitter voltage ($I_B = 0$)	90	V
V_{EBO}	Emitter-base voltage ($I_C = 0$)	7	V
I_C	Collector current	7	A
I_{CM}	Collector peak current	10	A
I_B	Base current	5	A
P_{tot}	Total power dissipation ($T_{case} \leq 25^\circ\text{C}$)	50	W
T_{stg}	Storage temperature	-65 to 150	$^\circ\text{C}$
T_j	Junction temperature	150	$^\circ\text{C}$

INTERNAL SCHEMATIC DIAGRAM

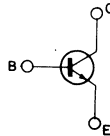

MECHANICAL DATA

Dimensions in mm

Collector connected to tab.

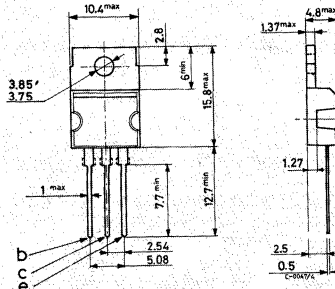

TO-220



2N6702

THERMAL DATA

$R_{th\ j-case}$	Thermal resistance junction-case	max. 2.5 °C/W
------------------	----------------------------------	---------------

ELECTRICAL CHARACTERISTICS ($T_{case} = 25^{\circ}C$ unless otherwise specified)

Parameter	Test conditions	Min.	Typ.	Max.	Unit
I_{CEV}	Collector cutoff current ($V_{BE} = -1.5V$)			100 1	μA mA
I_{EBO}	Emitter cutoff current ($I_C = 0$)			100	μA
$V_{CEO(sus)}^*$	Collector-emitter sustaining voltage ($I_B = 0$)			90	V
$V_{CE(sat)}^*$	Collector-emitter saturation voltage	$I_C = 5A;$ $I_C = 7A;$	$I_B = 0.5A$ $I_B = 0.7A$	0.8 1.5	V V
$V_{BE(sat)}^*$	Base-emitter saturation voltage	$I_C = 5A;$	$I_B = 0.5A$	1.5	V
h_{FE}^*	DC current gain	$I_C = 0.2A;$ $I_C = 5A;$	$V_{CE} = 2V$ $V_{CE} = 2V$	30 20	— —
h_{fe}	Small signal current gain	$I_C = 0.5A;$ $f = 5MHz$	$V_{CE} = 10V$	4 40	—
f_T	Transition frequency	$I_C = 0.5A;$ $f = 5MHz$	$V_{CE} = 10V$	20 200	MHz
C_{CBO}	Collector base capacitance	$I_E = 0;$ $f = 100KHz$	$V_{CB} = 10V$	50 150	pF
$I_{s/b}$	Second breakdown	$V_{CE} = 20V;$ $t = 100\ ms$		2.5	A
t_d	Delay time	$I_C = 5A;$ $V_{CC} = 70V$	$I_{B1} = 0.5A$	0.1	μs
t_r	Rise time			0.25	μs
t_s	Storage time	$I_C = 5A;$ $V_{CC} = 70V$	$I_{B1} = -I_{B2} = 0.5A$	1	μs
t_f	Fall time			0.5	μs

* Pulsed: pulse duration = 300 μs .; duty cycle $\leq 2\%$.

DESIGN AND TECHNICAL NOTES APPLICABLE TO POWER DEVICES

DN300 – HORIZONTAL DEFLECTION IN B/W TV SETS USING THE SGS-ATES DARLINGTONS BU806/7

Horizontal deflection circuits for B/W receivers using the BU806 and BU807 darlington drivers driven by the TDA1180. A short reliability report on the TO-220 plastic package is included.

DN306 – PARALLEL CONNECTION OF HIGH VOLTAGE TRANSISTORS

Connecting high-voltage transistors in parallel; obtaining good performance and reliable operation.

DN307 – AUDIO AMPLIFIERS

Audio amplifiers with output powers of 35W, 50W and 75W using complementary power transistors. Full constructional details are provided.

DN308 – DRIVING CIRCUITS FOR SGS-ATES SWITCHING TRANSISTORS

Driving circuits which optimize the switching efficiency of power stages. This consideration is of particular importance when the duty cycle or switching frequency is variable.

DN323 – BUW34 AND BUW44 HIGH VOLTAGE TRANSISTOR APPLICATIONS: 400W AND 600W SWITCH-MODE MAINS ISOLATED SUPPLIES

The design of two switch-mode regulated supplies: 24V/400W and 24V/600W. Details of the performance and construction are included.

DN328 – OPTIMUM BASE DRIVE VERSUS COLLECTOR CURRENT WAVEFORM

Improving the switching behaviour of power devices for both triangular and trapezoidal collector current waveforms.

DN335 – REVERSE SECONDARY BREAKDOWN

A description of the phenomenon and power transistor ratings for both clamped and unclamped $E_{s/b}$ stresses.

DN336 – DIRECT SECONDARY BREAKDOWN

A description of the $I_{s/b}$ rating in power transistors and how to obtain reliable operation in repetitive pulse conditions.

DN337 – COMPLEMENTARY PAIRS IN SWITCHING APPLICATIONS

The advantages of complementary transistors in circuit design. Includes an application example: a 720W switch-mode converter in bridge configuration.

TN146 – USING THE L200 ADJUSTABLE VOLTAGE AND CURRENT REGULATOR

Description and applications of the L200, versatile variable regulator (2.85 to 36V, 2A max.)

TN150 – 40 INDUSTRIAL APPLICATION IDEAS

Industrial applications for linear integrated circuits and power transistors.

All these Design and Technical Notes can be obtained free of charge from the SGS-ATES sales network.



Information furnished is believed to be accurate and reliable. However, no responsibility is assumed for the consequences of its use nor for any infringement of patents or other rights of third parties which may result from its use. No license is granted by implication or otherwise under any patent or patent rights of SGS-ATES. Specifications mentioned in this publication are subject to change without notice. This publication supersedes and substitutes all information previously supplied.

SGS-ATES GROUP OF COMPANIES

Italy – France – Germany – Malta – Malaysia – Singapore – Sweden – United Kingdom – U.S.A.

© SGS-ATES Componenti Elettronici SpA, 1982 - Printed in Italy

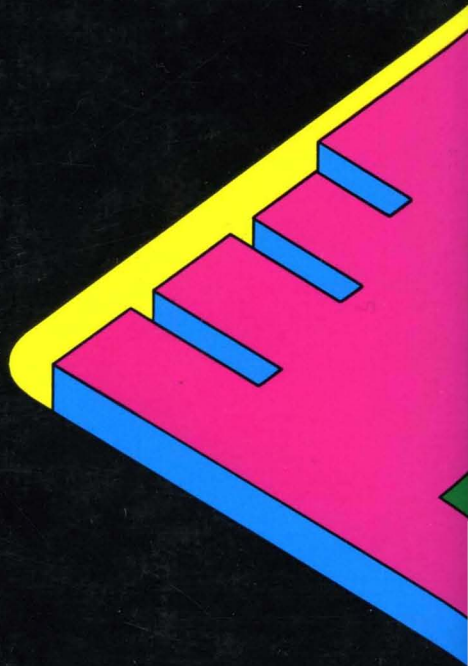

ORDER CODE: DAPWR/5